



FULL LINE CATALOGUE

Innovative Installation Solutions For Video Displays

2016





COMPANY

Edbak Ltd was founded in 1992, and is a leading designer and manufacturer of AV display mounting solutions and accessories. Our off-the-shelf product ranges include flat panel mounts, trolleys and stands, projector mounts, desktop and tablet mounts and kiosks, and environmental enclosures. In addition Edbak specialises in providing bespoke solutions via our dedicated custom design service.

Edbak's ISO 9001 certified facilities combine traditional production techniques with the latest automated machine technologies to deliver TUV certified product quality with speed and precision. Our in-house product design, development and engineering teams give us the flexibility to address multiple vertical markets, and to serve a wide range of customers, including OEM's, commercial integrators, distributors and consumers.

Edward Bæk
President of the Board

■ Designing

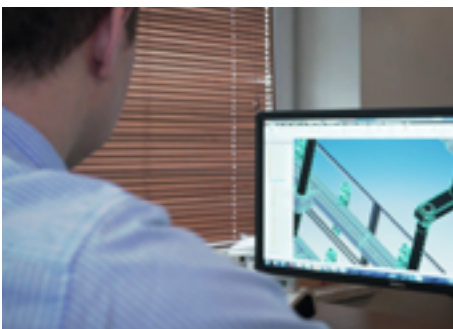

■ Manufacturing



■ R&D





EDBAK – Business Partner Portal

Edbak has designed and developed an automated B2B support portal for our Business Partners. It is directly linked and updated from our SAP system to ensure our partners can access critical information whenever it is needed, available 24/7.

The Business Partner Portal is a comprehensive resource, and covers all aspects of order management, stock status, accounts and invoicing, together with contact details for our support staff.

Key features and advantages include:

- Easy “real time” direct online ordering
- Checking the status of existing orders
- Access to current inventory levels
- Access to account balances, delivery notes, invoices and credits
- Customer and delivery address management
- Direct access to sales and support staff
- Marketing database, featuring product and technical support downloads.

Visit us at:







www.edbakproav.com

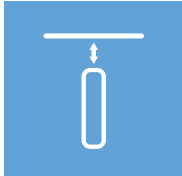
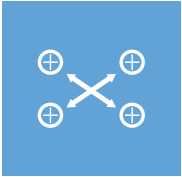
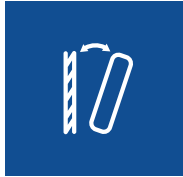
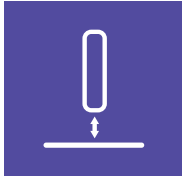

TABLE OF CONTENTS

PROJECTOR MOUNTS	19
TROLLEYS AND STANDS	29
VIDEO WALLS	57
FLAT PANEL WALL MOUNTS	67
MENU BOARDS	95
MONITOR MOUNTS	103
TABLETS	131
INFOKIOSKS AND ENCLOSURES	135







ICONS MAP

	Screen Size		Swivel		Distance from Ceiling
	Mounting Pattern		Tilt		Height Adjustment
	Maximum Load		Distance from Wall		Landscape to Portrait

QUICK REFERENCE CHART

PROJECTOR MOUNTS

► Ceiling

Product	Image	Adjustment range	Max. capacity	Extension range	Colour	Dimensions (HxWxD)	Page
PM1 Universal Projector Ceiling Mount (3 fixing points)		90° / 90°	15 kg	min. 448 mm max. 656 mm	black silver white	656 x 450 x 450 mm	20
PM2 Universal Projector Ceiling Mount (4 fixing points)		90° / 90°	15 kg	min. 448 mm max. 656 mm	black silver white	656 x 480 x 480 mm	20
PM3 Universal Projector Ceiling Mount (3 fixing points)		90° / 90°	15 kg	min. 250 mm max. 300 mm	black silver white	300 x 420 x 420 mm	21
PM8 Universal Projector Ceiling Mount		7,5° / 7,5°	20 kg	650 - 1100 mm	black silver white	1100 x 545 x 545 mm	22
PM8.1 Universal Projector Ceiling Mount		7,5° / 7,5°	20 kg	450 - 650 mm	black silver white	1100 x 545 x 545 mm	22
PM8.2 Universal Projector Ceiling Mount		7,5° / 7,5°	20 kg	1100 - 1950 mm	black silver white	1100 x 545 x 545 mm	22

► Projector Short Throw Wall Mounts

Product	Image	Adjustment range	Max. capacity	Extension range	Colour	Dimensions (HxWxD)	Page
PM7 Universal Projector Wall Mount (3 fixing points)		-15,5° / +10°	15 kg	min. 800 mm max. 1293 mm	black silver	1293 x 93 x 545 mm	21
WPM1 Universal Projector Wall Mount		7,5° / 7,5°	15 kg	800 - 1293 mm	black silver white	1293 x 236 x 545 mm	24

► Projector Theft Delay Housings

Product	Image	Max. capacity	Colour	Dimensions (HxWxD)	Page
PSC21 Indoor Projector Theft Delay Housing - small		15 kg	black silver white	420 x 380 x 230 mm	23





















► Trolleys

Product	Image	Adjustment range	Max. capacity	Extension range	Colour	Dimensions (HxWxD)	Page
PT01 Projector Trolley		-5° / +15°	15 kg	800 - 1293 mm	black silver	1060 x 640 x 220 mm	23



















TROLLEYS AND STANDS

Product	Image	Screen size	VESA (mm)	Max. capacity	Height adjustment	Tilt	Dimensions (HxWxD)	Page
STD01 32"-55" Screen Stand		32"-55"	min. 75x75 max. 600x400	80 kg	min. 310 mm max. 1700 mm	nd	1700 x 800 x 350 mm	29









QUICK REFERENCE CHART

Product	Image	Screen size	VESA (mm)	Max. wpcapacity	Height adjustment	Tilt	Dimensions (HxWxD)	Page
STD02 32"-47" Screen Stand		32"-47"	min. 200x200 max. 600x400	60 kg	1703 mm	nd	1703 x 640 x 238 mm	28
STD03 19"-32" LCD Stand		19"-32"	min. 75x75 max. 100x100	15 kg	1047 mm	0°/45°	1047 x 250 x 250 mm	28
STD04 19"-32" LCD Stand		19"-32"	min. 75x75 max. 100x100	15 kg	1048,5 mm	0°/45°	1048,5 x 559 x 350 mm	30
SV52 19"-27" LCD Stand		19"-27"	min. 75x75 max. 100x100	10 kg	1650 mm	120°	1650 x 664 x 545 mm	31
TR1 42"-70" Flat Screen AV Trolley		42"-70"	min. 75x75 max. 600x400	80 kg	min. 300 mm max. 1700 mm	-6°/+9°	1810 x 1127 x 694 mm	31
STD15 32"-47" Screen Stand		32"-47"	min. 300x300 max. 600x400	30 kg	1200 mm	nd	1200 x 720 x 480 mm	32
STD16 32"-47" Screen Stand		32"-47"	min. 75x75 max. 600x400	30 kg	1880 mm	-6°/+9°	1720 x 800 x 570 mm	32
TR2 42"-70" Flat Screen AV Trolley		42"-70"	min. 75x75 max. 600x400	80 kg	min. 300 mm max. 1700 mm	-6°/+9°	1810 x 1070 x 500 mm	34
TR4 37"-60" Flat Screen AV Trolley		37"-60"	min. 75x75 max. 600x400	80 kg	min. 300 mm max. 1700 mm	-6°/+9°	1700 x 1000 x 500 mm	34
TR5 37"-60" Flat Screen AV Trolley		37"-60"	min. 75x75 max. 600x400	80 kg	min. 250 mm max. 1700 mm	-6°/+9°	1810 x 1144 x 690 mm	33
TR51 37"-60" Flat Screen AV Trolley		37"-60"	min. 75x75 max. 600x400	80 kg	min. 250 mm max. 1700 mm	-6°/+9°	1700 x 1140 x 703 mm	35
TR7 37"-60" Flat Screen AV Trolley		37"-60"	min. 75x75 max. 600x400	80 kg	1606 mm	nd	1606 x 897 x 536 mm	35
TR8 37"-60" Low Level Flat Screen Trolley		37"-60"	min. 75x75 max. 600x400	80 kg	1006 mm	0/+28°	1006 x1070 x 500 mm	36
TR9 37"-60" Flat Screen AV Trolley		37"-60"	min. 100x100 max. 600x400	50 kg	min. 895 mm max. 1710 mm	nd	1784 x 600 x 640 mm	36
TR10 37"-60" Flat Screen AV Trolley		37"-60"	min. 100x100 max. 600x400	50 kg	min. 1360 mm max. 1640 mm	nd	1780 x 1023 x 767 mm	37
TR17 32"-55" Flat Screen AV Trolley		32"-55"	min. 75x75 max. 600x400	50 kg	1590x2390 mm	nd	2390 x 1127 x 694 mm	37
TR18 60"-95" Flat Screen AV Trolley		60"-95"	min. 75x75 max. 600x400	80 kg	1700 mm	nd	1869 x 1705 x 815 mm	38
TR12 37"-60" Dual Flat Screen AV Trolley		37"-60"	min. 100x100 max. 600x400	100 kg	1950 mm	-6,5°/+12°	2083 x 1116 x 802 mm	38
TR3 37"-60" Dual Flat Screen AV Trolley		37"-60"	min. 75x75 max. 600x400	80 kg	min. 200 mm max. 2000 mm	-6°/+9°	2000 x 1070 x 500 mm	39
TR14 40"-47" Dual Flat Screen AV Trolley		40"-47"	min. 75x75 max. 600x400	80 kg	min. 300 mm max. 1600 mm	nd	1850 x 1800 x 815 mm	39

QUICK REFERENCE CHART

Product	Image	Screen size	VESA (mm)	Max. capacity	Height adjustment	Tilt	Dimensions (HxWxD)	Page
TR20 50"-60" Dual Flat Screen AV Trolley		50"-60"	min. 75x75 max. 600x400	80 kg	min. 300 mm max. 1700 mm	nd	1874 x 2200 x 815 mm	40
TR21 32"-37" Dual Flat Screen AV Trolley		32"-37"	min. 75x75 max. 600x400	80 kg	min. 300 mm max. 1700 mm	0/+28°	1805 x 1127 x 694 mm	40
TR6.12 37"-55" Dual Flat Screen AV Trolley		37"-55"	min. 75x75 max. 600x400	120 kg	min. 520 mm max. 1700 mm	-6,5°/+12°	1830 x 1700 x 800 mm	41
TR6.22 37"-55" Quad Flat Screen AV Trolley		37"-55"	min. 75x75 max. 600x400	120 kg	min. 520 mm max. 1700 mm	-6,5°/+12°	1830 x 1700 x 800 mm	41
SV55 19"-27" Flat Screen AV Trolley		19"-27"	75x75 100x100	10 kg	1270 mm	250°	1270 x 690 x 690 mm	42
SV53 19"-27" Universal Adjustable Trolley with PC Mount		19"-27"	75x75 100x100	10 kg	1270 mm	250°	1270 x 690 x 690 mm	42
ETR1 40"-55" Trolley for screen		40"-55"	min. 100x100 max. 600x400	40 kg	min. 1030 mm max. 1850 mm	-6,5°/+12°	1850 x 1144 x 703 mm	43
ETR2 40"-55" Trolley for screen		40"-55"	min. 100x100 max. 600x400	40 kg	min. 1030 mm max. 1850 mm	-6°/+9°	1835 x 1144 x 770 mm	43
ETR3 40"-55" Electric height-adjustable trolley for screen		40"-55"	min. 100x100 max. 600x400	60 kg	min. 100x100 mm max. 600x400 mm	0°/90°	1339 x 782 x 723 mm	44
ETR4 60"-95" Electric height-adjustable trolley for screen		60"-95"	min. 100x100 max. 600x400	60 kg	min. 100x100 mm max. 600x400 mm	0°/90°	1339 x 782 x 723 mm	44
ETRE3 40"-55" Electric height-adjustable trolley for screen		40"-55"	min. 100x100 max. 400x200	60 kg	min. 825 mm max. 1657 mm	0°/90°	1182 x 1657 x 723 mm	44
ETRE4 60"-95" Electric height-adjustable trolley for screen		60"-90"	min. 100x100 max. 800x400	60 kg	min. 825 mm max. 1500 mm	0°/90°	1382 x 1500 x 723 mm	44
EVCT247 40"-47" Video Conferencing Trolley with motorised height adjustment		40"-47"	min. 100x100 max. 600x400	80 kg	min. 950 mm max. 1600 mm	nd	987 x 1718 x 564 mm	45
EVCT255 50"-55" Video Conferencing Trolley with motorised height adjustment		50"-55"	min. 100x100 max. 600x400	80 kg	min. 100x100 mm max. 600x400 mm	nd	1900 x 1718 x 566 mm	45
EVCT155 42"-55" Video Conferencing Trolley with motorised height adjustment		42"-55"	min. 100x100 max. 600x400	80 kg	min. 950 mm max. 1600 mm	nd	987 x 1718 x 564 mm	46
EVCT170 60"-70" Video Conferencing Trolley with motorised height adjustment		60"-70"	min. 100x100 max. 600x400	80 kg	min. 950 mm max. 1600 mm	nd	987 x 1718 x 564 mm	46
EVCT190 79"-90" Video Conferencing Trolley with motorised height adjustment		79"-90"	min. 100x100 max. 800x400	80 kg	min. 100x100 mm max. 600x400 mm	nd	1100 x 1718 x 566 mm	46
VCTR195 65"-95" Video Conferencing Trolley		65"-95"	min. 100x100 max. 600x400	80 kg	1700 mm	nd	1845 x 1705 x 878 mm	45
VCTR237 32"-37" Video Conferencing Trolley for Dual Screens		32"-37"	min. 75x75 max. 600x400	80 kg	min. 1590 mm max. 2390 mm	nd	1805 x 1127 x 694 mm	47





QUICK REFERENCE CHART

Product	Image	Screen size	VESA (mm)	Max. capacity	Height adjustment	Tilt	Dimensions (HxWxD)	Page
VCTR247 40"-47" Video Conferencing Trolley for Dual Screens		40"-47"	min. 100x100 max. 600x400	80 kg	1700 mm	nd	1850 x 1705 x 878 mm	47
VCTR260 50"-60" Video Conferencing Trolley for Dual Screens		50"-60"	min. 75x75 max. 600x400	80 kg	min. 300 mm max. 1700 mm	nd	1874 x 2200 x 815 mm	47
MTR100 65"-70" Mega Trolley		65"-70"	min. 75x75 max. 600x400	120 kg	min. 1100 mm max. 1500 mm	nd	1520 x 860 x 700 mm	48
MTR101 80"-85" Mega Trolley		80"-85"	min. 100x100 max. 800x400	120 kg	min. 1100 mm max. 1500 mm	nd	1700 x 1110 x 870 mm	48
VCTX155 42"-55" Video Conferencing Trolley		42"-55"	min. 100x100 max. 600x400	80 kg	min. 1000 mm max. 1800 mm	nd	1100 x 1958 x 873 mm	49
VCTX170 60"-70" Video Conferencing Trolley		60"-70"	min. 100x100 max. 800x400	80 kg	min. 1000 mm max. 1800 mm	nd	1100 x 1958 x 873 mm	49
VCTX190 79"-90" Video Conferencing Trolley		79"-90"	min. 100x100 max. 800x400	80 kg	min. 1000 mm max. 1800 mm	nd	1100 x 1958 x 873 mm	49
VCTX247 40"-47" Video Conferencing Trolley for Dual Screens		40"-47"	min. 100x100 max. 600x400	80 kg	min. 1000 mm max. 1800 mm	nd	1900 x 1958 x 873 mm	48
VCTX255 50"-55" Video Conferencing Trolley for Dual Screens		50"-55"	min. 200x100 max. 600x400	80 kg	min. 1000 mm max. 1800 mm	nd	1900 x 1958 x 873 mm	48

VIDEO WALLS

Product	Image	Screen size	VESA (mm)	Max. capacity	Height adjustment	Tilt	Dimensions (HxWxD)	Page	
VWPOP Series		VWPOP65-L Quick Release Pop-Out Universal Video Wall Mount	42-65"	max. 400-600 mm	60 kg	85 - 270 mm	-0/+28°	824 x 530 x 80 mm	54
		VWPOP85-L Quick Release Pop-Out Universal Video Wall Mount	70-95"	max. 600-400 mm	80 kg	100 - 310 mm	-0/+28°	1084 x 700 x 100 mm	54
		VWPOP95-L Quick Release Pop-Out Universal Video Wall Mount	70-95"	max. 800-600 mm	120 kg	85 - 270 mm	-0/+28°	876 x 670 x 100 mm	54
VWFS Series		VWFS65-L Full Service Universal Video Wall	42-65"	max. 600-400 mm	60 kg	85 - 270 mm	-0/+28°	824 x 500 x 80 mm	56
		VWFS85-L Full Service Universal Video Wall	70-85"	max. 600-400 mm	80 kg	85 - 270 mm	-0/+28°	824 x 500 x 80 mm	56
		VWFS95-L Full Service Universal Video Wall	90-95"	max. 800-600 mm	130 kg	85 - 270 mm	-0/+28°	1070 x 670 x 100 mm	56
VWFX Series		VWFX65-L Fixed Universal Video Wall Mount, Landscape	42-65"	max. 600-400 mm	60 kg	7,5 mm	nd	862 x 500 x 80 mm	57
		VWFX85-L Fixed Universal Video Wall Mount, Landscape	70-85"	max. 600-400 mm	80 kg	7,5 mm	nd	862 x 500 x 80 mm	57
		VWFX95-L Fixed Universal Video Wall Mount, Landscape	90-95"	max. 800-600 mm	130 kg	7,5 mm	nd	1076 x 670 x 100 mm	57

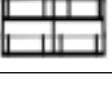
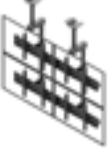
QUICK REFERENCE CHART

Product		Image	Screen size	VESA (mm)	Max. capacity	Height adjustment	Tilt	Dimensions (HxWxD)	Page
VWPOP Series	VWPOP65-P Quick Release Pop-Out Universal Video Wall Mount		40"-65"	max. 400-600 mm	60 kg	85 - 270 mm	-0/+28°	512 x 530 x 80 mm	58
	VWPOP85-P Quick Release Pop-Out Universal Video Wall Mount		70"-85"	max. 400-300 mm	80 kg	85 - 270 mm	-0/+28°	512 x 530 x 80 mm	58
	VWPOP95-P Quick Release Pop-Out Universal Video Wall Mount		90"-95"	max. 600-600 mm	130 kg	85 - 270 mm	-0/+28°	876 x 670 x 100 mm	58
VWFS Series	VWFS65-P Quick Release Pop-Out Universal Video Wall Mount		42"-65"	max. 400-600 mm	60 kg	85 - 270 mm	-0/+28°	512 x 500 x 80 mm	60
	VWFS85-P Quick Release Pop-Out Universal Video Wall Mount		70"-85"	max. 400-300 mm	80 kg	85 - 270 mm	-0/+28°	512 x 500 x 80 mm	60
	VWFS95-P Quick Release Pop-Out Universal Video Wall Mount		90"-95"	max. 600-600 mm	130 kg	85 - 270 mm	-0/+28°	876 x 670 x 100 mm	60
VWFX Series	VWFX65-P Fixed Universal Video Wall Mount, Portrait		42"-65"	max. 400-300 mm	60 kg	85 - 270 mm	nd	2550 x 1200 x 900 mm	61
	VWFX85-P Fixed Universal Video Wall Mount, Portrait		70"-85"	max. 600-400 mm	80 kg	85 - 270 mm	nd	514 x 500 x 80 mm	61
	VWFX95-P Fixed Universal Video Wall Mount, Portrait		90"-95"	max. 600-600 mm	130 kg	85 - 270 mm	nd	8760 x 670 x 100 mm	61
VWW2255POP-L Video Wall pop-out for 4 screens 50"-55", Landscape			50"-55"	min. 100 x 100 mm max. 400 x 600 mm	200 kg	min. 100x100 mm max. 600x400 mm	nd	2100 x 1210 x 100 mm	62
VWC Series	VWC2247-L Ceiling Video Walls, Landscape		40"-47"	min. 100 x 100 mm max. 600 x 400 mm	200 kg	100 - 1300 mm	nd	2000 x 1800 x 330 mm	63
	VWC2257-L Ceiling Video Walls, Landscape		50"-57"	min. 100 x 100 mm max. 600 x 400 mm	180 kg	100 - 1300 mm	nd	2200 x 2200 x 330 mm	63
	VWC2347-L Ceiling Video Walls, Landscape		40"-47"	min. 100 x 100 mm max. 600 x 400 mm	180 kg	100 - 1900 mm	nd	2600 x 1800 x 330 mm	63
	VWC2357-L Ceiling Video Walls, Landscape		50"-57"	min. 100 x 100 mm max. 600 x 400 mm	160 kg	100 - 1900 mm	nd	2800 x 2200 x 330 mm	63
	VWC3247-L Ceiling Video Walls, Landscape		40"-47"	min. 100 x 100 mm max. 600 x 400 mm	300 kg	100 - 1300 mm	nd	2000 x 2700 x 330 mm 2200 x 3300 x 330 mm	63
	VWC3257-L Ceiling Video Walls, Landscape		50"-57"	min. 100 x 100 mm max. 600 x 400 mm	270 kg	100 - 1300 mm	nd	2200 x 3300 x 330 mm	63
	VWC3347-L Ceiling Video Walls, Landscape		40"-47"	min. 100 x 100 mm max. 600 x 400 mm	280 kg	100 - 1900 mm	nd	2600 x 2800 x 330 mm	63
	VWC3357-L Ceiling Video Walls, Landscape		50"-57"	min. 100 x 100 mm max. 600 x 400 mm	250 kg	100 - 1900 mm	nd	2800 x 3300 x 330 mm	63
VWT Series	VWT2247-L Fixed Universal Video Wall Mount, Landscape		40"-47"	min. 100 x 100 mm max. 600 x 400 mm	220 kg	100 - 1300 mm	nd	1970 x 1800 x 900 mm	64
	VWT2257-L Fixed Universal Video Wall Mount, Landscape		50"-57"	min. 100 x 100 mm max. 600 x 400 mm	210 kg	100 - 1300 mm	nd	1970 x 2200 x 900 mm	64
	VWT2347-L Fixed Universal Video Wall Mount, Landscape		40"-47"	min. 100 x 100 mm max. 600 x 400 mm	205 kg	100 - 1900 mm	nd	2570 x 1800 x 900 mm	64
	VWT2357-L Fixed Universal Video Wall Mount, Landscape		50"-57"	min. 100 x 100 mm max. 600 x 400 mm	190 kg	100 - 1900 mm	nd	2570 x 2200 x 900 mm	64
	VWT3247-L Fixed Universal Video Wall Mount, Landscape		40"-47"	min. 100 x 100 mm max. 600 x 400 mm	305 kg	100 - 1300 mm	nd	1970 x 2700 x 900 mm	64
	VWT3257-L Fixed Universal Video Wall Mount, Landscape		50"-57"	min. 100 x 100 mm max. 600 x 400 mm	305 kg	100 - 1300 mm	nd	1970 x 3300 x 900 mm	64
	VWT3347-L Fixed Universal Video Wall Mount, Landscape		40"-47"	min. 100 x 100 mm max. 600 x 400 mm	305 kg	100 - 1900 mm	nd	2570 x 2700 x 900 mm	64
	VWT3357-L Fixed Universal Video Wall Mount, Landscape		50"-57"	min. 100 x 100 mm max. 600 x 400 mm	290 kg	100 - 1900 mm	nd	2570 x 3300 x 900 mm	64

QUICK REFERENCE CHART

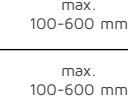
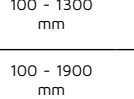
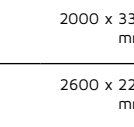
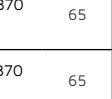













Product		Image	Screen size	VESA (mm)	Max. capacity	Height adjustment	Tilt	Dimensions (HxWxD)	Page
VWS Landscape Series	VWS2247-L Video Wall Stand, Landscape		40-47"	max. 100-600 mm	220 kg	100 - 1300 mm	nd	2000 x 1800 x 370 mm	65
	VWS2257-L Video Wall Stand, Landscape		50-57"	max. 100-600 mm	210 kg	100 - 1300 mm	nd	2000 x 2200 x 370 mm	65
	VWS2347-L Video Wall Stand, Landscape		40-47"	max. 100-600 mm	220 kg	100 - 1900 mm	nd	2600 x 1800 x 370 mm	65
	VWS2357-L Video Wall Stand, Landscape		50-57"	max. 100-600 mm	210 kg	100 - 1900 mm	nd	2600 x 2200 x 370 mm	65
	VWS3247-L Video Wall Stand, Landscape		40-47"	max. 100-600 mm	300 kg	100 - 1300 mm	nd	2000 x 2700 x 370 mm	65
	VWS3257-L Video Wall Stand, Landscape		50-57"	max. 100-600 mm	280 kg	100 - 1300 mm	nd	2000 x 3300 x 370 mm	65
	VWS3347-L Video Wall Stand, Landscape		40-47"	max. 100-600 mm	185 kg	100 - 1900 mm	nd	2600 x 2200 x 370 mm	65
	VWS3357-L Video Wall Stand, Landscape		50-57"	max. 100-600 mm	280 kg	100 - 1900 mm	nd	2600 x 3300 x 370 mm	65
VWFC Landscape Series	VWFC2247-L Video Wall Ceiling - Floor Mounted, Landscape		40-47"	max. 100-600 mm	220 kg	100 - 1300 mm	nd	3000 x 1900 x 260 mm	66
	VWFC2257-L Video Wall Ceiling - Floor Mounted, Landscape		50-57"	max. 100-600 mm	210 kg	100 - 1300 mm	nd	3000 x 1900 x 260 mm	66
	VWFC2347-L Video Wall Ceiling - Floor Mounted, Landscape		40-47"	max. 100-600 mm	220 kg	100 - 1900 mm	nd	3000 x 1900 x 260 mm	66
	VWFC2357-L Video Wall Ceiling - Floor Mounted, Landscape		50-57"	max. 100-600 mm	210 kg	100 - 1900 mm	nd	3000 x 1900 x 260 mm	66
	VWFC3247-L Video Wall Ceiling - Floor Mounted, Landscape		40-47"	max. 100-600 mm	220 kg	100 - 1300 mm	nd	3000 x 3000 x 260 mm	66
	VWFC3257-L Video Wall Ceiling - Floor Mounted, Landscape		50-57"	max. 100-600 mm	210 kg	100 - 1300 mm	nd	3000 x 3000 x 260 mm	66
	VWFC3347-L Video Wall Ceiling - Floor Mounted, Landscape		40-47"	max. 100-600 mm	220 kg	100 - 1900 mm	nd	3000 x 3000 x 260 mm	66
	VWFC3357-L Video Wall Ceiling - Floor Mounted, Landscape		50-57"	max. 100-600 mm	210 kg	100 - 1900 mm	nd	3000 x 3000 x 260 mm	66
VWC Portrait Series	VWC2247-P Video Wall Ceiling - Floor Mounted, Landscape		40-47"	max. 100-600 mm	200 kg	100 - 1300 mm	nd	2700 x 1200 x 330 mm	67
	VWC2257-P Video Wall Ceiling - Floor Mounted, Landscape		50-57"	max. 100-600 mm	180 kg	100 - 1300 mm	nd	2700 x 2400 x 330 mm	67
	VWC2347-P Video Wall Ceiling - Floor Mounted, Landscape		40-47"	max. 100-600 mm	300 kg	100 - 1900 mm	nd	2700 x 1800 x 260 mm	67
	VWC2357-P Video Wall Ceiling - Floor Mounted, Landscape		50-57"	max. 100-600 mm	160 kg	100 - 1900 mm	nd	2700 x 1800 x 260 mm	67
VWT Portrait Series	VWT2247-P Video Wall Trolley, Portrait		40-47"	max. 100-600 mm	100 kg	100 - 1300 mm	nd	2550 x 1200 x 900 mm	68
	VWT2257-P Video Wall Trolley, Portrait		50-57"	max. 100-600 mm	110 kg	100 - 1300 mm	nd	2550 x 1400 x 900 mm	68
	VWT2347-P Video Wall Trolley, Portrait		40-47"	max. 100-600 mm	130 kg	100 - 1900 mm	nd	2550 x 1800 x 900 mm	68
	VWT2357-P Video Wall Trolley, Portrait		50-57"	max. 100-600 mm	140 kg	100 - 1900 mm	nd	2550 x 1800 x 900 mm	68
VWS Portrait Series	VWS2247-P Video Wall Stand, Portrait		40-47"	max. 100-600 mm	220 kg	100 - 1300 mm	nd	2600 x 1100 x 370 mm	69
	VWS2257-P Video Wall Stand, Portrait		50-57"	max. 100-600 mm	210 kg	100 - 1300 mm	nd	2700 x 2400 x 330 mm	69
	VWS2347-P Video Wall Stand, Portrait		40-47"	max. 100-600 mm	220 kg	100 - 1900 mm	nd	2600 x 1100 x 370 mm	69
	VWS2357-P Video Wall Stand, Portrait		50-57"	max. 100-600 mm	210 kg	100 - 1900 mm	nd	2600 x 1400 x 370 mm	69

QUICK REFERENCE CHART



Product		Image	Screen size	VESA (mm)	Max. capacity	Height adjustment	Tilt	Dimensions (HxWxD)	Page
VWFC Portrait Series	VWFC2247-P Video Wall Ceiling-Floor Mounted, Portrait		40-47"	max. 100-600 mm	100 kg	100 - 1300 mm	nd	3000 x 1200 x 260 mm	70
	VWFC2257-P Video Wall Ceiling-Floor Mounted, Portrait		50-57"	max. 100-600 mm	110 kg	100 - 1300 mm	nd	3000 x 1400 x 260 mm	70
	VWFC3247-P Video Wall Ceiling-Floor Mounted, Portrait		40-47"	max. 100-600 mm	135 kg	100 - 1900 mm	nd	3000 x 1800 x 260 mm	70
	VWFC3257-P Video Wall Ceiling-Floor Mounted, Portrait		50-57"	max. 100-600 mm	150 kg	100 - 1900 mm	nd	3000 x 1800 x 260 mm	70

FLAT PANEL WALL MOUNTS









▶ Super Slim Fixed Wall Mounts / Fixed Wall Mounts / Tilting Wall Mounts / Wall Mounting System

Product	Image	Screen size	VESA (mm)	Max. capacity	Height adjustment	Tilt	Dimensions (HxWxD)	Page
ECB300 37"-46" Superslim Wall Mount		37"-46"	min. 100x100 max. 400x400	25 kg	25 mm	nd	440 x 484 x 25 mm	72
EWB100 26"-40" Fixed Wall Mount		26"-40"	min. 75x75 max. 400x200	40kg	25,5 mm	nd	495 x 370 x 25,5 mm	72
EWB200 40"-65" Fixed Wall Mount		40"-65"	min. 75x75 max. 800x400	40 kg	25,5 mm	nd	850 x 470 x 25,5 mm	73
PSM1 37"-65" Fixed Wall Mount		37"-65"	min. 75x75 max. 800x400	40 kg	25 mm	nd	865 x 500 x 25 mm	73
XSM1 37"-65" Fixed Wall Mount		37"-65"	min. 75x75 max. 800x400	60 kg	23,75 mm	nd	894 x 500 x 23,75 mm	74
LWB1 26"-42" Fixed Wall Mount		26"-42"	min. 75x75 max. 400x200	60 kg	41 mm	nd	540 x 260 x 41 mm	74
PWB1 42"-60" Fixed Wall Mount		42"-60"	min. 100x100 max. 600x400	80 kg	41 mm	nd	800 x 500 x 41 mm	75
TWB1 65"-75" Fixed Wall Mount		65"-75"	min. 75x75 max. 800x400	80kg	41 mm	nd	900 x 500 x 48,5 mm	75
XWB1 80"-95" Fixed Wall Mount		80"-95"	min. 200x200 max. 1200x400	110 kg	42 mm	nd	1260x540x42 mm	76
LWB3 26"-40" Portrait Wall Mount		26"-40"	min. 75x75 max. 400x200	60 kg	41 mm	nd	1260 x 540 x 42 mm	76
PWB3 42"-60" Portrait Wall Mount		42"-60"	min. 100x100 max. 600x400	80 kg	44,6 mm	nd	458 x 780 x 44,6 mm	77
TWB3 65"-75" Portrait Wall Mount		65"-75"	min. 100x100 max. 800x400	80 kg	44,6 mm	nd	550 x 950 x 44,6 mm	77
XWB3 80"-95" Portrait Wall Mount		80"-95"	min. 200x100 max. 800x400	80 kg	41 mm	nd	600 x 1245 x 41 mm	78
LWB2 26"-40" Tilt Wall Mount		26"-40"	min. 75x75 max. 400x200	60 kg	75,33 mm	-6°/+12°	540 x 300 x 41 mm	78
PWB2 42"-60" Tilt Wall Mount		42"-60"	min. 100x100 max. 600x400	80 kg	77,4 mm	-6°/+12°	800 x 500 x 77,4 mm	79







QUICK REFERENCE CHART

TWB2 60"-65" Tilt Wall Mount		60"-65"	min. 100x100 max. 800x400	80 kg	77,4 mm	-6°/+11°	910 x 220 x 75 mm	79
EWB250 42"-65" Tilt Wall Mount		42"-65"	min. 75x75 max. 800x400	40 kg	48,75 mm	0°/+12°	850 x 470 x 48,75 mm	80



► Thin Swing Arm Wall Mounts / Swing Arm Wall Mounts / Heavy Duty Swing Arms















Product	Image	Screen size	Max. capacity	VESA (mm)	Adjustment possibility	Extension	Dimensions (HxWxD)	Page
LWR1 26"-40" Swing Arm Wall Mount		26"-40"	60 kg	min. 75x75 max. 400x200	-6°/+9°	456 mm	456 x 540 x 300 mm	80
PWS2 32"-50" Swing Arm Wall Mount		32"-50"	25 kg	min. 200x200 max. 400x200	0°/+10°	62/638 mm	638 x 660 x 440 mm	81
RMSA1 42"-90" Heavy Duty Swing Arm Wall Mount		42"-90"	120 kg	min. 100x100 max. 600x400	-10°/+10°	min. 150 mm max. 700 mm	700 x 850 x 520 mm	82
LWS1 26"-40" Swing Arm Wall Mount		26"-40"	60 kg	min. 75x75 max. 400x200	-6°/+9°	min. 197 mm max. 611 mm	611 x 540 x 300 mm	83
PWR1 42"-55" Swing Arm Wall Mount		42"-55"	80 kg	min. 100x100 max. 400x400	-6°/+9°	458 mm	458 x 800 x 500 mm	83
PWS1 42"-55" Swing Arm Wall Mount		42"-55"	80 kg	min. 100x100 max. 400x400	-6°/+9°	613 mm	613 x 800 x 500 mm	84
RPWS1 42"-70" Heavy Duty Swing Arm Wall Mount		42"-70"	120 kg	min. 100x100 max. 600x400	-10°/+10°	min. 150 mm max. 800 mm	800 x 980 x 520 mm	84
PWS3 42"-60" Dual Swing Arm Wall Mount		42"-60"	80 kg	min. 100x100 max. 600x400	-6°/+9°	min. 169 mm max. 817 mm	734 x 800 x 500 mm	86
PWS4 42"-60" Dual Swing Arm Wall Mount		42"-60"	80 kg	min. 100x100 max. 600x400	-6°/+9°	min. 150 mm max. 800 mm	783 x 800 x 500 mm	86
CPWS1 42"-65" Corner Rotating Swing Arm Wall Mount		42"-65"	120 kg	min. 100x100 max. 600x400	-10°/+10°	min. 150 mm max. 800 mm	800 x 980 x 520 mm	88

► Flat Screen Ceiling Mounts

Product	Image	Screen size	Max. capacity	VESA (mm)	Adjustment possibility	Extension	Dimensions (HxWxD)	Page
CMLS2 32"-47" Adjustable Ceiling Mount		32"-47"	30 kg	min. 100x100 max. 600x400	-0°/+22°	min. 1332 mm max. 1770 mm	1170 x 800 x 183 mm	85
CMS21 26"-55" Adjustable Ceiling Mount		26"-55"	60 kg	min. 100x100 max. 600x400	-12,5°/+6,5°	min. 1775 mm max. 2575 mm	2175 x 800 x 200 mm	87
CMS1 32"-65" LCD Ceiling Mount		32"-65"	60 kg	min. 100x100 max. 600x400	-12,5°/+6,5°	1677 mm	1677 x 800 x 200 mm	88
CMS2 32"-65" Adjustable Ceiling Mount		32"-65"	60 kg	min. 100x100 max. 600x400	-12,5°/+6,5°	min. 1775 mm max. 2575 mm	1775 x 800 x 200 mm	89
CMS3 32"-65" Dual Ceiling Mount		32"-65"	120 kg	min. 75x75 max. 400x200	-12°/+6,5°	min. 1450 mm max. 2250 mm	1450 x 800 x 326 mm	89
CMS4 37"-55" Large Triple Ceiling Multi Directional Mount		37"-55"	120 kg	min. 100x100 max. 600x400	12,5°/+6,5°	1355 mm	1355 x 800 x 269,5 mm	90

QUICK REFERENCE CHART

► Flat Screen Desk Mount								
Product	Image	Screen size	Max. capacity	VESA (mm)	Adjustment possibility	Extension	Dimensions (HxWxD)	Page
MSV1 32"-46" MSV1 Screen Desk Mount		32"-46"	15 kg	min. 75x75 max. 200x200	40°	405 mm	405 x 220 x 120,5 mm	90
MSV2 32"-46" MSV2 Screen Desk Mount		32"-46"	15 kg	min. 75x75 max. 200x200	40°	405 mm	705 x 220 x 120,5 mm	91

MENU BOARDS						
Product	Image	Screen size	Adjustment range	Max. capacity	Extension range	Page
MB1155-L 40"-55" Ceiling Menu board for x1 screen, Landscape		40"-55"	0°/+18°	60 kg	1500 mm	94
MB2155-L 40"-55" Ceiling Menu board for x2 screens, Landscape		40"-55"	0°/+18°	120 kg	1500 mm	94
MB3155-L 40"-55" Ceiling Menu board for x3 screens, Landscape		40"-55"	0°/+18°	120 kg	1500 mm	95
MB1155BB-L 40"-55" Ceiling Menu board for back to back screen, Landscape		40"-55"	0°/+18°	180 kg	1500 mm	95
MB3155BB-L 40"-55" Ceiling Menu board for x3 back to back screens, Landscape		40"-55"	0°/+18°	160 kg	1500 mm	96
MB2155BB-L 40"-55" Ceiling Menu board for x2 back to back screens, Landscape		40"-55"	0°/+18°	240 kg	1500 mm	96
MB1155-P 40"-55" Ceiling Menu board for x3 back to back screens, Landscape		40"-55"	0°/+18°	60 kg	1500 mm	97
MB2155-P 40"-55" Ceiling Menu board for x2 screens, Portrait		40"-55"	0°/+18°	120 kg	1500 mm	97
MB1155BB-P 40"-55" Ceiling Menu board for back to back screens, Portrait		40"-55"	0°/+18°	120 kg	1500 mm	98
MB2155BB-P 40"-55" Ceiling Menu board for x2 back to back screens, Portrait		40"-55"	0°/+18°	240 kg	1500mm	98
MB155W-L 40"-55" Menu board for multiscreens configuration wall mount, Landscape		40"-55"	0°/+18°	60 kg	1500 mm	99
MB355T-L 40"-55" Ceiling Menu board for x3 screens, triangle, Landscape		40"-55"	0°/+18°	180 kg	1500mm	99
MB455Q-L 40"-47" Ceiling Menu board for x4 screens, Squared, Landscape		40"-47"	0°/+18°	240 kg	1500 mm	100
MB455BBS-L 40"-55" Ceiling Menu board for x4 screens, back-to back, stacked mounts, Landscape		40"-55"	0°/+18°	240 kg	1500 mm	100



QUICK REFERENCE CHART

MONITOR MOUNTS















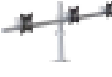

► Wall Monitor Mounts

Product	Image	Screen size	Adjustment range	Max. capacity	Extension range	Dimensions (HxWxD)	Page
GD22 19"-27" LCD Fixed Wall Mount		19"-27"	nd	10 kg	18 mm	201,5 x 150 x 18 mm	102
GD01 19"-27" LCD Swing Arm Wall Mount		19"-27"	180°	10 kg	min. 108 mm max. 472 mm	472 x 178 x 115 mm	102
GD02 19"-27" LCD Swing Arm Wall Mount		19"-27"	180°	10 kg	min. 108 mm max. 307 mm	307 x 178 x 115 mm	103
GD03 19"-27" LCD Wall Mount		19"-27"	nd	10 kg	25 mm	115 x 115 x 25 mm	103
GD04 19"-27" LCD Tilting Wall Mount		19"-27"	180°	10 kg	106 mm	115 x 115 x 106 mm	104
GD18 19"-27" LCD Swing Arm Wall Mount		19"-27"	180°	10 kg	min. 108 mm max. 792 mm	792 x 219 x 115 mm	111
GD20 19"-27" LCD Tilting Wall Mount		19"-27"	140°	10 kg	124 mm	174 x 126 x 124 mm	105
GD24 19"-27" LCD Multi Purpose Mount		19"-27"	145°	10 kg	91 mm	115 x 115 x 91 mm	105
GD25 19"-27" LCD Swing Arm Wall Mount		19"-27"	100°	10 kg	min. 108 mm max. 305 mm	305 x 159 x 125 mm	106
GD26 19"-27" LCD Swing Arm Wall Mount		19"-27"	100°	10 kg	600 mm	600 x 238 x 147 mm	106
MWM111 19"-27" LCD Wall Mount with gas spring		19"-27"	-90°/+90°	10 kg	min. 52 mm max. 460 mm	460 x 551 x 52 mm	107
MWM121 19"-27" LCD Wall Mount with gas spring		19"-27"	-90°/+90°	10 kg	min. 52 mm max. 684 mm	684 x 538 x 52 mm	107
MWM131 19"-27" LCD Wall Mount with gas spring		19"-27"	-90°/+90°	10 kg	min. 52 mm max. 908 mm	908 x 615 x 52 mm	108
MWM221 19"-27" LCD Wall Mount with gas spring		19"-27"	-90°/+90°	10 kg	min. 52 mm max. 532 mm	1064 x 715 x 52 mm	108

► Desk Monitor Mounts







Product	Image	Screen size	Adjustment range	Max. capacity	Dimensions (HxWxD)	Page
GD12 19"-27" LCD Desk Mount		19"-27"	-90°/+90°	10 kg	310 x 70 x 70 mm	109
SV01 19"-27" LCD Desk Mount		19"-27"	250°	10 kg	405 x 125 x 116 mm	109

QUICK REFERENCE CHART

Product	Image	Screen size	Adjustment range	Max. capacity	Dimensions (HxWxD)	Page
SV02 19"-27" LCD Desk Mount with gas spring		19"-27"	250°	10 kg	405 x 125 x 366 mm	110
SV03 19"-27" LCD Desk Mount		19"-27"	160°	10 kg	405 x 125 x 700 mm	110
SV04 19"-27" LCD Desk Mount		19"-27"	250°	10 kg	405 x 125 x 528 mm	116
SV29 19"-27" LCD Slim Pole Desk Mount		19"-27"	-90°/+30°	10 kg	875 x 125 x 45 mm	115
SV30 19"-27" LCD Slim Pole Desk Mount		19"-27"	-90°/+30°	10 kg	450 x 125 x 45 mm	115
SV05 19"-27" Dual LCD Desk Mount		19"-27"	160°	20 kg	405 x 750 x 107 mm	113
SV06 19"-27" Dual LCD Desk Mount		19"-27"	150°	20 kg	405 x 1050 x 107 mm	119
SV07 19"-27" Quad-LCD Desk Mount		19"-27"	160°	40 kg	705 x 7500 x 107 mm	113
SV08 19"-27" Dual LCD Desk Mount		19"-27"	250°	20 kg	705 x 125 x 116 mm	114
SV09 19"-27" Triple LCD Desk Mount		19"-27"	160°	30 kg	405 x 1200 x 120 mm	114
SV10 19"-27" Triple LCD Desk Mount		19"-27"	160°	30 kg	405 x 1400 x 108 mm	115
SV11 19"-27" Triple LCD Desk Mount		19"-27"	160°	30 kg	405 x 1490 x 108 mm	115
SV20 19"-27" LCD Desk Mount for Dual LCD's Back to Back		19"-27"	-90°/+90°	10 kg	405 x 700 x 700 mm	117
MDM121 19"-27" LCD Desk Mount with gas spring		19"-27"	-90°/+90°	20 kg	684 x 636 x 119 mm	117
SV16 19"-27" Hexa-LCD Desk Mount		19"-27"	160°	60 kg	705 x 1400 x 108 mm	118
SV17 19"-27" Hexa-LCD Desk Mount		19"-27"	160°	60 kg	705 x 1490 x 108 mm	118
MDM221 19"-27" Dual LCD Swing Arm Desk Mount with gas spring		19"-27"	-90°/+90°	20 kg	636 x 1064 x 119 mm	120

QUICK REFERENCE CHART

► Medical Monitor Mounts / Undershelf Monitor Mounts / Ceiling Monitor Mounts



Product	Image	Screen size	Adjustment range	Max. capacity	Extension range	Dimensions (HxWxD)	Page
MSA01 19"-27" Dual LCD Swing Arm Desk Mount with gas spring		19"-27"	22,5°/-22,5°	10 kg	1744 mm	1744 x 2545 x 2490 mm	123
MSA02 19"-27" Swing Arm Wall Mount		19"-27"	22,5°/-22,5°	10 kg	1610 mm	1610 x 884 x 160 mm	120
USM1 19"-27" Under Shelf LCD Arm		19"-27"	-12°/+90°	10 kg	299 mm	299 x 150 x 115 mm	121
SV31 19"-27" LCD Ceiling Mount		19"-27"	120°	10 kg	730 mm	730 x 119 x 135 mm	121
SV34 19"-27" LCD Adjustable Ceiling Mount		19"-27"	120°	10 kg	1020/1720 mm	1720 x 119 x 145 mm	122
SV35 19"-27" Dual LCD Ceiling Mount		19"-27"	120°	20 kg	1020/1720 mm	1720 x 119 x 145 mm	122

TABLETS











► Tablet Enclosures

Product	Image	Max. capacity	Weight	Dimensions (HxWxD)	Page
IPM01 Tablet Mount		5 kg	0,8 kg	270 x 250 x 30 mm	126
ITE1001 10" Indoor Tablet Enclosure		-	1 kg	275 x 202 x 34 mm	126
ITE02 Tablet Enclosure		3 kg	7 kg	200 x 300 x 280 mm	127
ITE03 Tablet Enclosure		10 kg	4 kg	custom	127

► Stands

Product	Image	Max. capacity	Weight	Dimensions (HxWxD)	Page
ITSV01 ITSV Series Tablet Stands with VESA Adapter		5 kg	9 kg	400 x 400 x 1190 mm	128
ITSV02 ITSV Series Tablet Stands with VESA Adapter		5 kg	15 kg	350 x 350 x 1030 mm	128
ITSV02L ITSV Series Tablet Stands with VESA Adapter		5 kg	15 kg	350 x 350 x 1030 mm	128
ITSV03 ITSV Series Tablet Stands with VESA Adapter		8 kg	19 kg	400 x 450 x 1030 mm	129

QUICK REFERENCE CHART



Product	Image	Max. capacity	Weight	Dimensions (HxWxD)	Page
ITSV03L ITSV Series Tablet Stands with VESA Adapter		8 kg	19 kg	400 x 450 x 1030 mm	129
ITSV03P ITSV Series Tablet Stands with VESA Adapter		8 kg	19 kg	400 x 450 x 1030 mm	129
ITS02 ITS Series Tablet Stand with Enclosure		5 kg	18 kg	350 x 350 x 1090 mm	130
ITS02L ITS Series Tablet Stand with Enclosure		5 kg	18 kg	350 x 350 x 1090 mm	130
ITS04 ITS Series Tablet Stand with Enclosure		3 kg	10 kg	300 x 300 x 850 mm	130
ITS03 ITS Series Tablet Stand with Enclosure		8 kg	24 kg	400 x 525 x 1140 mm	131
ITS03L ITS Series Tablet Stand with Enclosure		8 kg	24 kg	400 x 525 x 1140 mm	131
ITS03P ITS Series Tablet Stand with Enclosure		8 kg	24 kg	400 x 525 x 1140 mm	131
ITS07 Indoor Tablet Kiosk		10 kg	14 kg	250 x 300 x 1220 mm	132
ITS08 Indoor Tablet Kiosk		10 kg	12 kg	350 x 350 x 1050 mm	132

► Mounts

Product	Image	Max. capacity	Weight	Dimensions (HxWxD)	Page
TDM01 Tablet Mount		3 kg	3 kg	115 x115 x 170 mm	133
TDM02 Tablet Mount		3 kg	4 kg	115 x115 x 170 mm	133

INFOKIOSKS AND ENCLOSURES



► Indoor Systems

Product	Image	Screen Size	Weight	Dimensions (HxWxD)	Page
IDS01 SERIES 19"-27" Indoor Kiosk		19"-27"	50 kg	1500 x 500 x 380 mm	136
IDS02 SERIES 19"-27" Indoor Touch Kiosk		19"-27"	50 kg	1340 x 500 x 380 mm	136







QUICK REFERENCE CHART

Product	Image	Screen Size	Weight	Dimensions (HxWxD)	Page
IDS03 SERIES 32"-42" Public Display Floor Stand		32"-42"	55 kg	1315 x 1000 x 600 mm	137
IDS04 SERIES 32"-65" Public Display Kiosk		32"-65"	130 kg	1992 x 780 x 400 mm	137
IDS05 SERIES 32"-65" Public Display Stand		32"-65"	70 kg	2011,5 x 950 x 218 mm	138
IDS06 SERIES 32"-65" Public Display Kiosk		32"-65"	75 kg	1980 x 950x 388,5 mm	138
IDS07 SERIES 42"-46" Public Display Stand		42"-46"	100 kg	2210 x 1235 x 295 mm	139
IDS010 SERIES 60"-70" Public Display Kiosk		60"-70"	250 kg	2200 x 1120 x 535 mm	139

► Outdoor Systems

Product	Image	Screen Size	Weight	Dimensions (HxWxD)	Page
ODS01 SERIES 19"-26" LCD Outdoor Display Stand		19"-26"	95 kg	1996 x 680 x 398 mm	140
ODS02 SERIES 40"-55" LCD Public Display Stand		40"-55"	70 kg	2210 x 1235 x 295 mm	140

► Screen Enclosures

Product	Image	Screen Size	Weight	Dimensions (HxWxD)	Page
IEN01 SERIES LCD/LED Indoor Enclosure		46"	60 kg	1200 x 840 x 183 mm	141
OEN01 SERIES LCD Enclosure		40"	55 kg	1110 x 720 x 180 mm	141
OEN02 SERIES Outdoor LCD Enclosure		46"	185 kg	1777 x 1680 x 260 mm	142
VX100 40"-65" Public Display Stand		40"-65"	110 kg	500 x 1100 x 2300 mm	142
VX200 40"-65" Public Display Stand		40"-65"	110 kg	500 x 930 x 2300 mm	143
VX300 40"-65" Public Display Stand		40"-65"	120 kg	600 x 1020 x 2325 mm	143
VX400 40"-47" Public Display Stand		40"-47"	100 kg	600 x 1150 x 1400 mm	144



PROJECTOR MOUNTS

FEATURES

3 step installation – easy assembly and connection in just 3 steps

Adjustment – flexible mounting pattern adjustment for all projector models

Height adjustable – variable height adjustment via telescopic pole

Cable management – integrated cable management for clean easy installation



Universal Projector Ceiling Mount (3 fixing points)

PM1

FEATURES

- Universal for all key projectors with multiple fixing points
- Telescopic mount including full height adjustment
- Professional micro adjustment ensures precise installation
- 360° full Horizontal adjustment
- Max weight capacity 15 kg

TECHNICAL



18°/18°



90°/90°



15 kg



min.448 mm
max.656mm



CEILING

PRODUCT SPECIFICATION

Dimensions	Weight	Max capacity	Colour	Packaging dimensions	EAN
656x450x450 mm	3 kg	15 kg	black silver white	550x240x85 mm	5908252960422 5908252960439 5908252962334



Universal Projector Ceiling Mount (4 fixing points)

PM2

CEILING



FEATURES

- Universal for all key projectors with multiple fixing points
- Telescopic mount including full height adjustment
- Professional micro adjustment ensures precise installation
- 360° full Horizontal adjustment
- Max weight capacity 15 kg

TECHNICAL



18°/18°



90°/90°



15 kg



min.448 mm
max.656mm

PRODUCT SPECIFICATION

Dimensions	Weight	Max capacity	Colour	Packaging dimensions	EAN
656x480x480 mm	3,3 kg	15 kg	black silver white	550x240x80 mm	5908252960446 5908252960453 5908252962211



CEILING



FEATURES

- Universal for all key projectors with multiple fixing points
- Telescopic mount including full height adjustment
- Professional micro adjustment ensures precise installation
- 360° full Horizontal adjustment
- Max weight capacity 15 kg

TECHNICAL



18°/18°



90°/90°



15 kg



min.250 mm
max.300mm

PRODUCT SPECIFICATION

Dimensions	Weight	Max capacity	Colour	Packaging dimensions	EAN
300x420x420 mm	2,6 kg	15 kg	black silver white	185x185x290 mm	5908252961580 5908252961597 5908252962228



FEATURES

- Universal for all key projectors with multiple fixing points
- Distance from the wall to projector 800 mm to 1293 mm
- Internal Cable management in pole
- Professional micro adjustment ensures precise installation
- 360° full Horizontal adjustment

TECHNICAL



10°/10°



-15,5°/+10



15 kg



min.800 mm
max.1293 mm

CEILING



PRODUCT SPECIFICATION

Dimensions	Weight	Max capacity	Colour	Packaging dimensions	EAN
1293x93x545 mm	5,6 kg	15kg	black silver	900x300x200 mm	5908252963331 5908252963348



FEATURES

- Universal for all key projectors with multiple fixing points
- Distance from the wall to projector 800 mm to 1293 mm
- Internal Cable management in pole
- Professional micro adjustment ensures precise installation
- 360° full Horizontal adjustment

PRODUCT SPECIFICATION

	Weight	Max capacity	Extension	Colour	Packaging dimensions	EAN
PM8	3,5 kg	20 kg	650-1100 mm	black silver white	670x240x80 mm	5908252968824 5908252962174 5908252962242
PM8.1	3,0 kg	20 kg	450-650 mm	black silver white	670x240x80 mm	5908252968824 5908252962174 5908252962242
PM8.2	5,3 kg	20 kg	1100-1950 mm	black silver white	670x240x80 mm	5908252968824 5908252962174 5908252962242

TECHNICAL



0°/90°



7,5°/7,5°



15 kg



650-1100 mm



CEILING



TECHNICAL



15 kg

PRODUCT SPECIFICATION

Dimensions	Weight	Max capacity	Colour	Packaging dimensions	EAN
420x380x230 mm	8 kg	15 kg	black silver white	430x390x240 mm	5908252963584 5908252963591 5908252963607



FEATURES

- Universal for all key projectors
- Adjustable tilt angle from 5° to 15°
- Height adjustment from 832 mm to 1217 mm
- Professional industrial casters with brake mechanism

TECHNICAL



360



5°/15°



15 kg



832/1217

CEILING



PRODUCT SPECIFICATION

Dimensions	Weight	Max capacity	Colour	Packaging dimensions	EAN
1217x690x690 mm	11 kg	15 kg	black silver	1060x640x220 mm	5908252962631 5908252962648

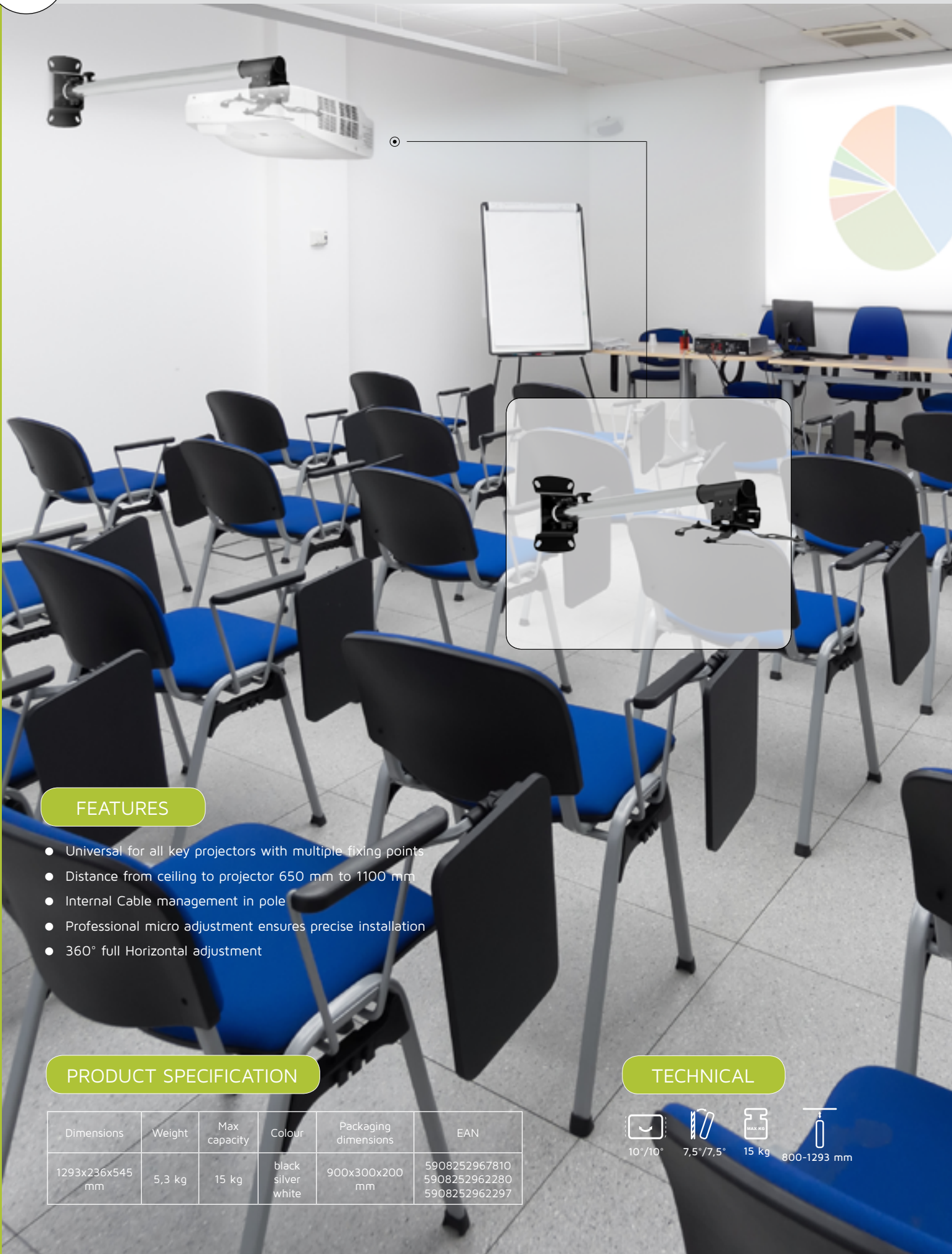

FEATURES

- Universal for all key projectors with multiple fixing points
- Distance from ceiling to projector 650 mm to 1100 mm
- Internal Cable management in pole
- Professional micro adjustment ensures precise installation
- 360° full Horizontal adjustment

PRODUCT SPECIFICATION

Dimensions	Weight	Max capacity	Colour	Packaging dimensions	EAN
1293x236x545 mm	5,3 kg	15 kg	black silver white	900x300x200 mm	5908252967810 5908252962280 5908252962297

TECHNICAL

10°/10° 7,5°/7,5° 15 kg 800-1293 mm



PMA1 I-beam mount for projectors



Colour	Packageing dimensions	EAN
black silver	420x170x140 mm	5908252963157 5908252963164

PMALK100 Safety padlock



Colour	Packageing dimensions	EAN
silver	150x50x30 mm	5908252964499

PMARM100 Decorative finishing ring for projectors



Colour	Packageing dimensions	EAN
black silver white	150x50x30 mm	5908252964161 5908252964178 5908252964185

PMAFP100 1 metre fixed length pole



Colour	Packageing dimensions	EAN
inox	1050x60x60 mm	5908252964260





TROLLEYS AND STANDS

FEATURES

Universal – Vesa mount and adapters included ensuring total screen compatibility

Adjustable – full Height and Tilt adjustment for mobility and varying requirements

Reliability – Professional casters with brake mechanism for security and safety

Flexibility – range of options from 1 to 4 screens for total mounting solution







32" - 47" Screen Stand

STD02

FEATURES

- Universal range of Vesa mounts and adapter included
- Heavy stable base with optional mounting direct to floor
- Full Internal Cable management
- Max weight capacity 60 kg

TECHNICAL

min.
100x100 mm
max.
500x400 mm

32"-47"

1703 mm

600x400 mm

30 kg



STANDS

PRODUCT SPECIFICATION

Dimensions	Weight	Max capacity	Colour	Packaging dimensions	EAN
1703x640x238 mm	30 kg	60 kg	black grey	1700x450x350 mm	5908252962068 5908252962143



19" - 32" LCD Stand

STD03





STANDS



FEATURES

- Universal range of Vesa mounts and adapter included
- Adjustable tilt angle from 0° to 45°
- Heavy stable base with optional mounting direct to floor
- Full Internal Cable management
- Tubular chrome pole luxury finish

TECHNICAL

min.
75x75 mm
max.
100x100 mm

19"-32"

0°/45°

75x75 mm
max.
100x100 mm

10 kg

PRODUCT SPECIFICATION

Dimensions	Weight	Max capacity	Colour	Packageing dimensions	EAN
1047x250x250 mm	15 kg	15 kg	black grey	1250x360x140 mm	5908252963065 5908252962310

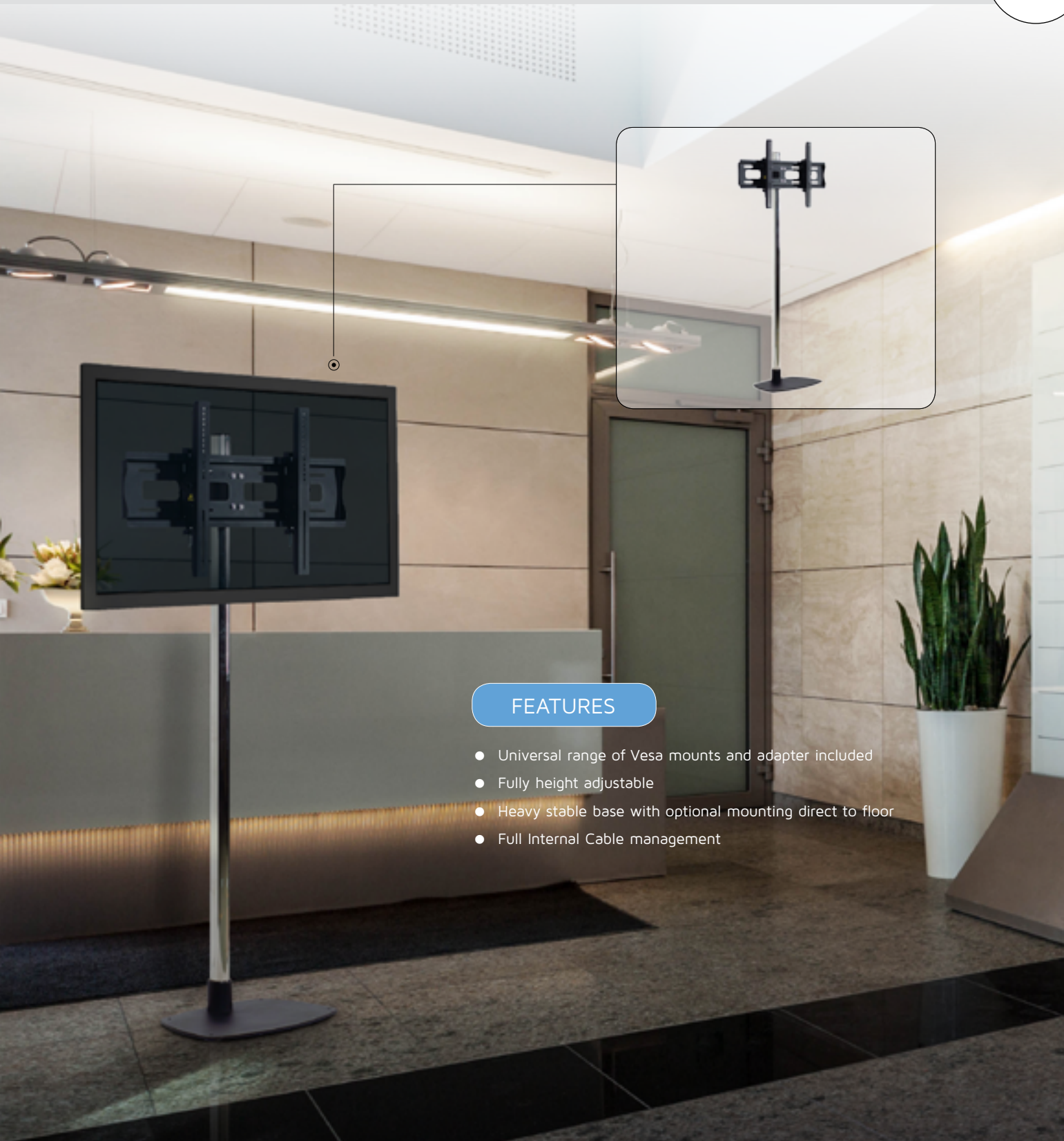
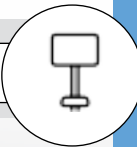

FEATURES

- Universal range of Vesa mounts and adapter included
- Fully height adjustable
- Heavy stable base with optional mounting direct to floor
- Full Internal Cable management

PRODUCT SPECIFICATION

Dimensions	Weight	Max capacity	Colour	Packaging dimensions	EAN
1700x800x350 mm	25 kg	80 kg	black grey	1800x360x140 mm	5908252962068 5908252962143

TECHNICAL



min.
75x75
max.
600x400
mm



32"-55"



min.
310 mm
max.
1700 mm



min.
50x95 mm
max.
750x460 mm



80 kg



FEATURES

- Universal range of Vesa mounts and adapter included
- Adjustable tilt angle from 0° to 45°
- Heavy stable base with optional mounting direct to floor
- Full Internal Cable management
- Tubular chrome pole luxury finish



PRODUCT SPECIFICATION

Dimensions	Weight	Max capacity	Colour	Packaging dimensions	EAN
1048,5x559x350 mm	22 kg	15 kg	black grey	1150x360x140 mm	5908252963072 5908252963089

TECHNICAL



min.
75x75
max.
100x100
mm



19"-32"



0°/45°



min.
75x75 mm
max.
100x100 mm



10 kg



STANDS



FEATURES

- Universal range of Vesa mounts and adapter included
- Fully height adjustable
- Adjustable tilt angle from 120°
- 360° rotation for portrait or horizontal screen option
- Easy position adjustment

TECHNICAL

min. 75x75 mm
max. 100x100 mm

19"-27"

1650mm

min. 75x75 mm
max. 100x100 mm

10 kg

120°

360°

PRODUCT SPECIFICATION

Dimensions	Weight	Max capacity	Colour	Packaging dimensions	EAN
1650x664x545 mm	15 kg	10 kg	black grey	1670x675x555 mm	5908252960767 5908252960774



FEATURES

- Universal range of Vesa mounts and adapter included
- Adjustable tilt angle from -6° to 9°
- Fully height adjustable
- Full Internal Cable management
- Professional industrial casters with brake mechanism
- Tubular chrome pole luxury finish

TECHNICAL

min. 75x75 mm
max. 600x400 mm

40"-70"

min. 300 mm
max. 1700 mm

min. 50x95 mm
max. 750x460 mm

80 kg

-6°/+9°

-3,3° / +3,3°

STANDS



PRODUCT SPECIFICATION

Dimensions	Weight	Max capacity	Colour	Packaging dimensions	EAN
1810x1127x694 mm	46 kg	80 kg	black grey	1800x730x140 mm	5908252960118 5908252960125



32"-47" Screen Stand

STD15

FEATURES

- Universal range of Vesa mounts and adapter included
- Heavy stable base
- Full Internal Cable management
- Tubular chrome pole luxury finish
- Max weight capacity 30 kg

TECHNICAL



min.
300x300 mm
max.
600x400 mm



32"-47"



1200 mm



30 kg



STANDS

PRODUCT SPECIFICATION

Dimensions	Weight	Max capacity	Colour	Packaging dimensions	EAN
1200x720x480 mm	18,5 kg	30 kg	black grey	1200x550x150 mm	5908252965915 5908252965922



32"-47" Screen Stand

STD16

STANDS



FEATURES

- Universal range of Vesa mounts and adapter included
- Fully height adjustable
- Adjustable tilt angle from -6° to 9°
- Heavy stable base
- Full Internal Cable management

TECHNICAL



min.
75x75 mm
max.
600x400 mm



32"-47"



1880 mm



-6,5°/12°



30 kg

PRODUCT SPECIFICATION

Dimensions	Weight	Max capacity	Colour	Packaging dimensions	EAN
1720x800x570 mm	25 kg	30 kg	black grey	1800x360x140 mm	5908252965939 5908252965946



FEATURES

- Universal range of Vesa mounts and adapter included
- Adjustable tilt angle from -6° to 9°
- Fully height adjustable
- Full Internal Cable management
- Professional industrial casters with brake mechanism
- Tubular chrome pole luxury finish

PRODUCT SPECIFICATION

Dimensions	Weight	Max capacity	Colour	Packaging dimensions	EAN
1810x1144x690 mm	40 kg	80 kg	black grey	1800x730x140 mm	5908252961412 5908252961429

TECHNICAL

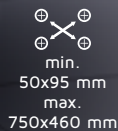
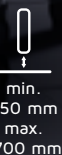



42"-70" Flat Screen AV Trolley

TR2

FEATURES

- Universal range of Vesa mounts and adapter included
- Adjustable tilt angle from -6° to 9°
- Fully height adjustable
- Full Internal Cable management
- Professional industrial casters with brake mechanism
- Tubular chrome pole luxury finish

TECHNICAL



min.
75x75 mm
max.
600x400 mm



42"-70"



min.
300 mm
max.
1700 mm



min.
50x95 mm
max.
750x460 mm



80 kg



-6°/+9°



-3,3° / +3,3°



TROLLEYS

PRODUCT SPECIFICATION

Dimensions	Weight	Max capacity	Colour	Packaging dimensions	EAN
1810x1070x500 mm	58 kg	80 kg	black grey	1800x500x140 mm	5908252960781 5908252960798



37"-60" Flat Screen AV Trolley

TR4

FEATURES

- Universal range of Vesa mounts and adapter included
- Adjustable tilt angle from -6° to 9°
- Fully height adjustable
- Full Internal Cable management
- Professional industrial casters with brake mechanism
- Tubular chrome pole luxury finish

TECHNICAL



min.
75x75 mm
max.
600x400 mm



37"-60"



min.
300 mm
max.
1700 mm



min.
50x95 mm
max.
750x460 mm



80 kg



-6°/+9°



-3,3° / +3,3°

TROLLEYS



PRODUCT SPECIFICATION

Dimensions	Weight	Max capacity	Colour	Packaging dimensions	EAN
1700x1000x500 mm	45 kg	80 kg	black grey	1800x550x140 mm	5908252961399 5908252961405



TROLLEYS



FEATURES

- Universal range of Vesa mounts and adapter included
- Adjustable tilt angle from -6° to 9°
- Fully height adjustable
- Full Internal Cable management
- Professional industrial casters with brake mechanism
- Tubular chrome pole luxury finish

TECHNICAL

min. 75x75 mm
max. 600x400 mm

37"-60"

min. 250 mm
max. 1700 mm

min. 50x95 mm
max. 750x460 mm

80 kg

-6°/+9° -3,3° / +3,3°

PRODUCT SPECIFICATION

Dimensions	Weight	Max capacity	Colour	Packaging dimensions	EAN
1700x1140x703 mm	24,4 kg	80 kg	black silver	1800x730x140 mm	5908252965748 5908252965755



FEATURES

- Universal range of Vesa mounts and adapter included
- Full Internal Cable management
- Professional industrial casters with brake mechanism
- Additional mounting shelf included
- Tubular chrome pole luxury finish
- Max weight capacity 80 kg

TECHNICAL

min. 75x75 mm
max. 600x400 mm

37"-60"

1606 mm

min. 50x95 mm
max. 750x460 mm

80 kg

TROLLEYS



PRODUCT SPECIFICATION

Dimensions	Weight	Max capacity	Colour	Packaging dimensions	EAN
1606x897x536 mm	65 kg	80 kg	black grey	1150x360x140 mm	5908252962273 5908252962518



37"-60" Low Level Flat Screen Trolley

TR8

FEATURES

- Universal range of Vesa mounts and adapter included
- Adjustable tilt angle from 0° to 28°
- Full Internal Cable management
- Tubular chrome pole luxury finish
- Professional industrial casters with brake mechanism
- Max weight capacity 80 kg

TECHNICAL



min.
75x75 mm
max.
600x400 mm



37"-60"



1606 mm



min.
50x95 mm
max.
750x460 mm



80 kg



TROLLEYS

PRODUCT SPECIFICATION

Dimensions	Weight	Max capacity	Colour	Packaging dimensions	EAN
1006x1070x500 mm	45 kg	80 kg	black grey	1800x730x180 mm	5908252962525 5908252962532



37"-60" Flat Screen AV Trolley

TR9

TROLLEYS



FEATURES

- Universal range of Vesa mounts and adapter included
- Full Internal Cable management
- Professional industrial casters with brake mechanism
- Additional mounting shelf included
- Tubular chrome pole luxury finish
- Max weight capacity 50 kg

TECHNICAL



min.
100x100 mm
max.
600x400 mm



37"-60"



min.
895 mm
max.
1710 mm



min.
70x95 mm
max.
740x460 mm



50 kg

PRODUCT SPECIFICATION

Dimensions	Weight	Max capacity	Colour	Packaging dimensions	EAN
1784x600x640 mm	45 kg	50 kg	black grey	1800x730x180 mm	5908252963300 5908252963874

-6,5° / +12°



TROLLEYS



FEATURES

- Universal range of Vesa mounts and adapter included
- Full Internal Cable management
- Professional industrial casters with brake mechanism
- Additional mounting shelf included
- Tubular chrome pole luxury finish
- Max weight capacity 50 kg

TECHNICAL

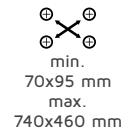
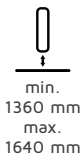

PRODUCT SPECIFICATION

Dimensions	Weight	Max capacity	Colour	Packaging dimensions	EAN
1780x1023x767 mm	55 kg	50 kg	black grey	1000x550x180 mm	5908252963775 5908252963782



FEATURES

- Universal range of Vesa mounts and adapter included
- Telescopic height adjustment from 1275 mm to 1775 mm
- Professional industrial casters with brake mechanism
- Adjustable tilt angle from -6,5° to 12°
- Max weight capacity 50 kg

TECHNICAL

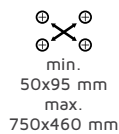
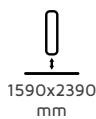

PRODUCT SPECIFICATION

Dimensions	Weight	Max capacity	Colour	Packaging dimensions	EAN
2390x1127x694 mm	22,3 kg	50 kg	black silver	1800x730x140 mm	5908252968312 5908252967995

TROLLEYS





60"-95" Flat Screen AV Trolley

TR18

FEATURES

- Universal range of Vesa mounts and adapter included
- Full Internal Cable management
- Fully height adjustable
- Professional industrial casters with brake mechanism
- Tubular chrome pole luxury finish
- Max weight capacity 80 kg

TECHNICAL



min.
75x75 mm
max.
800x400 mm



60"-95"



1700 mm



min.
50x75 mm
max.
850x460 mm



80 kg



TROLLEYS

PRODUCT SPECIFICATION

Dimensions	Weight	Max capacity	Colour	Packaging dimensions	EAN
1869x1705x815 mm	55,6 kg	80 kg	black silver	1800x730x140 mm	5908252968701 5908252969975



37"-60" Dual Flat Screen AV Trolley

TR12

TROLLEYS



FEATURES

- Universal range of Vesa mounts and adapter included
- Full Internal Cable management
- Professional industrial casters with brake mechanism
- Tubular chrome pole luxury finish
- Max weight capacity 50 kg

TECHNICAL



min.
75x75 mm
max.
800x400 mm



37"-60"



1950 mm



min.
70x95 mm
max.
740x460 mm



100 kg

PRODUCT SPECIFICATION

Dimensions	Weight	Max capacity	Colour	Packaging dimensions	EAN
2083x1116x802 mm	50 kg	100 kg	black grey	1200x600x140 mm	5908252960118 5908252963881



TROLLEYS



FEATURES

- Universal range of Vesa mounts and adapter included
- Flexible option of mounting 2 screens
- Adjustable tilt angle from -6° to 9°
- Fully height adjustable
- Full Internal Cable management
- Professional industrial casters with brake mechanism

TECHNICAL

 min. 75x75 mm max. 600x400 mm

 37"-60"

 min. 200 mm max. 2000 mm

 min. 50x95 mm max. 750x460 mm

 80 kg

 -6°/+9°

 -3,3° / +3,3°

PRODUCT SPECIFICATION

Dimensions	Weight	Max capacity	Colour	Packaging dimensions	EAN
2083x1116x802 mm	50 kg	100 kg	black grey	1200x600x140 mm	5908252960118 5908252963881



FEATURES

- Universal range of Vesa mounts and adapter included
- Flexible option of mounting 2 screens
- Fully height adjustable
- Full Internal Cable management
- Professional industrial casters with brake mechanism
- Tubular chrome pole luxury finish

TECHNICAL

 min. 100x100 mm max. 600x400 mm

 40"-47"

 min. 300 mm max. 1600 mm

 min. 50x95 mm max. 750x460 mm

 80 kg

TROLLEYS



PRODUCT SPECIFICATION

Dimensions	Weight	Max capacity	Colour	Packaging dimensions	EAN
1850x1800x815 mm	61,3 kg	80 kg	black silver	1800x730x140 mm	5908252968329 5908252968046



50"-60" Dual Flat Screen AV Trolley

TR20

FEATURES

- Universal range of Vesa mounts and adapter included
- Flexible option of mounting 2 screens
- Fully height adjustable
- Full Internal Cable management
- Professional industrial casters with brake mechanism
- Max weight capacity 80 kg

TECHNICAL



min.
75x75 mm
max.
600x400 mm



50"-60"



min.
300 mm
max.
1700 mm



min.
50x75 mm
max.
850x460 mm



80 kg



TROLLEYS

PRODUCT SPECIFICATION

Dimensions	Weight	Max capacity	Colour	Packaging dimensions	EAN
1847x2200x815 mm	67,5 kg	80 kg	black silver	1800x730x140 mm	5908252968695 5908252968787



32"-37" Dual Flat Screen AV Trolley

TR21

TROLLEYS



FEATURES

- Universal range of Vesa mounts and adapter included
- Flexible option of mounting 2 screens
- Fully height adjustable
- Full Internal Cable management
- Professional industrial casters with brake mechanism
- Max weight capacity 80 kg

TECHNICAL



min.
75x75 mm
max.
600x400 mm



32"-37"



min.
300 mm
max.
1700 mm



min.
50x95 mm
max.
750x460 mm



80 kg

PRODUCT SPECIFICATION

Dimensions	Weight	Max capacity	Colour	Packaging dimensions	EAN
1805x1127x694 mm	50 kg	80 kg	black silver	1800x730x140 mm	5908252968633 5908252968817



TROLLEYS



FEATURES

- Universal range of Vesa mounts and adapter included
- Flexible option of mounting 2 screens
- Fully height adjustable
- Full Internal Cable management
- Professional industrial casters with brake mechanism
- Max weight capacity 120 kg

TECHNICAL



min. 75x75 mm
max. 600x400 mm



37"-55"



min. 520 mm
max. 1700 mm



min. 50x95 mm
max. 750x460 mm



120 kg

PRODUCT SPECIFICATION

Dimensions	Weight	Max capacity	Colour	Packaging dimensions	EAN
1830x360x140 mm	118,5 kg	120 kg	black grey	1800x360x140 mm	5908252962440 5908252962471



FEATURES

- Universal range of Vesa mounts and adapter included
- Flexible option of mounting 4 screens
- Fully height adjustable
- Full Internal Cable management
- Professional industrial casters with brake mechanism
- Max weight capacity 120 kg

TECHNICAL



min. 75x75 mm
max. 600x400 mm



37"-55"



min. 520 mm
max. 1700 mm



min. 50x95 mm
max. 750x460 mm



120 kg

TROLLEYS



PRODUCT SPECIFICATION

Dimensions	Weight	Max capacity	Colour	Packaging dimensions	EAN
1830x1700x800 mm	130 kg	120 kg	black grey	1250x360x140mm	5908252962495 5908252962457



19"-27" Flat Screen AV Trolley

SV55

FEATURES

- Universal range of Vesa mounts and adapter included
- Additional mounting shelf included
- Fully height adjustable
- Adjustable tilt angle 250°
- 360° rotation for portrait or horizontal screen option
- Easy position adjustment

TECHNICAL

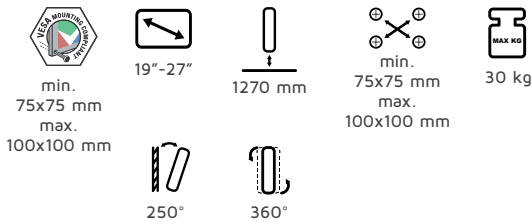

TROLLEYS

PRODUCT SPECIFICATION

Dimensions	Weight	Max capacity	Colour	Packaging dimensions	EAN
1270x690x690 mm	13 kg	10 kg	black silver	1060x620x220 mm	5908252963317 5908252963324



19"-27" Universal Adjustable Trolley with PC Mount

SV53

TROLLEYS



FEATURES

- Universal range of Vesa mounts and adapter included
- Additional mounting shelf included
- Fully height adjustable
- Adjustable tilt angle 250°
- 360° rotation for portrait or horizontal screen option
- Easy position adjustment

TECHNICAL

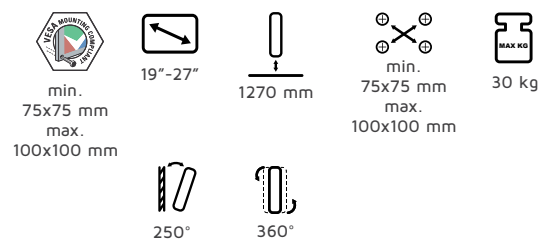

PRODUCT SPECIFICATION

Dimensions	Weight	Max capacity	Colour	Packaging dimensions	EAN
1270x690x690 mm	18 kg	10 kg	black silver	1060x620x220 mm	5908252961832 5908252961269

40"-55" Trolley for screen

ETR1



ELECTRIC HEIGHT ADJUSTABLE TROLLEYS



FEATURES

- Fully electrical height adjustable from 1030 mm to 1850 mm
- Universal range of Vesa mounts and adapter included
- Adjustable tilt angle from 6,5° to 12°
- Professional industrial casters with brake mechanism

TECHNICAL

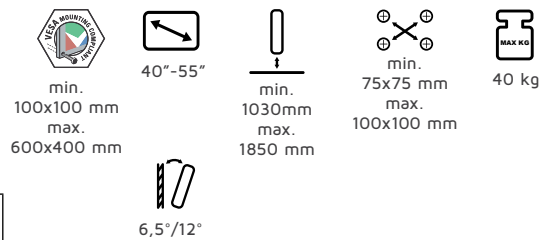

PRODUCT SPECIFICATION

Dimensions	Weight	Max capacity	Colour	Packaging dimensions	EAN
1270x690x690 mm	18 kg	10 kg	black silver	1060x620x220 mm	5908252961832 5908252961269

40"-55" Trolley for screen

ETR2



FEATURES

- Fully electrical height adjustable from 1030 mm to 1850 mm
- Universal range of Vesa mounts and adapter included
- Adjustable tilt angle from 6,5° to 12°
- Professional industrial casters with brake mechanism

TECHNICAL

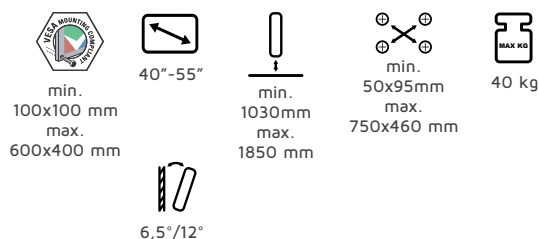

PRODUCT SPECIFICATION

Dimensions	Weight	Max capacity	Colour	Packaging dimensions	EAN
1835x1144x770 mm	37,4 kg	40 kg	black	1200x800x1000 mm	5908252968336

ELECTRIC HEIGHT ADJUSTABLE TROLLEYS



ETR Series Electric height adjustment trolley

FEATURES

- Fully electrical height adjustable
- Universal range of Vesa mounts and adapter included
- Adjustable tilt angle from 0° to 90°
- Professional industrial casters with brakemechansim

FEATURES PHOTO



ELECTRIC HEIGHT ADJUSTABLE TROLLEYS



PRODUCT	SCREEN SIZE	MAX. CAPACITY	VESA	WEIGHT	DIMENSIONS	EAN
ETR3	40-55"	60 kg	min. 100x100 max. 600x400	45 kg	1200x900x750 mm	5908252965083
ETR4	50-55"	80 kg	min. 200x100 max. 600x400	45 kg	1450x900x750 mm	5908252965410



ETRE Series Electric height adjustment trolley

ELECTRIC HEIGHT ADJUSTABLE TROLLEYS



FEATURES

- Fully electrical height adjustable
- Universal range of Vesa mounts and adapter included
- Adjustable tilt angle from 0° to 90°
- Professional industrial casters with brake mechansim

FEATURES PHOTO

PRODUCT	SCREEN SIZE	MAX. CAPACITY	VESA	WEIGHT	DIMENSIONS	EAN
ETRE3	40-55"	40 kg	min. 100x100 max. 400x200	60 kg	1200x900x750 mm	5908252962396
ETRE4	60-90"	40 kg	min. 100x100 max. 800x400	80 kg	1382x1500x723 mm	5908252962594





VIDEOCONFERENCING



FEATURES

- Universal range of Vesa mounts and adapter included
- Supporting heavy displays up to 80 kg
- Fully height adjustable
- Includes storage space for PC and VC equipment
- Full Internal Cable management

TECHNICAL



min.
100x100 mm
max.
600x400 mm



65"-95"



min.
1030mm
max.
1850 mm



min.
50x95mm
max.
750x460 mm



80 kg

PRODUCT SPECIFICATION

Dimensions	Weight	Max capacity	Colour	Packaging dimensions	EAN
1845x1705x878 mm	84,6 kg	80 kg	black silver	1800x730x800 mm	5908252968305 5908252967896

Video Conferencing Trolley for Dual Screens with motorised height adjustment



FEATURES

- Fully electrical height adjustable
- Universal range of Vesa mounts and adapter included
- Adjustable tilt angle from 0° to 90°
- Professional industrial casters with brake mechanism

FEATURES PHOTO



VIDEOCONFERENCING

PRODUCT	SCREEN SIZE	MAX. CAPACITY	VESA	WEIGHT	DIMENSIONS	EAN
EVCT247	40-47"	80 kg	min. 100x100 max. 600x400	97 kg	987x1718x564 mm	5908252966165
EVCT255	50-55"	80 kg	min. 200x100 max. 600x400	100 kg	1900x1718x566 mm	5908252963744



EVCT Series Video Conferencing Trolleys with motorised height adjustment



FEATURES

- Fully electrical height adjustable
- Universal range of Vesa mounts and adapter included
- Includes storage space for PC and VC equipment
- Professional casters with brake mechanism
- Additional camera shelf included



PRODUCT SPECIFICATION

PRODUCT	SCREEN SIZE	MAX. CAPACITY	VESA	WEIGHT	DIMENSIONS	EAN
EVCT155	42-55"	80 kg	min. 100x100 mm max. 600x400 mm	97 kg	987x1718x564 mm	5908252962617 5908252962624
EVCT170	60-70"	80 kg	min. 100x100 mm max. 800x400 mm	97 kg	1139x782x723 mm	5908252962662 5908252962723
EVCT190	79-90"	80 kg	min. 100x100 mm max. 800x400 mm	100 kg	1100x1718x566 mm	5908252963737



VIDEOCONFERENCING



FEATURES

- Universal range of Vesa mounts and adapter included
- Flexible option of mounting 2 screens
- Includes storage space for PC and VC equipment
- Fully height adjustable
- Full Internal Cable management

TECHNICAL



min.
75x75 mm
max.
600x400 mm



32"-37"



min.
1590mm
max.
2390 mm



min.
50x95 mm
max.
750x460 mm



50 kg

PRODUCT SPECIFICATION

Dimensions	Weight	Max capacity	Colour	Packaging dimensions	EAN
1805x1127x694 mm	50 kg	80 kg	black silver	1800x730x140 mm	5908252968633 5908252968817



FEATURES

- Universal range of Vesa mounts and adapter included
- Flexible option of mounting 2 screens
- Includes storage space for PC and VC equipment
- Fully height adjustable
- Full Internal Cable management

FEATURES PHOTO



VIDEOCONFERENCING



PRODUCT	SCREEN SIZE	MAX. CAPACITY	VESA	WEIGHT	DIMENSIONS	EAN
VCTR247	40-47"	80 kg	min. 100x100 max. 600x400	93,4 kg	50x1705x878 mm	5908252968878
VCTR260	50-60"	80 kg	min. 75x75 max. 600x400	93 kg	1847x2200x815 mm	5908252968828



Mega trolley

FEATURES

- Universal range of Vesa mounts and adapter included
- Supporting heavy displays up to 120 kg
- Fully height adjustable
- Includes storage space for PC and VC equipment
- Full Internal Cable management

FEATURES PHOTO



PRODUCT	SCREEN SIZE	MAX. CAPACITY	VESA	WEIGHT	DIMENSIONS	EAN
MTR100	65-70"	120 kg	min. 100x100 max. 600x400	100 kg	1520x860x700 mm	5908252966035
MTR101	80-85"	120 kg	min. 100x100 max. 800x400	110 kg	1700x1110x870 mm	5908252966059



VIDEOCONFERENCING



Video Conferencing Trolley for Dual Screens with height adjustment

NEW PRODUCT



FEATURES

- Fully height adjustable
- Universal range of Vesa mounts and adapter included
- Adjustable tilt angle from 0° to 90°
- Professional industrial casters with brake mechanism

FEATURES PHOTO

PRODUCT	SCREEN SIZE	MAX. CAPACITY	VESA	WEIGHT	DIMENSIONS	EAN
VCTX247	40-47"	80 kg	min. 100x100 max. 600x400	97 kg	1900x1958x873 mm	5908252969173
VCTX255	50-55"	80 kg	min. 200x100 max. 600x400	100 kg	1900x1958x873 mm	5908252969166

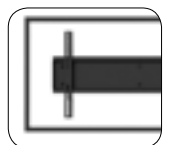

VIDEO CONFERENCING

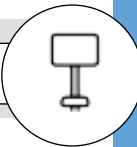

FEATURES

- Fully height adjustable
- Universal range of Vesa mounts and adapter included
- Includes storage space for PC and VC equipment
- Professional casters with brake mechanism
- Additional camera shelf included

FEATURES PHOTO

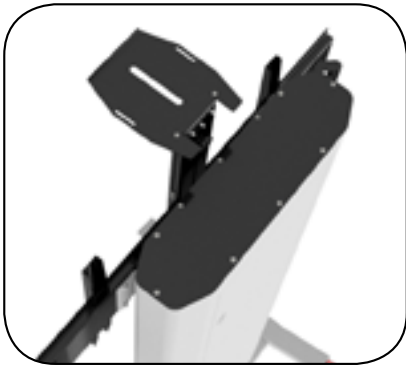
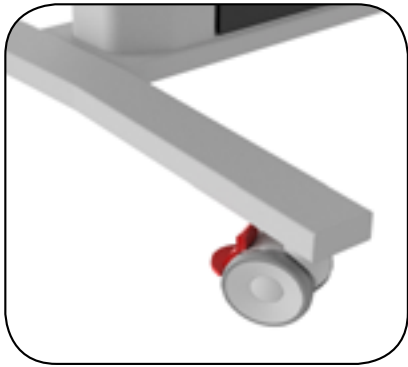

PRODUCT	SCREEN SIZE	MAX. CAPACITY	VESA	WEIGHT	DIMENSIONS	EAN
VCTX155	42-55"	80 kg	min. 100x100 max. 600x400	97 kg	1100X1958X873 mm	5908252969180
VCTX170	60-70"	80 kg	min. 100x100 max. 800x400	97 kg	1100X1958X873 mm	5908252969128
VCTX190	79-90"	80 kg	min. 100x100 max. 800x400	100 kg	1100X1958X873 mm	5908252969203



ACCESSORIES

CH1 Video Conferencing Camera Shelf for TR1/TR2/TR3 Trolley

Colour	Packaging dimensions	EAN
grey	550x250x150 mm	5908252962358



CH3 Video Conferencing Camera Holder for LWB, PWB, TWB

Colour	Packaging dimensions	EAN
grey	480x260x150 mm	5908252963416



CH4 Video Conferencing Camera Holder

Colour	Packaging dimensions	EAN
black silver	550x250x150 mm	5908252968190 5908252968042



CH5 Video Conferencing Camera Holder

Colour	Packaging dimensions	EAN
silver	550x250x150 mm	5908252962006



RH1 R1/2/3/6 rotating head

Colour	Packaging dimensions	EAN
black grey	650x520x120 mm	5908252962761 5908252962778



GD23 VESA Adapter for TR1/TR2/TR3 trolley

Colour	Packaging dimensions	EAN
black grey	160x225x20 mm	5908252961542 5908252961559



TRS1 Glass shelf for TR1/TR2/TR3 trolley

Colour	Packaging dimensions	EAN
black grey	650x520x120 mm	5908252960835 5908252960842



TRS2 Glass shelf with handle TR1/TR2/TR3 trolley

Colour	Packaging dimensions	EAN
black grey	650x520x120 mm	5908252960255 5908252960262



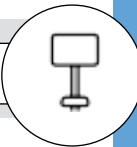

TRS4

Glass shelf with handle TR4/TR5/TR6 trolley

Colour	Packaging dimensions	EAN
black grey	650x250x120 mm	5908252960170 5908252961825

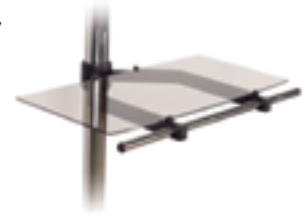

TRSM100

Metal shelf for TR4/TR5/TR6 trolley

Colour	Packaging dimensions	EAN
black silver inox	650x520x120 mm	5908252964307 5908252964314 5908252964321



TRSM200

Metal shelf for TR1/TR2/TR3 trolley

Colour	Packaging dimensions	EAN
black silver inox	650x520x120 mm	5908252964345 5908252964352 5908252964369



TRSM1

Metal shelf for TR14/TR18/TR20

Colour	Packaging dimensions	EAN
black	750x320x50 mm	5908252968244



TRSM2

Metal shelf for power strip

Colour	Packaging dimensions	EAN
black silver	265x127x215 mm	5908252968749 5908252967988



TRMS3

Metal shelf for mini PC

Colour	Packaging dimensions	EAN
black silver	380x95x50 mm	5908252967971 5908252967933



TRAD100

Metal shelf for documents

Colour	Packaging dimensions	EAN
black grey	650x520x120 mm	5908252964383 5908252964390



RF1 (4 pcs)

Rubber feet (4x)

Colour	Packaging dimensions	EAN
black	135x135x55 mm	5908252960804





ACCESSORIES

TRAC100/101 Computer case with lock (small)

Colour	Packaging dimensions	EAN
black silver	550x250x450 mm	5908252964505 5908252964581



TRAC200/201 Computer case with lock (medium)

Colour	Packaging dimensions	EAN
black silver	650x300x550 mm	5908252964512 5908252964598



TRAC300/301 Computer case with lock (large)

Colour	Packaging dimensions	EAN
black silver	650x300x550 mm	5908252964529 5908252964536



TRAC600 Internal storage for rack mountable components

Colour	Packaging dimensions	EAN
Black	650x550x650 mm	5908252968220



SP1 Splitted poles for trolleys TR1/TR2/TR3

Colour	Packaging dimensions	EAN
grey	1020x130x140 mm	5908252963102



SP2 Splitted pole for trolleys TR4/TR5

Colour	Packaging dimensions	EAN
grey	1020x130x70 mm	5908252963119



FC1 Flightcase

Colour	Packaging dimensions	EAN
black grey white	420x170x140 mm	5908252963157 5908252963164 5908252965946





VIDEO WALLS

FEATURES

Seamless adjustment – 8-point tool-less adjustment for precision installation

Universal - designed for all screens 42"-95" with precision dedicated spacer kit solution

Pop Out – simple effective push/pop-out design for fast extension and retraction

Serviceable – Full service access including prop-out supports for safety and convenience



The VWPOP65-L is purpose designed for easy and fast servicing of recessed multi-screen installations. The simple one touch „pop out“ mechanism allows full extension of the display out of the videowall so access and servicing can be performed quickly and safely. Tool-less micro-adjustment is included for seamless alignment of the displays and precision dedicated spacers eliminate requirement for on-site calculations and measurements.

FEATURES

- Tool-less independent 8-point micro-adjustment provides seamless alignment of the displays.
- Fast Release Pop-out mechanism provides convenient display access designed for used in enclosed or recessed installations.
- Pop-out mechanism can be temporarily removed with security locking screw to prevent unintentional pop-outs.
- Open Frame design allows full electrical wiring access and Integrated cable management strips make display-to-display cabling simple.
- Sequentially drilled wall plate and precision dedicated display spacers eliminate requirement for on-site calculations.
- Fast Release Pop-Out mechanism can be adjusted for varying display weights, ensuring safe and controlled extension.

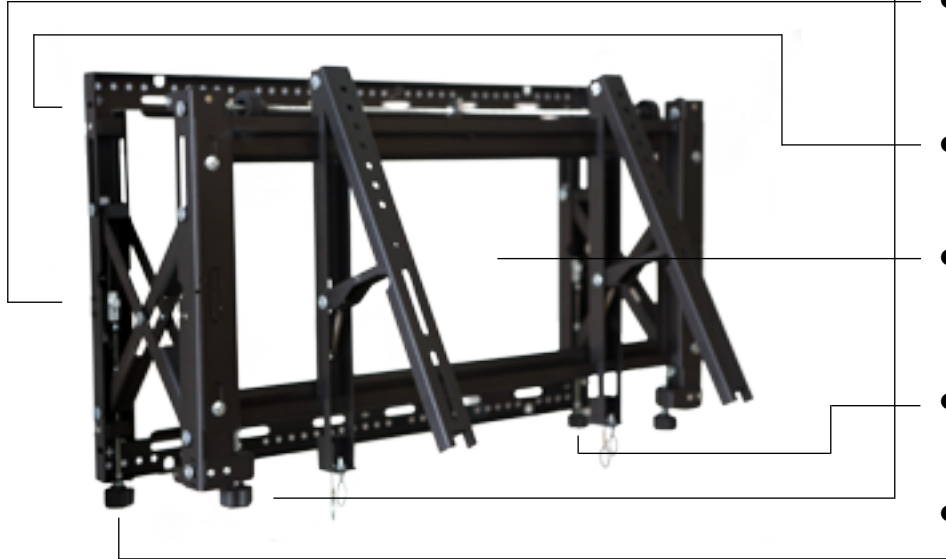

tool-less micro-adjustment



security padlock



dedicated spacers



FEATURES



min. 100x100 mm max. 600x400 mm



42"-65"



85-270 mm



0-28°



60 kg

ACCESSORIES

SPACERS



TECHNICAL

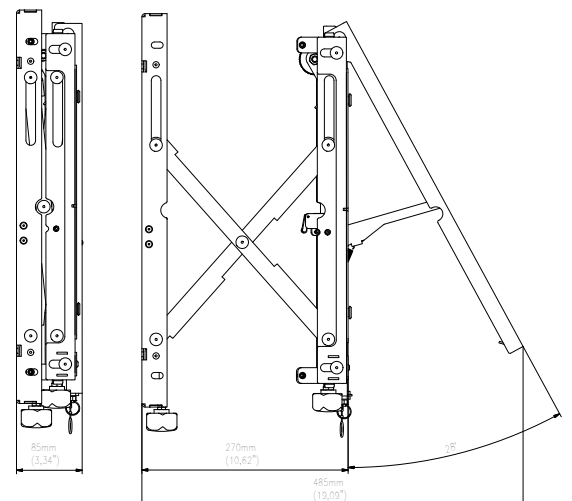
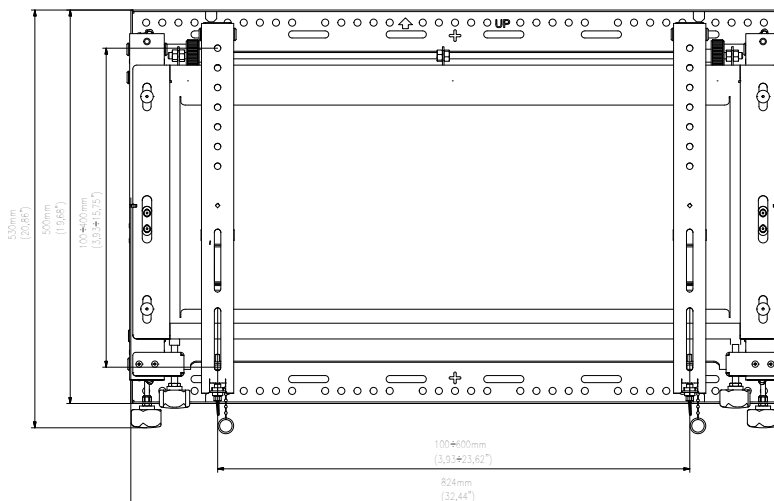

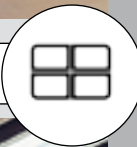

PRODUCT	SCREEN SIZE	MAX. CAPACITY	VESA	WEIGHT	DIMENSIONS	EAN
VWPOP65-L	42-65"	60 kg	400-600 mm	14 kg	824x530x80 mm	59008252968589
VWPOP85-L	70-85"	80 kg	600-400 mm	14 kg	850x530x80 mm	5908252968589
VWPOP95-L	70-95"	120 kg	800-600 mm	30 kg	1084x700x100 mm	5908252968176



VWFS Series - Full Service Universal Video Wall, Landscape

The VWFS Series is purpose designed for easy and fast servicing in video wall installations. The full service mechanism allows extension of the display out of the videowall so access and servicing can be performed quickly and safely. Tool-less micro-adjustment is included for seamless alignment of the displays and precision dedicated spacers eliminate requirement for on-site calculations and measurements.

FEATURES

- Security padlock for anti-theft deterrent ensures increased security in public areas.
- Mechanism extension includes upward tilt position with prop stands holding weight of display for easy and safe servicing.
- Open Frame design allows full electrical wiring access and Integrated cable management strips make display-to-display cabling simple
- Sequentially drilled wall plate and precision dedicated display spacers eliminate requirement for on-site calculations.
- Tool-less independent 8-point micro-adjustment provides seamless alignment of the displays.
- Pull-out/prop-open mechanism provides quick and easy access for servicing.

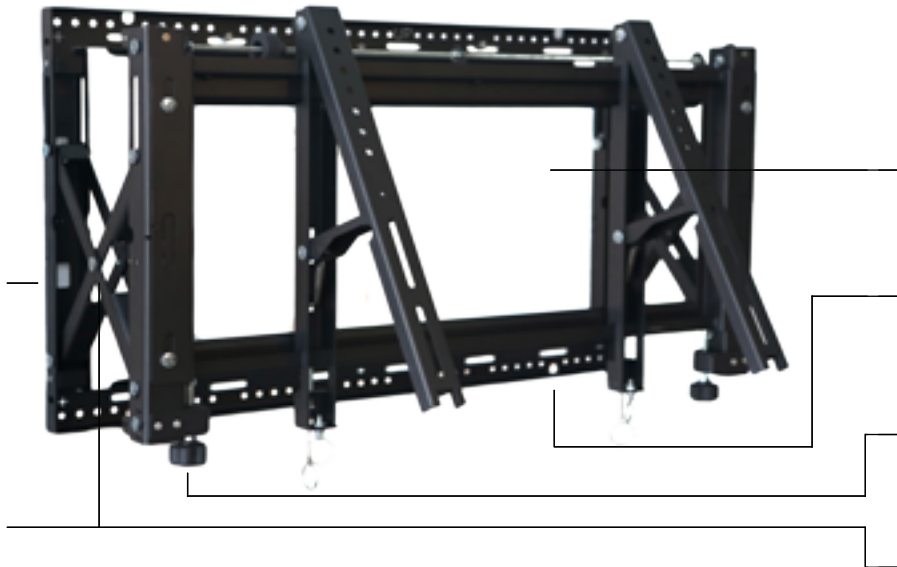

tool-less micro-adjustment



security padlock



full service access



ACCESSORIES

SPACERS



PRODUCT	SCREEN SIZE	MAX. CAPACITY	MAX. VESA	WEIGHT	DIMENSIONS	EAN
VWFS65-L	42-65"	60 kg	600-400 mm	13,5 kg	824x500x80 mm	5908252968572
VWFS85-L	70-85"	80 kg	600-400 mm	13,5 kg	824x500x80 mm	5908252966349
VWFS95-L	90-95"	130 kg	800-600 mm	26 kg	1070x670x100 mm	5908252968756

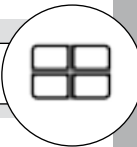

The VWFX is purpose designed for easy and fast installation in video wall installations and for forward tilting walls and menu board applications up to 45°. The VWFX65-L is designed for modular use with models VWPOP and VWFS or alternatively where full service access is not required. Tool-less micro-adjustment is included for seamless alignment of the displays and precision dedicated spacers eliminate requirement for on-site calculations and measurements.

FEATURES

- Security padlock for anti-theft deterrent ensures increased security in public areas.
- Designed for use in forward tilting walls and menu board applications up to 45°.
- Sequentially drilled wall plate and precision dedicated display spacers eliminate requirement for on-site calculations.
- Tool-less independent 8-point micro-adjustment provides seamless alignment of the displays.
- Adjustable VESA mounting patterns from 100 x 100 up to 600 x 400.
- Modular mount for unlimited video wall display configurations, can be used with models VWPOP and VWFS.

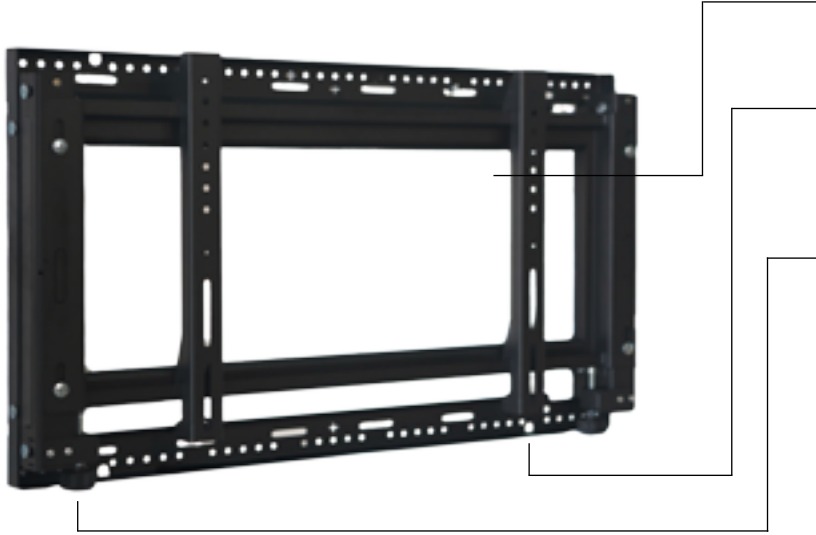

tool-less micro-adjustment



security padlock



dedicated spacers



ACCESSORIES

SPACERS



PRODUCT	SCREEN SIZE	MAX. CAPACITY	MAX. VESA	WEIGHT	DIMENSIONS	EAN
VWFX65-L	42-65"	60 kg	600-400 mm	11 kg	826x500x80 mm	5908252968107
VWFX85-L	70-85"	80 kg	600-400 mm	11 kg	826x500x80 mm	5908252969197
VWFX95-L	90-95"	130 kg	800-600 mm	130 kg	1076x670x100 mm	5908252964987



The VWPOP is purpose designed for easy and fast servicing of recessed video wall installations. The simple one touch „pop out” mechanism allows full extension of the display out of the videowall so access and servicing can be performed quickly and safely. Tool-less micro-adjustment is included for seamless alignment of the displays and precision dedicated spacers eliminate requirement for on-site calculations and measurements.

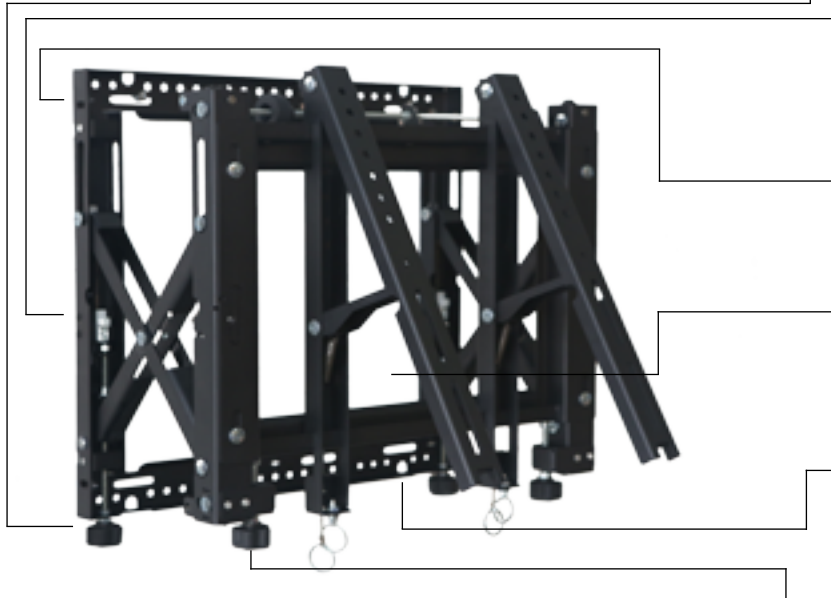

FEATURES

- Fast Release Pop-Out mechanism can be adjusted for varying display weights, ensuring safe and controlled extension.
- Fast Release Pop-out mechanism provides convenient display access designed for used in enclosed or recessed installations.
- Pop-out mechanism can be temporarily removed with security locking screw to prevent unintentional pop-outs.
- Open Frame design allows full electrical wiring access and Integrated cable management strips make display-to-display cabling simple.
- Sequentially drilled wall plate and precision dedicated display spacers eliminate requirement for on-site calculations.
- Tool-less independent 8-point micro-adjustment provides seamless alignment of the displays.

tool-less micro-adjustment



full service access



dedicated spacers



SPACERS

ACCESSORIES



PRODUCT SPECIFICATION

Dimensions	Weight	Max capacity	Colors
1084x700x100 mm	30 kg	120 kg	black

PACKAGE SPECIFICATION

Dimensions	Weight	Package	EAN
1100x740x120 mm	31,5 kg	brown box	5908252968176



PRODUCT	SCREEN SIZE	MAX. CAPACITY	VESA	WEIGHT	DIMENSIONS	EAN
VWPOP65-P	40-65"	60 kg	400-600 mm	12,5 kg	512x530x80 mm	5908252968596
VWPOP85-P	70-85"	80 kg	400-300 mm	12,5 kg	512x530x80 mm	5908252968596
VWPOP95-P	90-95"	130 kg	600-600 mm	30 kg	876x670x100 mm	5908252968176



VWFS Series - Full Service Universal Video Wall, Portrait

FEATURES

The VWFS Series is purpose designed for easy and fast servicing in video wall installations. The full service mechanism allows extension of the display out of the videowall so access and servicing can be performed quickly and safely. Tool-less micro-adjustment is included for seamless alignment of the displays and precision dedicated spacers eliminate requirement for on-site calculations and measurements.

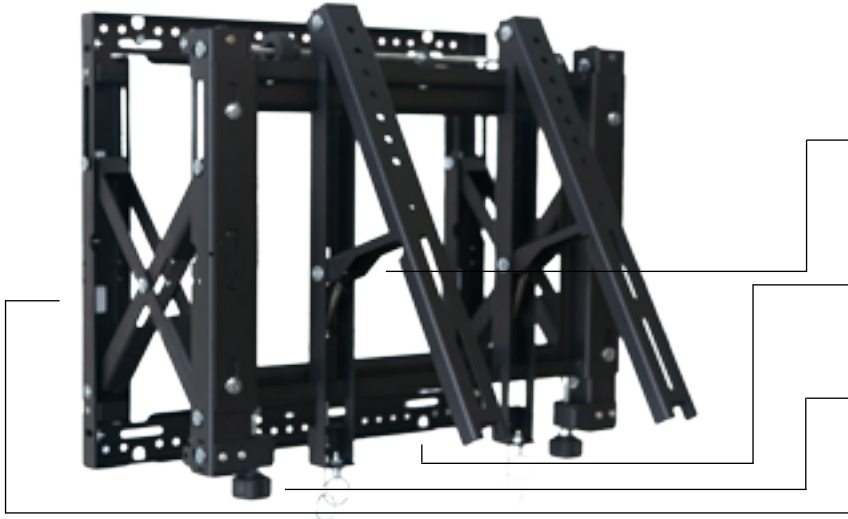

- Security padlock for anti-theft deterrent ensures increased security in public areas.
- Mechanism extension includes upward tilt position with prop stands holding weight of display for easy and safe servicing.
- Open Frame design allows full electrical wiring access and Integrated cable management strips make display-to-display cabling simple.
- Sequentially drilled wall plate and precision dedicated display spacers eliminate requirement for on-site calculations.
- Tool-less independent 8-point micro-adjustment provides seamless alignment of the displays.
- Pull-out/prop-open mechanism provides quick and easy access for servicing.

tool-less micro-adjustment



security padlock



dedicated spacers



ACCESSORIES

SPACERS



PRODUCT	SCREEN SIZE	MAX. CAPACITY	MAX. VESA	WEIGHT	DIMENSIONS	EAN
VWFS65-P	42-65"	60 kg	400-600 mm	12 kg	512x500x80 mm	5908252968565
VWFS85-P	70-85"	80 kg	400-300 mm	12 kg	512x500x80 mm	5908252968145
VWFS95-P	90-95"	130 kg	600-600 mm	24 kg	876x670x100 mm	5908252966356



The VWFX Series is purpose designed for easy and fast installation in video wall installations and for forward tilting walls and manu board applications up to 45°. The VWFX65-L is designed for modular use with models VWPOP and VWFS or alternatively where full service access is not required. Tool-less micro-adjustment is included for seamless alignment of the displays and precision dedicated spacers eliminate requirement for on-site calculations and measurements.

FEATURES

- Security padlock for anti-theft deterrent ensures increased security in public areas.
- Designed for use in forward tilting walls and menu board applications up to 45°.
- Sequentially drilled wall plate and precision dedicated display spacers eliminate requirement for on-site calculations.
- Tool-less independent 8-point micro-adjustment provides seamless alignment of the displays.
- Adjustable VESA mounting patterns from 100 x 100 up to 600 x 400
- Modular mount for unlimited video wall display configurations, can be used with models VWPOP and VWFS.

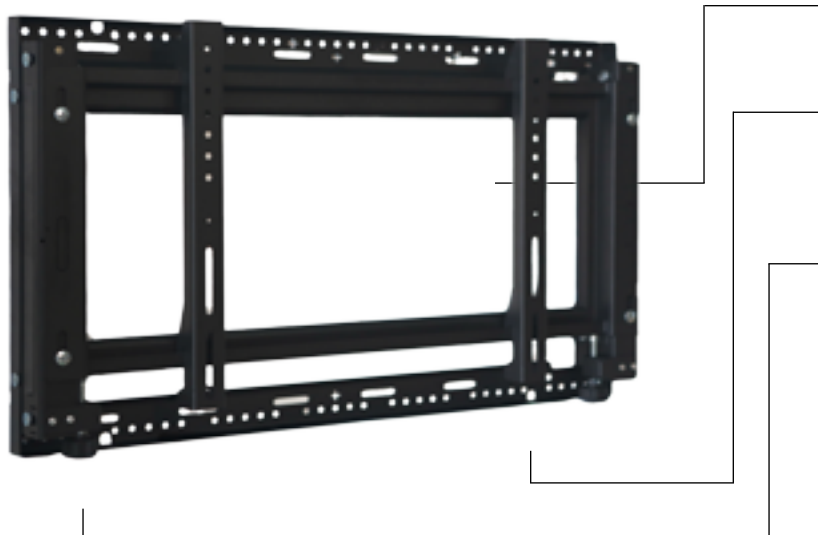

tool-less micro-adjustment



security padlock



dedicated spacers



ACCESSORIES

SPACERS



PRODUCT	SCREEN SIZE	MAX. CAPACITY	MAX. VESA	WEIGHT	DIMENSIONS	EAN
VWFX65-P	42-65"	60 kg	400-300 mm	9,5 kg	2550x1200x900 mm	5908252968602
VWFX85-P	70-85"	80 kg	600-400 mm	9,5 kg	514x500x80 mm	5908252966363
VWFX95-P	90-95"	130 kg	600-600 mm	30 kg	8760x670x100 mm	5908252968107



The VWW2255POP-L is purpose designed for easy and fast servicing of recessed video wall installations. The simple one touch „pop out“ mechanism allows full extension of the display out of the videowall so access and servicing can be performed quickly and safely.

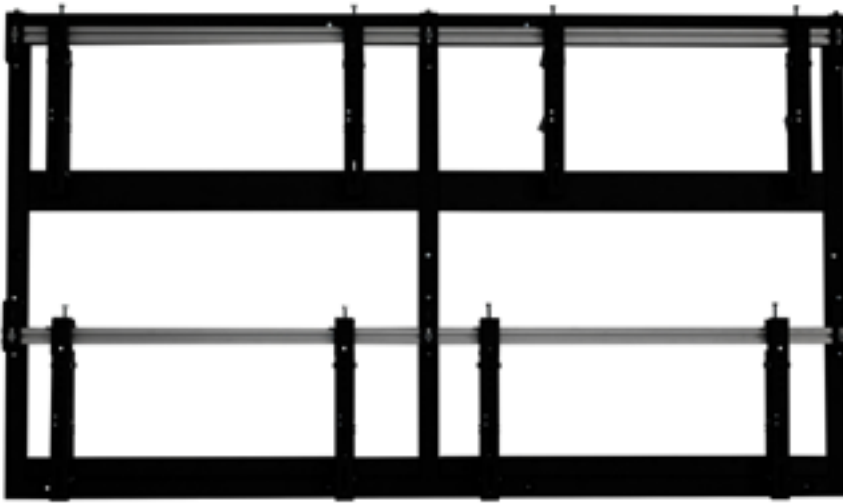

FEATURES

- Tool-less independent 8-point micro-adjustment provides seamless alignment of the displays.
- Pull-out/prop-open mechanism provides quick and easy access for servicing.
- Open Frame design allows full electrical wiring access and integrated cable management strips make display-to-display cabling simple.
- Adjustable VESA mounting patterns from 100 x 100 up to 600 x 400.

FEATURES



50"-55"



min.
100x100 mm
max.
600x400 mm



200 kg



min.
100x100
max.
400x600
mm

PRODUCT SPECIFICATION

Dimensions	Weight	Max capacity	Colors
2100x1210x100 mm	52 kg	200 kg	black

PACKAGE SPECIFICATION

Dimensions	Weight	Package	EAN
2150x1300x150 mm	14 kg	brown box	5908252962600

TECHNICAL

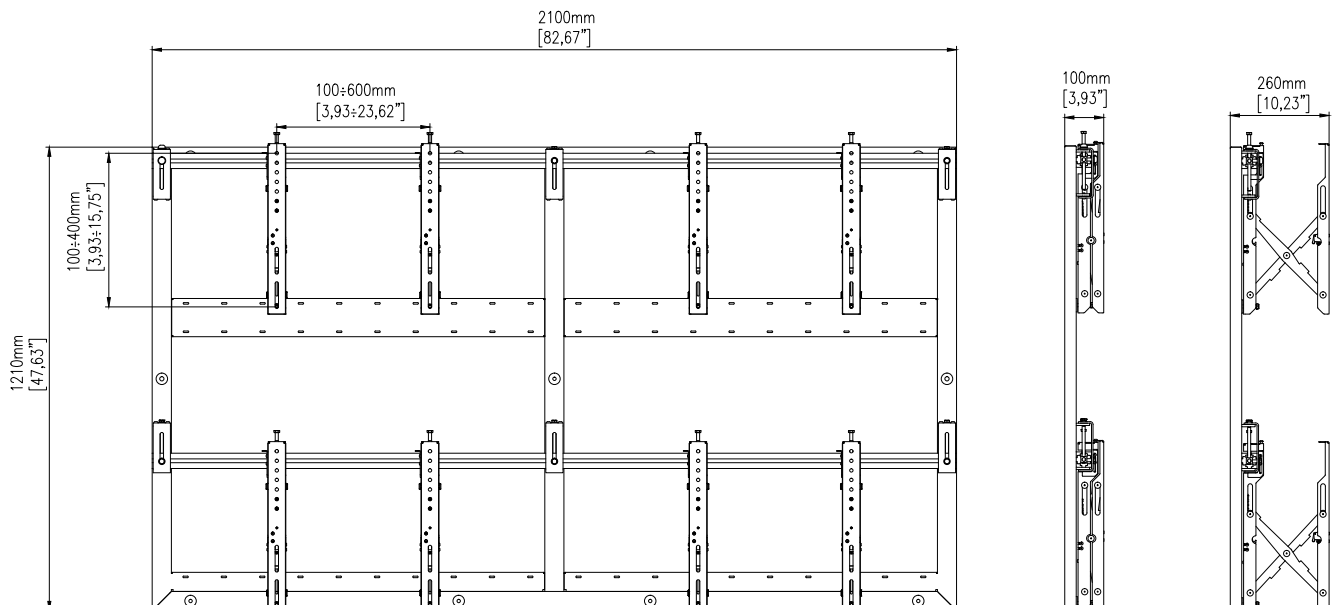



FEATURES





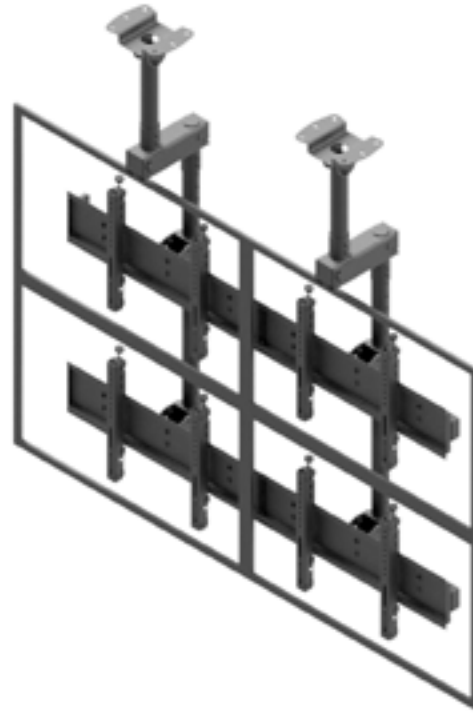

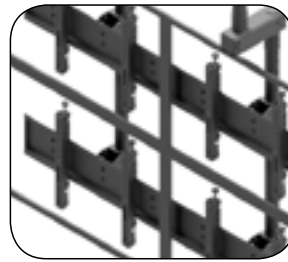
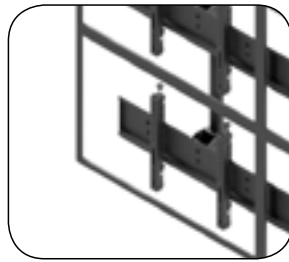
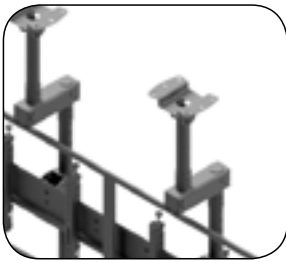

- Modular mount - the possibility of screens configuration
- Tool-less independent 8-point microadjustment provides seamless alignment of the displays
- Open Frame design allows full electrical wiring access and integrated cable management strips make display-to-display cabling simple
- Adjustable VESA mounting patterns from 100x100 up to 600x400

**NEW
PRODUCT**



FEATURES PHOTO



MONITOR CONFIGURATION	PRODUCT	SCREEN SIZE	MAX. CAPACITY	MAX. VESA	WEIGHT	DIMENSIONS	EAN
	VWC2247-L	40-47"	200 kg	100-600 mm	100 kg	2000x1800x330 mm	5908252966820
	VWC2257-L	50-57"	180 kg	100-600 mm	120 kg	2200x2200x330 mm	5908252966844
	VWC2347-L	40-47"	180 kg	100-600 mm	120 kg	2600x1800x330 mm	5908252966936
	VWC2357-L	50-57"	160 kg	100-600 mm	140 kg	2800x2200x330 mm	5908252966950
	VWC3247-L	40-47"	300 kg	100-600 mm	150 kg	2000x2700x330 mm 2200x3300x330 mm	5908252966998
	VWC3257-L	50-57"	270 kg	100-600 mm	180 kg	2200x3300x330 mm	5908252967018
	VWC3347-L	40-47"	280 kg	100-600 mm	170 kg	2600x2700x330 mm	5908252966875
	VWC3357-L	50-57"	250 kg	100-600 mm	200 kg	2800x3300x330 mm	5908252966899



VWT Series - Trolley Video Walls, Landscape

**NEW
PRODUCT**







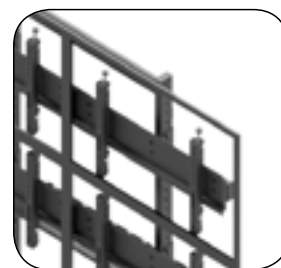
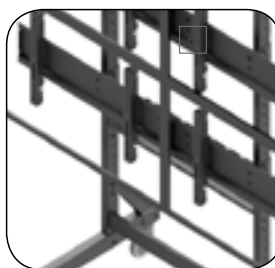

FEATURES

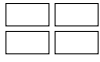
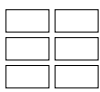
- Screen Layout: 2 x 2 landscape (a portrait version is also available)
- Mobility: 4 freely-rotating casters with individual brakes
- Mounting System: 8-point tool-less micro-adjustment
- VESA Mounting: from 100x100 to 600x400mm

FEATURES PHOTO



MONITOR CONFIGURATION	PRODUCT	SCREEN SIZE	MAX. CAPACITY	MAX. VESA	WEIGHT	DIMENSIONS	EAN
	VWT2247-L	40-47"	220 kg	100-600 mm	100 kg	1970x1800x900 mm	5908252966370
	VWT2257-L	50-57"	210 kg	100-600 mm	110 kg	1970x2200x900 mm	5908252966387
	VWT2347-L	40-47"	205 kg	100-600 mm	130 kg	2570x1800x900 mm	5908252966479
	VWT2357-L	50-57"	190 kg	100-600 mm	140 kg	2570x2200x900 mm	5908252966493
	VWT3247-L	40-47"	305 kg	100-600 mm	145 kg	1970x2700x900 mm	5908252966530
	VWT3257-L	50-57"	305 kg	100-600 mm	155 kg	1970x3300x900 mm	5908252966554
	VWT3347-L	40-47"	305 kg	100-600 mm	195 kg	2570x2700x900 mm	5908252966417
	VWT3357-L	50-57"	290 kg	100-600 mm	210 kg	2570x3300x900 mm	5908252966431



FEATURES

- Tool-less independent 8-point micro adjustment provides seamless alignment of the displays
- Universal range of Vesa mounts and adapter included
- Flexible option of mounting 4 screens
- Fully height adjustable

**NEW
PRODUCT**



FEATURES PHOTO

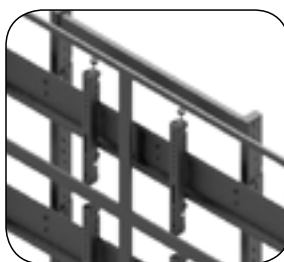

MONITOR CONFIGURATION

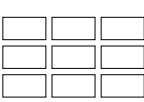
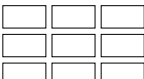
MONITOR CONFIGURATION	PRODUCT	SCREEN SIZE	MAX. CAPACITY	MAX. VESA	WEIGHT	DIMENSIONS	EAN
	VWS2247-L	40-47"	220 kg	100-600 mm	105 kg	2000x1800x370 mm	5908252966592
	VWS2257-L	50-57"	210 kg	100-600 mm	115 kg	2000x2200x370 mm	5908252966615
	VWS2347-L	40-47"	220 kg	100-600 mm	125 kg	2600x1800x370 mm	5908252966714
	VWS2357-L	50-57"	210 kg	100-600 mm	135 kg	2600x2200x370 mm	5908252966738
	VWS3247-L	40-47"	300 kg	100-600 mm	180 kg	2000x2700x370 mm	5908252966783
	VWS3257-L	50-57"	280 kg	100-600 mm	200 kg	2000x3300x370 mm	5908252966790
	VWS3347-L	40-47"	185 kg	100-600 mm	185 kg	2600x2200x370 mm	5908252966653
	VWS3357-L	50-57"	280 kg	100-600 mm	200 kg	2600x3300x370 mm	5908252966684



VWFC Series - Video Wall Ceiling-Floor Mounted, Landscape

**NEW
PRODUCT**



FEATURES

- Tool-less independent 8-point micro adjustment provides seamless alignment of the displays
- Universal range of Vesa mounts and adapter included
- Flexible option of mounting 4 screens customized height according to customer's requirements

FEATURES PHOTO

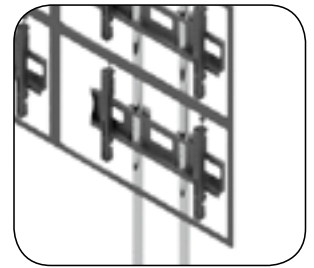
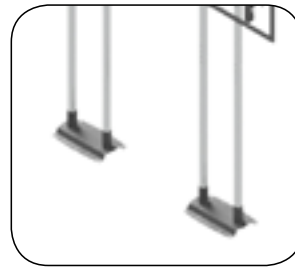
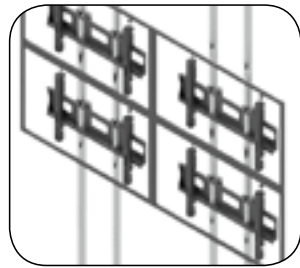

MONITOR CONFIGURATION

MONITOR CONFIGURATION	PRODUCT	SCREEN SIZE	MAX. CAPACITY	MAX. VESA	WEIGHT	DIMENSIONS	EAN
	VWFC2247-L	40-47"	220 kg	100-600 mm	100 kg	3000x1900x260 mm	5908252967056
	VWFC2257-L	50-57"	210 kg	100-600 mm	110 kg	3000x1900x260 mm	5908252967070
	VWFC2347-L	40-47"	220 kg	100-600 mm	110 kg	3000x1900x260 mm	5908252967179
	VWFC2357-L	50-57"	210 kg	100-600 mm	120 kg	3000x1900x260 mm	5908252967193
	VWFC3247-L	40-47"	220 kg	100-600 mm	135 kg	3000x3000x260 mm	5908252967230
	VWFC3257-L	50-57"	210 kg	100-600 mm	150 kg	3000x3000x260 mm	5908252967254
	VWFC3347-L	40-47"	220 kg	100-600 mm	160 kg	3000x3000x260 mm	5908252967117
	VWFC3357-L	50-57"	210 kg	100-600 mm	175 kg	3000x3000x260 mm	5908252967131



FEATURES

- Tool-less independent 8-point micro adjustment provides seamless alignment of the displays
- Universal range of Vesa mounts and adapter included
- Flexible option of mounting 4 screens
- Fully height adjustable





**NEW
PRODUCT**

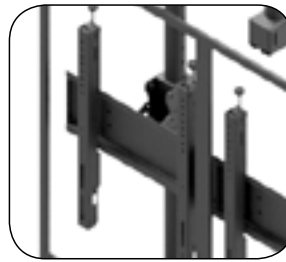
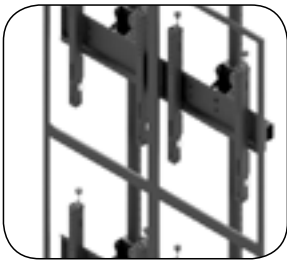

FEATURES PHOTO

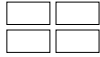

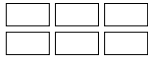
MONITOR CONFIGURATION

MONITOR CONFIGURATION	PRODUCT	SCREEN SIZE	MAX. CAPACITY	MAX. VESA	WEIGHT	DIMENSIONS	EAN
	VWC2247-P	40-47"	200 kg	100-600 mm	100 kg	2700x1200x330 mm	5908252966837
	VWC2257-P	50-57"	180 kg	100-600 mm	120 kg	2700x2400x330 mm	5908252966851
	VWC2347-P	40-47"	300 kg	100-600 mm	135 kg	2700x1800x260 mm	5908252966943
	VWC2357-P	50-57"	300 kg	100-600 mm	140 kg	2700x1800x260 mm	5908252966967



VWT Series - Trolley Video Walls, Portrait

**NEW
PRODUCT**



FEATURES

- Tool-less independent 8-point micro adjustment provides seamless alignment of the displays
- Universal range of Vesa mounts and adapters included
- Flexible option of mounting 4 screens customized height according to customer's requirements

FEATURES PHOTO

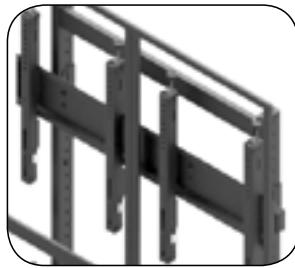

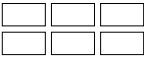
MONITOR CONFIGURATION	PRODUCT	SCREEN SIZE	MAX. CAPACITY	MAX. VESA	WEIGHT	DIMENSIONS	EAN
	VWT2247-P	40-47"	220 kg	100-600 mm	100 kg	2550x1200x900 mm	5908252966370
	VWT2257-P	50-57"	210 kg	100-600 mm	110 kg	2550x1400x900 mm	5908252966387
	VWT2347-P	40-47"	205 kg	100-600 mm	130 kg	2550x1800x900 mm	5908252966486
	VWT2257-P	50-57"	190 kg	100-600 mm	140 kg	2550x1800x900 mm	5908252966509



FEATURES

- Tool-less independent 8-point micro adjustment provides seamless alignment of the displays
- Universal range of Vesa mounts and adapter included
- Flexible option of mounting 4 screens
- Fully height adjustable



FEATURES PHOTO

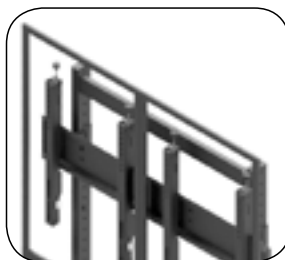
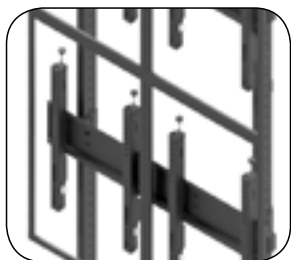

MONITOR CONFIGURATION	PRODUCT	SCREEN SIZE	MAX. CAPACITY	MAX. VESA	WEIGHT	DIMENSIONS	EAN
	VWS2247-P	40-47"	220 kg	100-600 mm	105 kg	2600x1100x370 mm	5908252966608
	VWS2257-P	50-57"	210 kg	100-600 mm	115 kg	2700x2400x330 mm	5908252966622
	VWS2347-P	40-47"	220 kg	100-600 mm	115 kg	2600x1100x370 mm	5908252966721
	VWS2357-P	50-57"	210 kg	100-600 mm	125 kg	2600x1400x370 mm	5908252966745



VWFC Series - Video Wall Ceiling-Floor Mounted, Portrait

**NEW
PRODUCT**





FEATURES

- Tool-less independent 8-point micro adjustment provides seamless alignment of the displays
- Universal range of Vesa mounts and adapter included
- Flexible option of mounting 4 screens customized height according to customer's requirements

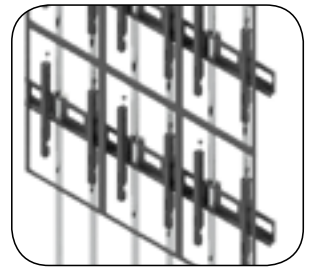
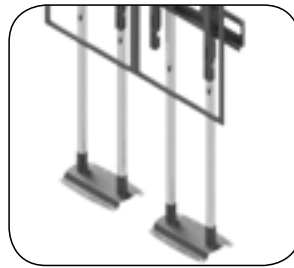
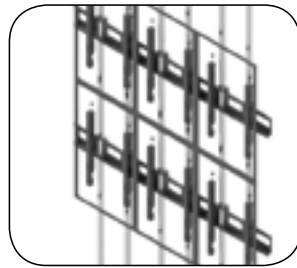
FEATURES PHOTO

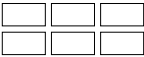

MONITOR CONFIGURATION	PRODUCT	SCREEN SIZE	MAX. CAPACITY	MAX. VESA	WEIGHT	DIMENSIONS	EAN
	VWFC2247-P	40-47"	220 kg	100-600 mm	100 kg	3000x1200x260 mm	5908252967063
	VWFC2257-P	50-57"	210 kg	100-600 mm	110 kg	3000x1400x260 mm	5908252967087
	VWFC3247-P	40-47"	220 kg	100-600 mm	135 kg	3000x1800x260 mm	5908252967247
	VWFC3257-P	50-57"	210 kg	100-600 mm	150 kg	3000x1800x260 mm	5908252967261



FLAT PANEL WALL MOUNTS

FEATURES

Level bubble – ensures quick and simple levelling even on uneven walls

Post Installation adjustment – fine correction for height and level for perfect positioning

Tilt adjustment – graduated tilt function allows incremental tilt for ideal viewing angle

Slimline – Ultra low profile design provides seamless integration to the wall



37"-46" Superslim Wall Mount

ECB300

FEATURES

- Universal Vesa compatibility
- Slim profile for minimum distance from the wall
- Spirit Level allows easy and accurate installation
- Max. capacity 25 kg

TECHNICAL



min.
100x100 mm
max.
400x400 mm



37"-46"



25 mm



25 kg

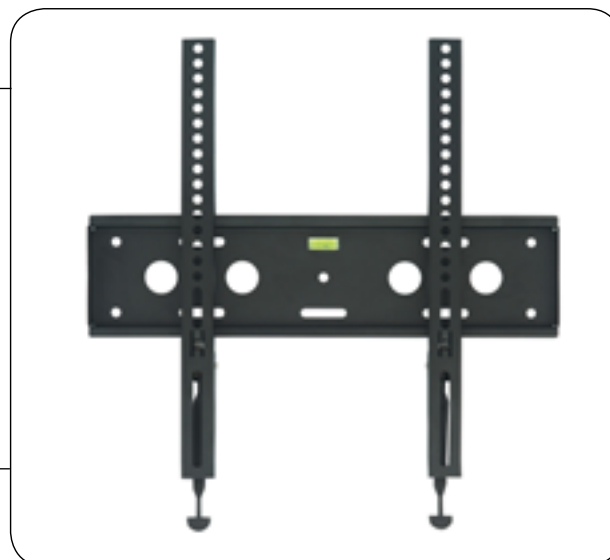

SUPER SLIM FIXED WALL MOUNTS

PRODUCT SPECIFICATION

Dimensions	Weight	Max capacity	Colour	Packaging dimensions	EAN
440x484x25 mm	0,9 kg	25 kg	black silver	490x130x30 mm	5908252968725 5908252968008



26"-40" Fixed Wall Mount

EWB100

SUPER SLIM FIXED WALL MOUNTS



FEATURES

- Universal Vesa compatibility
- Slim profile for minimum distance from the wall
- Open frame design for easy wiring and installation access
- Spirit Level allows easy and accurate installation
- Max. capacity 40 kg

TECHNICAL



min.
75x75 mm
max.
400x200 mm



26"-40"



25,5 mm



min.
60x65 mm
max.
440x337,5 mm



40 kg

PRODUCT SPECIFICATION

Dimensions	Weight	Max capacity	Colour	Packaging dimensions	EAN
495x370x25,5 mm	1,5 kg	40 kg	black silver	500x205x35 mm	5908252963485 5908252963492



SUPER SLIM FIXED WALL MOUNTS



FEATURES

- Universal Vesa compatibility
- Slim profile for minimum distance from the wall
- Open frame design for easy wiring and installation access
- Spirit Level allows easy and accurate installation
- Max. capacity 40 kg

TECHNICAL

min.
75x75 mm
max.
800x400 mm

40"-65"

25,5 mm

min.
60x65 mm
max.
825x427,5 mm

40 kg

PRODUCT SPECIFICATION

Dimensions	Weight	Max capacity	Colour	Packaging dimensions	EAN
850x470x25,5 mm	2,3 kg	40 kg	black silver	860x205x35 mm	5908252963508 5908252963515



FEATURES

- Universal Vesa compatibility
- Additional Mounting Options available
- Padlock security included for theft protection
- Slim profile for minimum distance from the wall
- Heavy duty 3 mm professional gauge steel

TECHNICAL

min.
75x75 mm
max.
600x400 mm

37"-65"

25 mm

min.
60x68 mm
max.
820x455 mm

40 kg



SUPER SLIM FIXED WALL MOUNTS

PRODUCT SPECIFICATION

Dimensions	Weight	Max capacity	Colour	Packaging dimensions	EAN
665x500x25 mm	3,25 kg	40 kg	black silver	895x130x40 mm	5908252962945 5908252962952



37"-65" Fixed Wall Mount

XSM1

FEATURES

- Universal Vesa compatibility
- Additional Mounting Options available
- Padlock security included for theft protection
- Slim profile for minimum distance from the wall
- Heavy duty 3 mm professional gauge steel

TECHNICAL

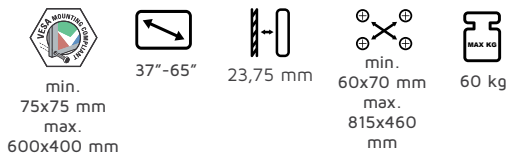

SUPER SLIM FIXED WALL MOUNTS

PRODUCT SPECIFICATION

Dimensions	Weight	Max capacity	Colour	Packaging dimensions	EAN
694x500x23 mm	2,35 kg	60 kg	black silver	920x75x40 mm	5908252963027 5908252963034



26"-42" Fixed Wall Mount

LWB1

FIXED WALL MOUNTS



FEATURES

- TUV safety certificate
- Universal Vesa compatibility
- Heavy duty 3 mm professional gauge steel
- Security bolts to prevent accidental screen movement
- Max. capacity 60 kg

TECHNICAL

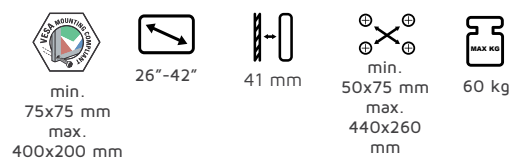

PRODUCT SPECIFICATION

Dimensions	Weight	Max capacity	Colour	Packaging dimensions	EAN
540x260x41 mm	3,1 kg	60 kg	black silver	540x300x45 mm	5908252960194 5908252960200



FIXED WALL MOUNTS

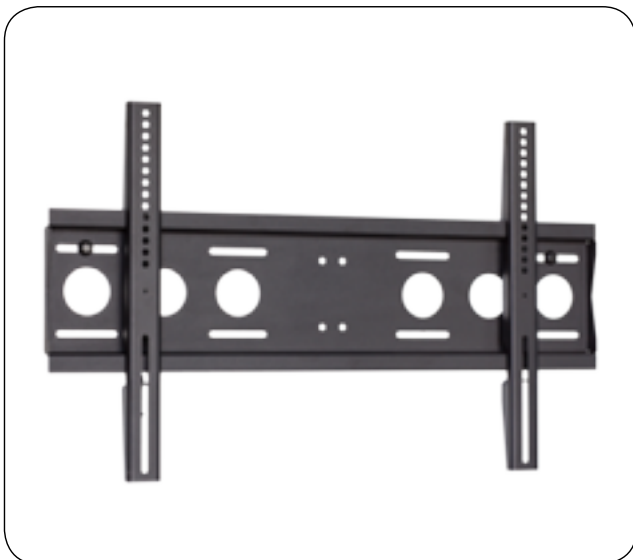

FEATURES

- TUV safety certificate
- Universal Vesa compatibility
- Heavy duty 3 mm professional gauge steel
- Security bolts to prevent accidental screen movement
- Max. capacity 80 kg

TECHNICAL

PRODUCT SPECIFICATION

Dimensions	Weight	Max capacity	Colour	Packaging dimensions	EAN
800x500x41 mm	4,7 kg	80 kg	black silver	820x220x38 mm	5908252960156 5908252960163



FEATURES

- Universal Vesa compatibility
- Heavy duty 3 mm professional gauge steel
- Security bolts to prevent accidental screen movement
- Max. capacity 80 kg

TECHNICAL

FIXED WALL MOUNTS



PRODUCT SPECIFICATION

Dimensions	Weight	Max capacity	Colour	Packaging dimensions	EAN
900x500x48,5 mm	5,3 kg	80 kg	black silver	910x220x40 mm	5908252960859 5908252960866



80"-95" Fixed Wall Mount

XWB1

FEATURES

- Universal Vesa compatibility
- Heavy duty 3 mm professional gauge steel
- Security bolts to prevent accidental screen movement
- Max. capacity 110 kg

TECHNICAL

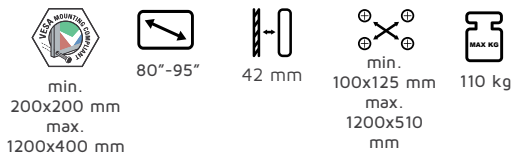

FIXED WALL MOUNTS

PRODUCT SPECIFICATION

Dimensions	Weight	Max capacity	Colour	Packaging dimensions	EAN
1260x540x42 mm	11,3 kg	110 kg	black silver	1280x320x60 mm	5908252960897 5908252960903



26"-40" Portrait Wall Mount

LWB3

FIXED WALL MOUNTS



FEATURES

- Universal Vesa compatibility
- Heavy duty 3 mm professional gauge steel
- Security bolts to prevent accidental screen movement
- Max. capacity 60 kg

TECHNICAL

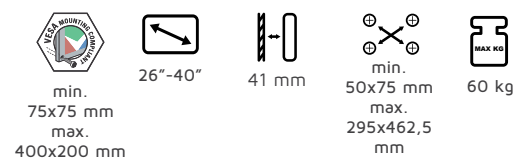

PRODUCT SPECIFICATION

Dimensions	Weight	Max capacity	Colour	Packaging dimensions	EAN
350x490x41 mm	2,6 kg	60 kg	black silver	540x300x45 mm	5908252961566 5908252961573



FIXED WALL MOUNTSS



FEATURES

- Universal Vesa compatibility
- Heavy duty 3 mm professional gauge steel
- Security bolts to prevent accidental screen movement
- Max. capacity 80 kg

TECHNICAL

min. 100x100 mm
max. 600x400 mm

42"-60"

44,6 mm

min. 55x100 mm
max. 400x750 mm

80 kg

PRODUCT SPECIFICATION

Dimensions	Weight	Max capacity	Colour	Packaging dimensions	EAN
458x780x44,6 mm	7 kg	80 kg	black silver	790x350x75 mm	5908252960910 5908252960927



FEATURES

- Universal Vesa compatibility
- Heavy duty 3 mm professional gauge steel
- Security bolts to prevent accidental screen movement
- Max. capacity 60 kg

TECHNICAL

min. 100x100 mm
max. 800x400 mm

65"-75"

44,6 mm

min. 55x100 mm
max. 495x920 mm

80 kg

FIXED WALL MOUNTS



PRODUCT SPECIFICATION

Dimensions	Weight	Max capacity	Colour	Packaging dimensions	EAN
550x950x44,6 mm	9,8 kg	80 kg	black silver	1280x320x60 mm	5908252961252 5908252961900



80"-95" Portrait Wall Mount

XWB3

FEATURES

- Universal Vesa compatibility
- Heavy duty 3 mm professional gauge steel
- Security bolts to prevent accidental screen movement
- Max. capacity 80 kg

TECHNICAL

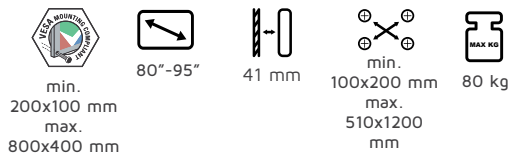

FIXED WALL MOUNTS

PRODUCT SPECIFICATION

Dimensions	Weight	Max capacity	Colour	Packaging dimensions	EAN
600x1245x41 mm	9,8 kg	80 kg	black silver	1280x320x60 mm	5908252961924 5908252961917



26"-40" Portrait Wall Mount

LWB2

TILTING WALL MOUNTS



FEATURES

- TUV safety certificate
- Security bolts to prevent accidental screen movement
- Adjustable Tilt Angle included from 5° to 13°
- Heavy duty 3 mm professional gauge steel
- Max. capacity 60 kg

TECHNICAL

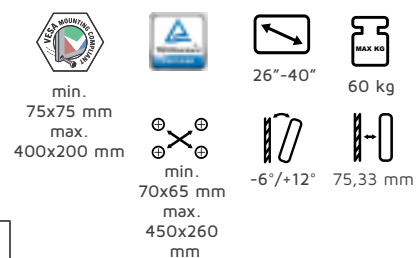

PRODUCT SPECIFICATION

Dimensions	Weight	Max capacity	Colour	Packaging dimensions	EAN
350x490x41 mm	2,6 kg	60 kg	black silver	540x300x45 mm	5908252961566 5908252961573



TILTING WALL MOUNTS



FEATURES

- TUV safety certificate
- Security bolts to prevent accidental screen movement
- Adjustable Tilt Angle included from 6,5° to 12°
- Heavy duty 3 mm professional gauge steel
- Max. capacity 80 kg

TECHNICAL

min. 100x100 mm
max. 600x400 mm

42"-60"

80 kg

min. 70x95 mm
max. 740x460 mm

-6,5°/+12°

77,4 mm

PRODUCT SPECIFICATION

Dimensions	Weight	Max capacity	Colour	Packaging dimensions	EAN
800x500x77,4 mm	5,5 kg	80 kg	black silver	805x220x80 mm	5908252960170 5908252960187



FEATURES

- Universal Vesa compatibility
- Security bolts to prevent accidental screen movement
- Adjustable Tilt Angle included from 6° to 11°
- Heavy duty 3 mm professional gauge steel
- Max. capacity 80 kg

TECHNICAL

min. 100x100 mm
max. 800x400 mm

60"-65"

77,4 mm

min. 70x95 mm
max. 845x460 mm

80 kg

-6°/+11°

TILTING WALL MOUNTS



PRODUCT SPECIFICATION

Dimensions	Weight	Max capacity	Colour	Packaging dimensions	EAN
910x220x75 mm	6,5 kg	80 kg	black silver	910x220x75 mm	5908252960873 5908252960880



42"-65" Tilt Wall Mount

EWB250

FEATURES

- Universal Vesa compatibility
- Slim profile for minimum distance from the wall
- Adjustable Tilt Angle from 0° to 12°
- Open frame design for easy wiring and installation access
- Spirit Level allows easy and accurate installation

TECHNICAL

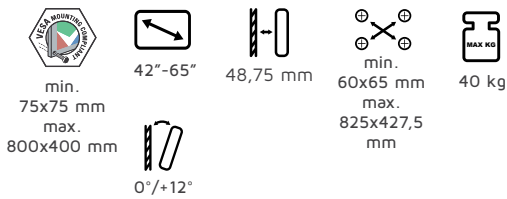

TILTING WALL MOUNTS

PRODUCT SPECIFICATION

Dimensions	Weight	Max capacity	Colour	Packaging dimensions	EAN
850x470x48,75 mm	2,65 kg	40 kg	black silver	860x205x65 mm	5908252963546 5908252963553



26"-40" Swing Arm Wall Mount

LWR1

SWING ARM WALL MOUNTS



FEATURES

- Universal Vesa compatibility
- Adjustable Tilt Angle from -6° to +9°
- Full articulation enables easier maintenance
- Includes cable management
- Max. capacity 60 kg

TECHNICAL

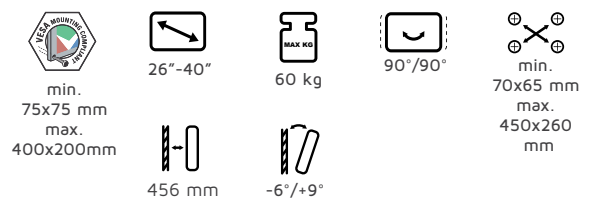

PRODUCT SPECIFICATION

Dimensions	Weight	Max capacity	Colour	Packaging dimensions	EAN
456x540x300 mm	6,6 kg	60 kg	black silver	245x130x585 mm	5908252961818 5908252961931



FEATURES

- Universal Vesa compatibility
- Adjustable wall extension from 62 to 638 mm
- Slim profile for minimum distance from the wall
- Adjustable Tilt Angle from 0° to 10°
- Security bolts to prevent accidental screen movement

PRODUCT SPECIFICATION

Dimensions	Weight	Max capacity	Colour	Packaging dimensions	EAN
638x660x440 mm	6,8 kg	25 kg	black silver	700x300x80 mm	5908252965892 5908252965908

TECHNICAL



min.
200x200
max.
600x400
mm



32"-50"
62/638 mm



MAX KG
25 kg



0°/+10°



90°-90°



FEATURES

- Universal Vesa compatibility
- Adjustable wall extension from 150 to 700 mm
- Supporting heavy displays up to 120 kg
- Adjustable Tilt Angle from -10° to +10°
- Vertical and horizontal position of the screen

PRODUCT SPECIFICATION

Dimensions	Weight	Max capacity	Colour	Packaging dimensions	EAN
700x850x520 mm	25 kg	120 kg	black silver	870x500x200 mm	5908252968664 5908252968800

TECHNICAL



42"-90"

min. 100x100 mm
max. 600x400 mm



120 kg



0°/90°



min. 100x100 mm
max. 600x450 mm



min. 150 mm
max. 700 mm



-10°/+10°



SWING ARM WALL MOUNTS



FEATURES

- Universal Vesa compatibility
- Adjustable Tilt Angle from -6° to +9°
- Easy position adjustment via 3 rotational axis
- Adjustable wall extension from 197 to 611 mm
- Includes cable management

TECHNICAL

PRODUCT SPECIFICATION

Dimensions	Weight	Max capacity	Colour	Packaging dimensions	EAN
611x540x300 mm	12 kg	60 kg	black silver	345x180x585 mm	5908252962235 5908252962433



FEATURES

- Universal Vesa compatibility
- Adjustable Tilt Angle from -6° to +9°
- Full articulation enables easier maintenance
- Includes cable management
- Max. capacity 80 kg

TECHNICAL



SWING ARM WALL MOUNTS

PRODUCT SPECIFICATION

Dimensions	Weight	Max capacity	Colour	Packaging dimensions	EAN
458x800x500 mm	7,5 kg	80 kg	black silver	810x270x105 mm	5908252961801 5908252961955



32"-50" Swing Arm Wall Mount

PWS1

FEATURES

- Universal Vesa compatibility
- Adjustable Tilt Angle from -6° to $+9^{\circ}$
- Adjustable wall extension from 169 to 613 mm
- Full articulation enables easier maintenance
- Max. capacity 80 kg

TECHNICAL

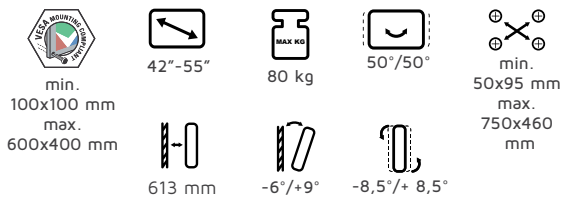

SWING ARM WALL MOUNTS

PRODUCT SPECIFICATION

Dimensions	Weight	Max capacity	Colour	Packaging dimensions	EAN
613x800x500 mm	10 kg	80 kg	black silver	810x280x950 mm	5908252961795 5908252961948



42"-70" Heavy Duty Swing Arm Wall Mount

RPWS1

SWING ARM WALL MOUNTS



FEATURES

- Universal Vesa compatibility
- Adjustable wall extension from 150 to 800 mm
- Supporting heavy displays up to 120 kg
- Adjustable Tilt Angle from -10° to $+10^{\circ}$
- Vertical and horizontal position

TECHNICAL

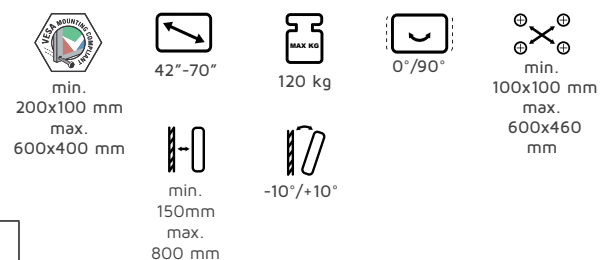

PRODUCT SPECIFICATION

Dimensions	Weight	Max capacity	Colour	Packaging dimensions	EAN
800x980x520 mm	22 kg	120 kg	black silver	1000x350x200 mm	5908252968404 5908252968015



FEATURES

- Universal range of Vesa mounting options
- Telescopic mounting - with flexible height adjustment
- Distance from the ceiling to the screen 1332 to 1770 mm
- Internal Cable management in pole
- Adjustable tilt angle from 0° to 22° of the screen

PRODUCT SPECIFICATION

Dimensions	Weight	Max capacity	Colour	Packaging dimensions	EAN
1170x800x183 mm	12,7 kg	30 kg	black silver	1000x300x150 mm	5908252968626 5908252968626

TECHNICAL

min. 100x100
max. 600x400 mm

32"-47"

30 kg

90°/90°

min. 70x95 mm
max. 740x460 mm

-0°/+22°



42"-60" Dual Swing Arm Wall Mount

PWS3

FEATURES

- Universal Vesa compatibility
- Adjustable Tilt Angle from -6° to +9°
- Full articulation enables easier maintenance
- Includes cable management
- Easy position adjustment via 3 rotational axis

TECHNICAL



min.
100x100 mm
max.
600x400 mm



42"-60"



80 kg



90°/90°



min.
50x95 mm
max.
750x460 mm



min.
169 mm
max.
817 mm



-6°/+9°



HEAVY DUTY SWING ARMS

PRODUCT SPECIFICATION

Dimensions	Weight	Max capacity	Colour	Packaging dimensions	EAN
734x800x500 mm	8,9 kg	80 kg	black silver	810x280x950 mm	5908252968114 5908252968077



42"-60" Dual Swing Arm Wall Mount

PWS4

HEAVY DUTY SWING ARMS



FEATURES

- Universal Vesa compatibility
- Adjustable Tilt Angle from -6° to +9°
- Full articulation enables easier maintenance
- Includes cable management
- Easy position adjustment via 3 rotational axis

TECHNICAL



min.
100x100 mm
max.
600x400 mm



42"-60"



80 kg



0°/90°



min.
50x95 mm
max.
750x460 mm



min.
150 mm
max.
800 mm



-6°/+9°

PRODUCT SPECIFICATION

Dimensions	Weight	Max capacity	Colour	Packaging dimensions	EAN
783x800x500 mm	9,3 kg	80 kg	black silver	810x280x950 mm	5908252968060 5908252968794



FEATURES

- Universal range of Vesa mounting options
- Telescopic mounting - with flexible height adjustment
- Distance from the ceiling to the screen 1375 to 2175 mm
- Internal Cable management in pole
- Adjustable tilt angle from 0° to 22°

PRODUCT SPECIFICATION

Dimensions	Weight	Max capacity	Colour	Packageing dimensions	EAN
2175x800x200 mm	12 kg	60 kg	black silver	1310x210x210 mm	5908252968411 5908252961801

TECHNICAL



min. 100x100
max. 600x400
mm



32"-65"



60 kg



90°/90°



min. 50x95 mm
max. 750x460 mm



min. 1375 mm
max. 2175 mm



42"-65" Corner Rotating Swing Arm Wall Mount

CPWS1

FEATURES

- Universal Vesa compatibility
- Adjustable wall extension from 150 to 800 mm
- Supporting heavy displays up to 120 kg
- Adjustable Tilt Angle from 10° to 10°
- Vertical and horizontal position of the screen

TECHNICAL



min.
100x100 mm
max.
600x400 mm



42"-65"



120 kg



90°/90°



min.
100x100 mm
max.
600x460 mm



min.
150mm
max.
800 mm



-10°/+10°



HEAVY DUTY SWING ARMS

PRODUCT SPECIFICATION

Dimensions	Weight	Max capacity	Colour	Packaging dimensions	EAN
800x980x520 mm	21 kg	120 kg	black silver	1000x350x200 mm	5908252961535 5908252968121



32"-65" LCD Ceiling Mount

CMS1

FLAT SCREEN CEILING MOUNTSS



FEATURES

- Universal range of Vesa mounting options
- Distance from the ceiling to the screen 1677 mm
- Internal Cable management in pole
- Adjustable tilt angle from 12,5° to 6,5°
- Tubular chrome pole luxury finish

TECHNICAL



min.
100x100 mm
max.
600x400 mm



32"-65"



60 kg



90°/90°



min.
50x95 mm
max.
750x460 mm



1677 mm



12,5°/+6,5°

PRODUCT SPECIFICATION

Dimensions	Weight	Max capacity	Colour	Packaging dimensions	EAN
1677x800x200 mm	14,2 kg	60 kg	black silver	1310x210x210 mm	5908252968374 5908252968671



FLAT SCREEN CEILING MOUNTS



FEATURES

- Universal range of Vesa mounting options
- Telescopic mounting - with flexible height adjustment
- Distance from the ceiling to the screen 1775 to 2575 mm
- Internal Cable management in pole
- Adjustable tilt angle from 0° to 22°

TECHNICAL



PRODUCT SPECIFICATION

Dimensions	Weight	Max capacity	Colour	Packaging dimensions	EAN
1775x800x200 mm	19,7 kg	60 kg	black silver	1310x210x210 mm	5908252968640 5908252961580



FEATURES

- Universal range of Vesa mounting options
- Allows multiple installation of 2 screens
- Telescopic mounting - with flexible height adjustment
- Distance from the ceiling to the screen 1375 to 2175 mm
- Internal Cable management in pole

TECHNICAL



FLAT SCREEN CEILING MOUNTS



PRODUCT SPECIFICATION

Dimensions	Weight	Max capacity	Colour	Packaging dimensions	EAN
1450x800x326 mm	25,4 kg	120 kg	black silver	1310x210x210 mm	5908252968398 5908252961849



37"-45" Large Triple Ceiling Multi Directional Mount

CMS4

FEATURES

- Universal range of Vesa mounting options
- Allows multiple installation of 3 screens
- Adjustable tilt angle from 12° to 6,5°
- Internal Cable management in pole
- Max. capacity 120 kg

TECHNICAL

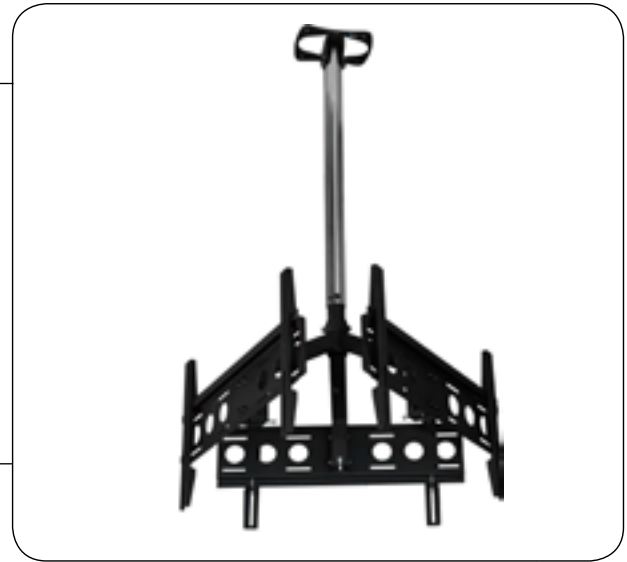
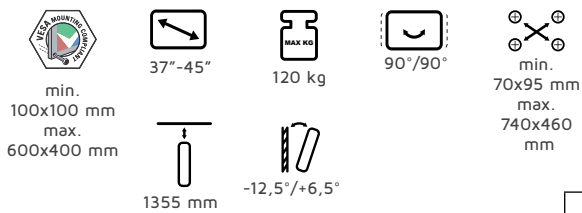

FLAT SCREEN CEILING MOUNTS

PRODUCT SPECIFICATION

Dimensions	Weight	Max capacity	Colour	Packaging dimensions	EAN
1355x800x269,5 mm	25,4 kg	120 kg	black silver	1250x620x520 mm	5908252968428



32"-46" MSV1 Screen Desk Mount

MSV1

FLAT SCREEN CEILING MOUNTS



FEATURES

- Universal range of Vesa mounting options
- Fully height adjustable
- 360° rotation for portrait or horizontal screen option
- Adjustable tilt angle from 0° to 40°
- Allows dual mounting options: through desk OR edge of desk

TECHNICAL

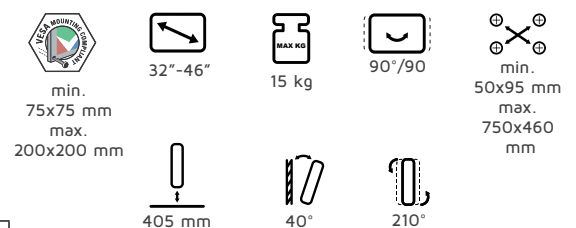

PRODUCT SPECIFICATION

Dimensions	Weight	Max capacity	Colour	Packaging dimensions	EAN
405x220x120,5 mm	4 kg	15 kg	black silver	520x240x130 mm	5908252968688 5908252968091



FLAT SCREEN CEILING MOUNTS



FEATURES

- Universal range of Vesa mounting options
- Fully height adjustable
- 360° rotation for portrait or horizontal screen option
- Adjustable tilt angle from 0° to 40°
- Allows dual mounting options: through desk OR edge of desk

TECHNICAL



min.
75x75 mm
max.
200x200 mm



32"-65"



15 kg



360°



min.
50x75 mm
max.
400x260 mm



405 mm



40°



210°

PRODUCT SPECIFICATION

Dimensions	Weight	Max capacity	Colour	Packaging dimensions	EAN
705x220x120,5 mm	5,5 kg	15 kg	black silver	820x240x130 mm	5908252968367 5908252968169



CMA1

I-beam mount

Weight	Packaging dimensions
80 kg	250x300x150 mm



CMARM60

Decorative finishing ring for ceiling mounts

Colour	Packaging dimensions	EAN
black grey	1800x360x140 mm	5908252965939 5908252965946



CMALK100

Safety padlock

Colour	Packaging dimensions	EAN
grey	1800x360x140 mm	5908252965939





MENU BOARDS

FEATURES

Modular – purpose designed for flexibility, future updates and ease of installation

Tilt – tilt alignment feature in situ enables simple and exacting multi screen alignment

Adjustment – post installation adjustment allows free movement of screens and fine alignment

Security – security lock feature and optional lock kit for secure engagement in public areas

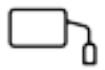

FEATURES

- Universal range of Vesa mounting options
- Internal Cable management in pole
- Adjustable tilt angle from 0° to +18°
- Max. capacity 60 kg

TECHNICAL



min.
100x100 mm
max.
600x400 mm



40"-55"



0°/+18°



min.
50x75 mm
max.
400x260 mm



60 kg

EAN

5908252962860

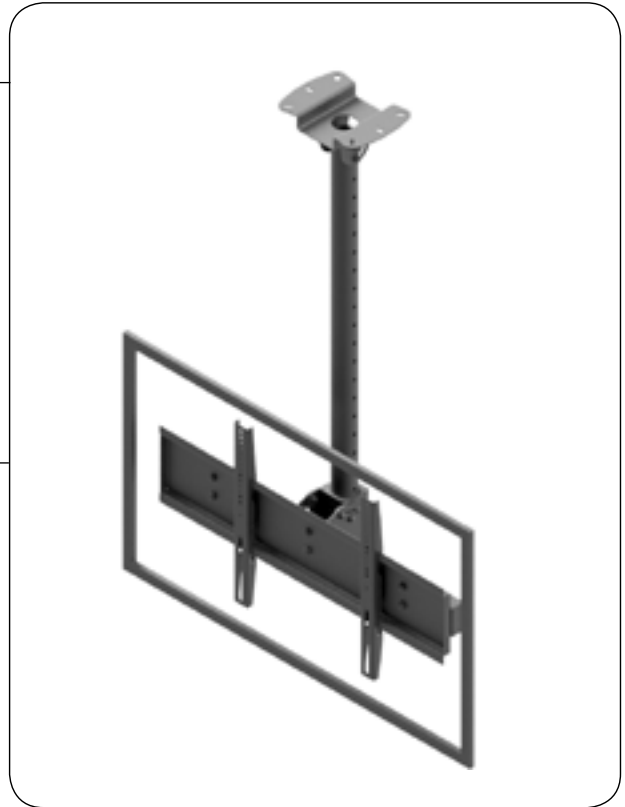

MENU BOARDS

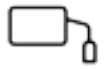

FEATURES

- Universal range of Vesa mounting options
- Allows multiple installation of 2 screens
- Internal Cable management in pole
- Adjustable tilt angle from 0° to +18°
- Max. capacity 120 kg

TECHNICAL



min.
100x100 mm
max.
600x400 mm



40"-55"



0°/+18°



min.
50x75 mm
max.
400x260 mm



120 kg

EAN

5908252962877

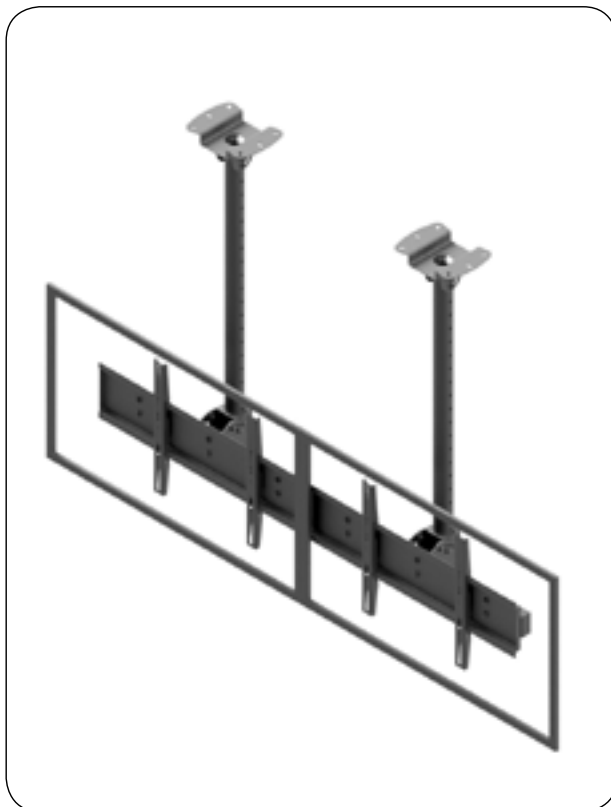

MENU BOARDS





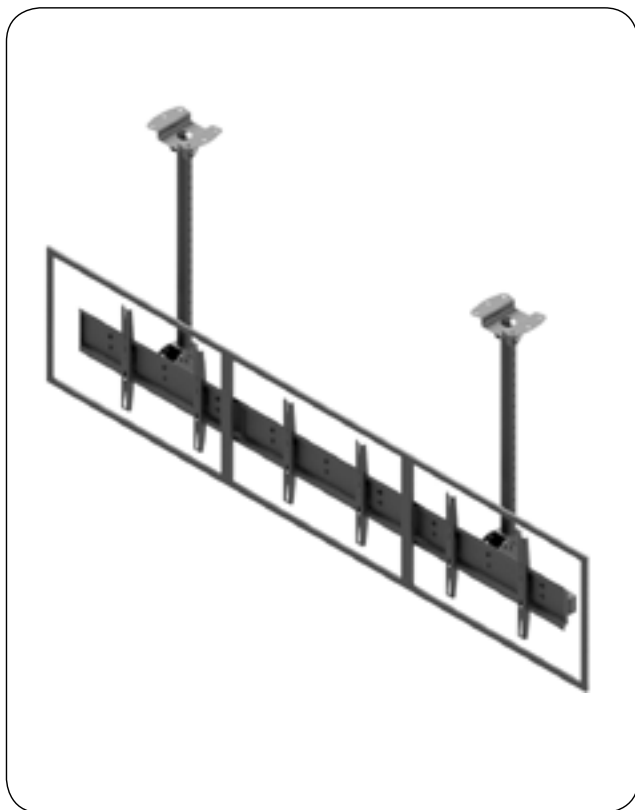

MENU BOARDS



FEATURES

- Universal range of Vesa mounting options
- Allows multiple installation of 3 screens
- Internal Cable management in pole
- Adjustable tilt angle from 0° to +18°
- Max. capacity 180 kg

TECHNICAL

				
min. 100x100 mm max. 600x400 mm	40"-55"	0°/+18°	min. 50x75 mm max. 400x260 mm	180 kg





EAN	5908252962884
-----	---------------



FEATURES

- Universal range of Vesa mounting options
- Allows multiple installation of 2 screens
- Internal Cable management in pole
- Adjustable tilt angle from 0° to +18°
- Max. capacity 120 kg

TECHNICAL

				
min. 100x100 mm max. 600x400 mm	40"-55"	0°/+18°	min. 50x75 mm max. 400x260 mm	120 kg

EAN	5908252962891
-----	---------------

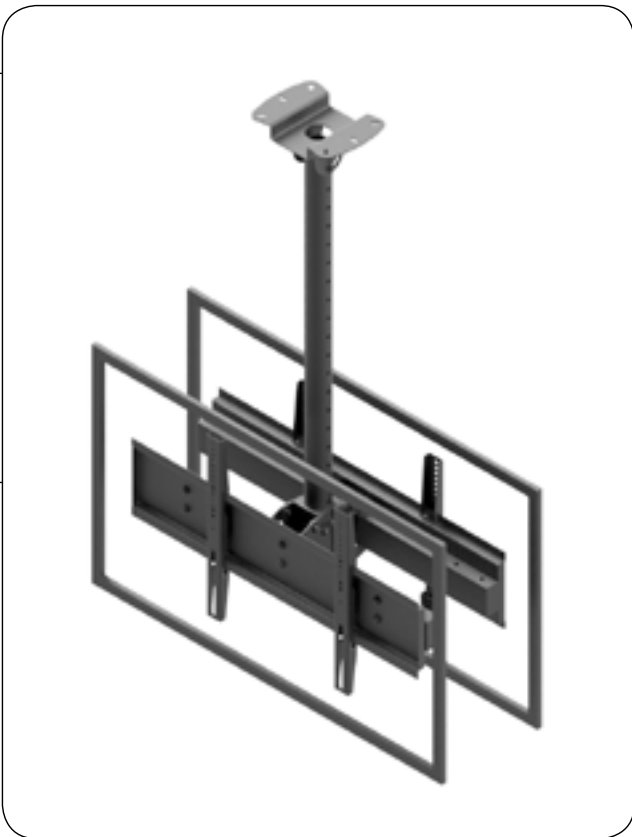



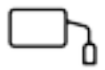

MENU BOARDS



FEATURES

- Universal range of Vesa mounting options
- Allows multiple installation of 6 screens
- Internal Cable management in pole
- Adjustable tilt angle from 0° to +18°
- Max. capacity 360 kg

TECHNICAL

				
min. 100x100 mm max. 600x400 mm	40"-55"	0°/+18°	min. 50x75 mm max. 400x260 mm	360 kg

EAN	5908252963201
-----	---------------

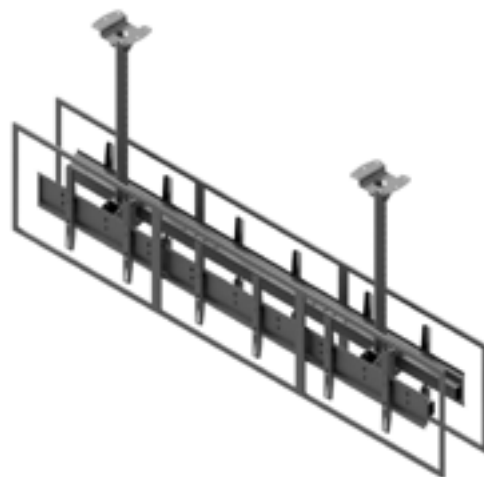





MENU BOARDS



FEATURES

- Universal range of Vesa mounting options
- Allows multiple installation of 4 screens
- Internal Cable management in pole
- Adjustable tilt angle from 0° to +18°
- Max. capacity 360 kg

TECHNICAL

				
min. 100x100 mm max. 600x400 mm	40"-55"	0°/+18°	min. 50x75 mm max. 400x260 mm	360 kg

EAN	5908252963218
-----	---------------

MENU BOARDS

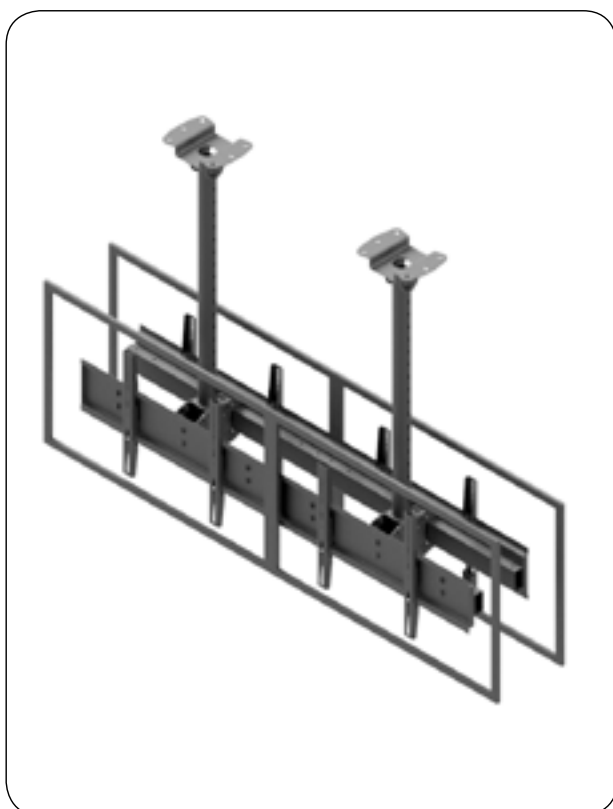





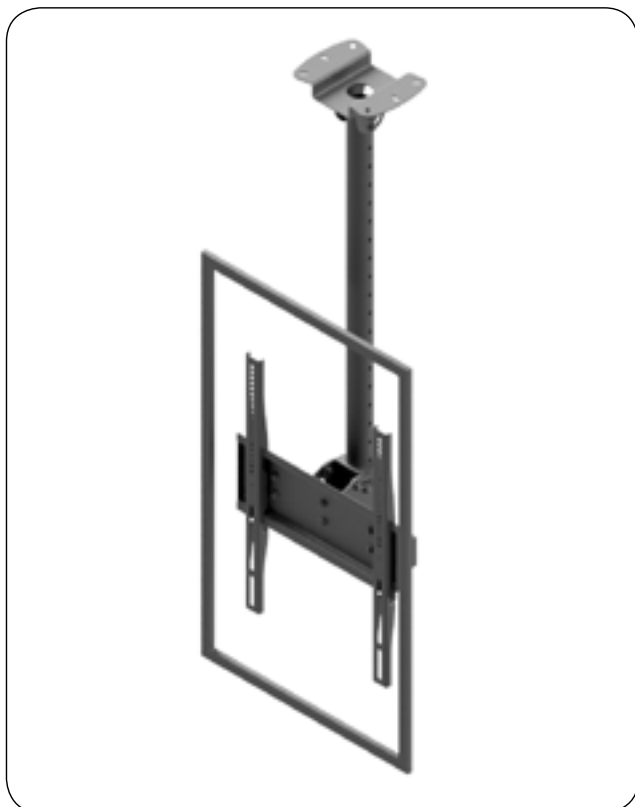

MENU BOARDS



FEATURES

- Universal range of Vesa mounting options
- Internal Cable management in pole
- Adjustable tilt angle from 0° to +18°
- Max. capacity 60 kg

TECHNICAL

				
min. 100x100 mm max. 600x400 mm	40"-55"	0°/+18°	min. 50x75 mm max. 400x260 mm	60 kg





EAN	5908252963225
-----	---------------



FEATURES

- Universal range of Vesa mounting options
- Allows multiple installation of 2 screens
- Internal Cable management in pole
- Adjustable tilt angle from 0° to +18°
- Max. capacity 120 kg

TECHNICAL

				
min. 100x100 mm max. 600x400 mm	40"-55"	0°/+18°	min. 50x75 mm max. 400x260 mm	120 kg

EAN	5908252963393
-----	---------------

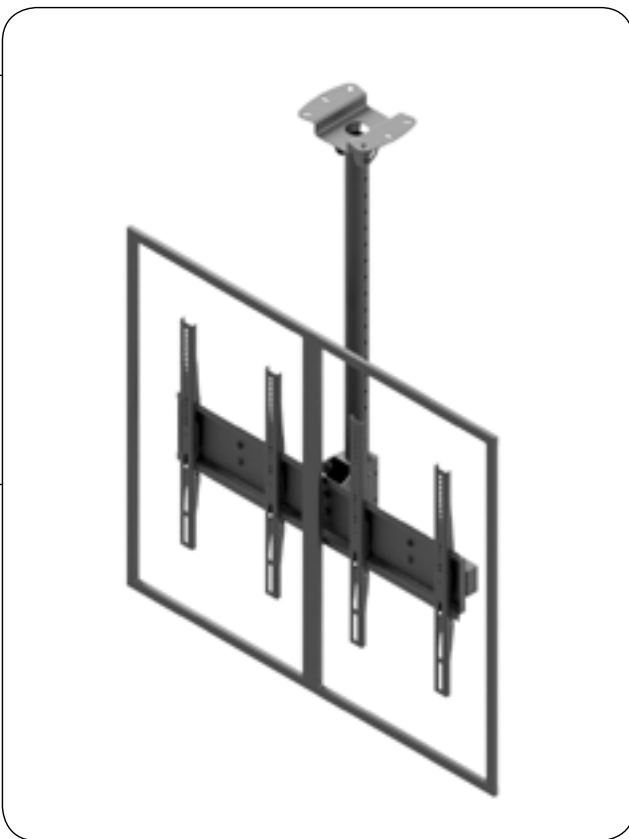

MENU BOARDS

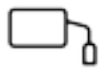

FEATURES

- Universal range of Vesa mounting options
- Allows multiple installation of 2 screens
- Internal Cable management in pole
- Adjustable tilt angle from 0° to +18°
- Max. capacity 120 kg

TECHNICAL

min. 100x100 mm max. 600x400 mm	40"-55"	0°/+18°	min. 50x75 mm max. 400x260 mm	120 kg

EAN	5908252963409
-----	---------------

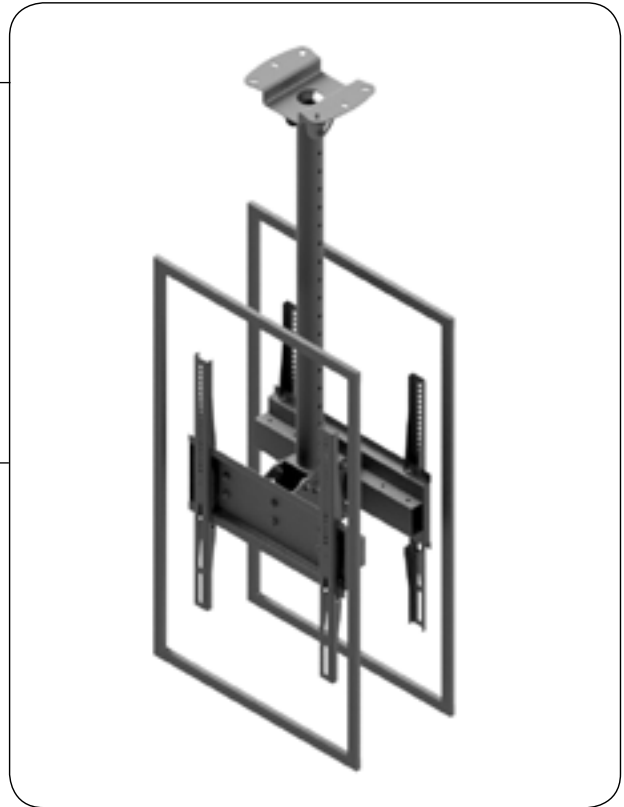

MENU BOARDS

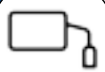

FEATURES

- Universal range of Vesa mounting options
- Allows multiple installation of 4 screens
- Internal Cable management in pole
- Adjustable tilt angle from 0° to +18°
- Max. capacity 240 kg

TECHNICAL

min. 100x100 mm max. 600x400 mm	40"-55"	0°/+18°	min. 50x75 mm max. 400x260 mm	240 kg

EAN	5908252963560
-----	---------------

MENU BOARDS

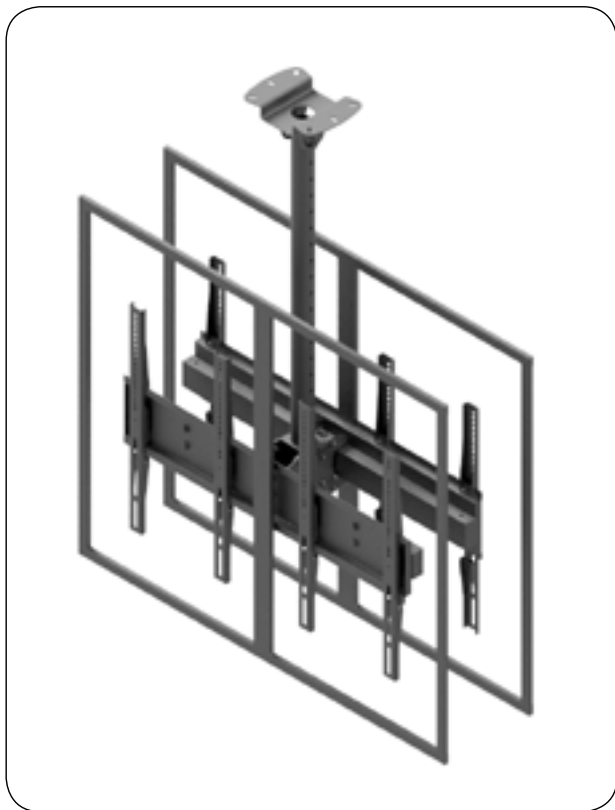

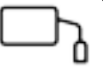



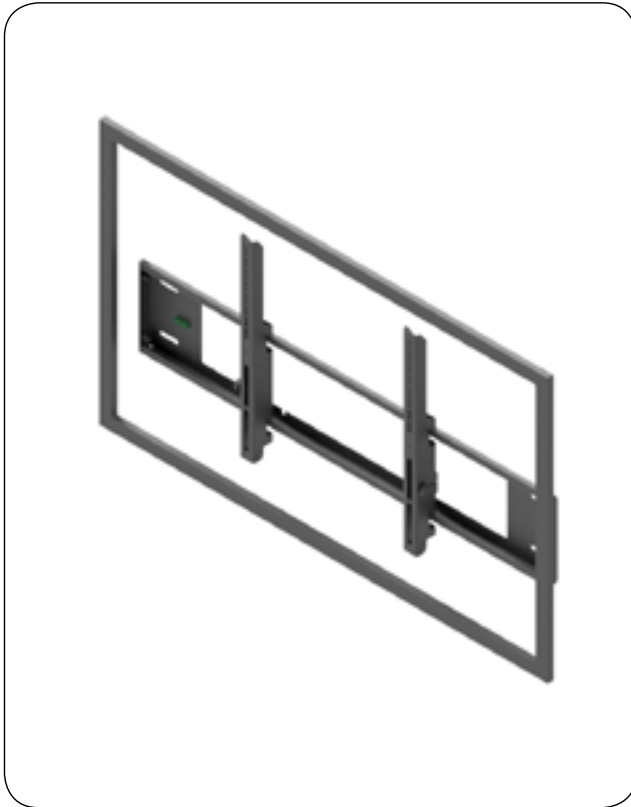

MENU BOARDS



FEATURES

- Universal range of Vesa mounting options
- Allows multiple installation
- Adjustable tilt angle from 0° to +18°
- Certificated for public use installation
- Heavy-duty design

TECHNICAL

				
min. 100x100 mm max. 600x400 mm	40"-55"	0°/+18°	min. 50x75 mm max. 400x260 mm	60 kg



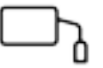

EAN	5908252963720
-----	---------------



FEATURES

- Universal range of Vesa mounting options
- Allows multiple installation of 3 screens
- Internal Cable management in pole
- Adjustable tilt angle from 0° to +18°
- Max. capacity 180 kg

TECHNICAL

				
min. 100x100 mm max. 600x400 mm	40"-55"	0°/+18°	min. 50x75 mm max. 400x260 mm	180 kg

EAN	5908252963690
-----	---------------

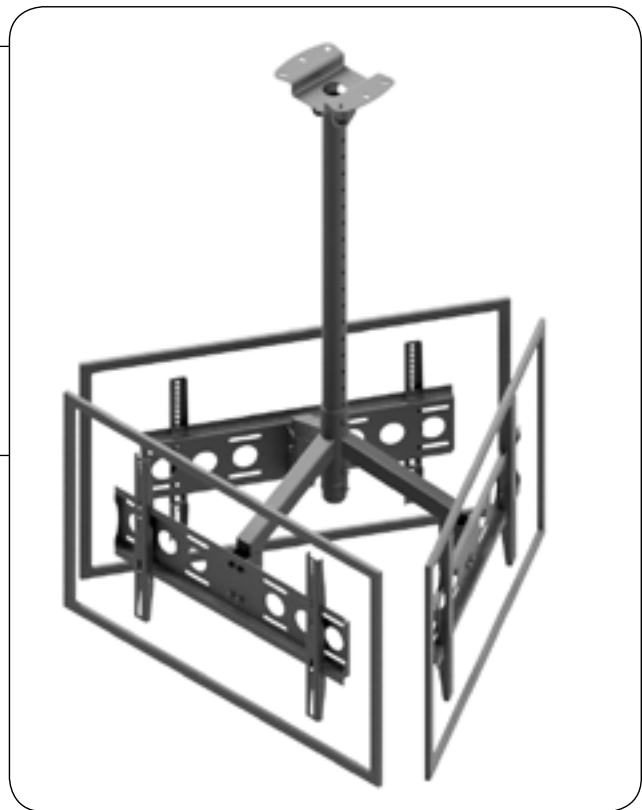

MENU BOARDS

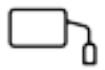

FEATURES

- Universal range of Vesa mounting options
- Allows multiple installation of 4 screens
- Internal Cable management in pole
- Adjustable tilt angle from 0° to +18°
- Max. capacity 240 kg

TECHNICAL



min.
100x100 mm
max.
600x400 mm



40"-47"



0°/+18°



min.
50x75 mm
max.
400x260 mm



240 kg

EAN

5908252963706

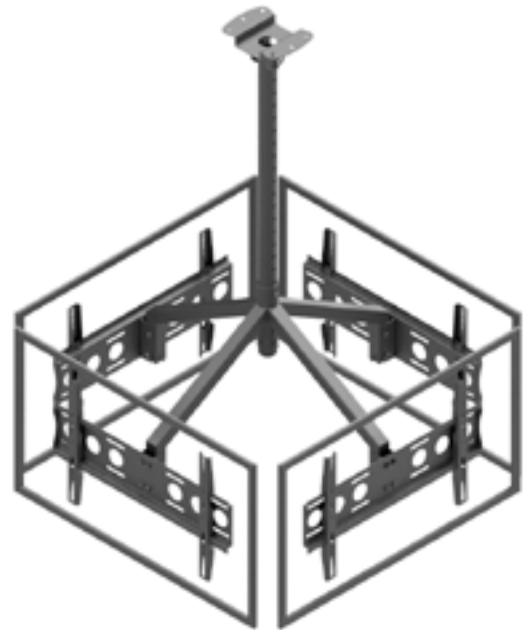

MENU BOARDS

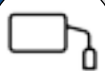

FEATURES

- Universal range of Vesa mounting options
- Allows multiple installation of 4 screens
- Internal Cable management in pole
- Adjustable tilt angle from 0° to +18°
- Max. capacity 240 kg

TECHNICAL



min.
100x100 mm
max.
600x400 mm



40"-55"



0°/+18°



min.
50x75 mm
max.
400x260 mm



240 kg

EAN

5908252963713



MENU BOARDS



MONITOR MOUNTS

FEATURES

Full range options – including desk, wall and ceiling designs

Ergonomic – space saving solutions with ergonomic features

Vesa – compatibility with monitors from 75x75 to 200x200

Adjustment – Fully adjustable including height, tilt and swivel



19"-27" LCD Fixed Wall Mount

GD22

FEATURES

- Slim profile for minimum distance from the wall
- Heavy duty 3mm professional gauge steel
- Easy and simple installation in just 3 steps

TECHNICAL

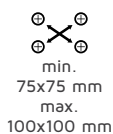

WALL MONITOR MOUNTS

PRODUCT SPECIFICATION

Dimensions	Weight	Max capacity	Colour	Packaging dimensions	EAN
201,5x150x18 mm	1 kg	10 kg	black grey	160x225x20 mm	5908252961177 5908252961184



19"-27" LCD Swing Arm Wall Mount

GD01

WALL MONITOR MOUNTS



FEATURES

- Increased flexibility of 2 axis of rotation
- 360° rotation for portrait or horizontal screen option
- Under arm cable management

TECHNICAL

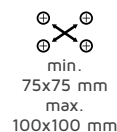

PRODUCT SPECIFICATION

Dimensions	Weight	Max capacity	Colour	Packaging dimensions	EAN
783x800x500 mm	9,3 kg	80 kg	black silver	810x280x950 mm	5908252968060 5908252968794



WALL MONITOR MOUNTS



FEATURES

- Increased flexibility of 2 axis of rotation
- 360° rotation for portrait or horizontal screen option
- Under arm cable management

TECHNICAL



min.
75x75 mm
max.
100x100 mm

19"-27"

10 kg

110°/110°

min.
75x75 mm
max.
100x100 mm



min. 108 mm
max. 307 mm

180°

360°

PRODUCT SPECIFICATION

Dimensions	Weight	Max capacity	Colour	Packaging dimensions	EAN
307x178x115 mm	2.5 kg	10 kg	black grey	425x250x100 mm	5908252960309 5908252960316



FEATURES

- Slim profile for minimum distance from the wall
- 360° rotation for portrait or horizontal screen option
- Easy and simple installation in just 3 steps

TECHNICAL



min.
75x75 mm
max.
100x100 mm

19"-27"

10 kg

360°

min.
75x75 mm
max.
100x100 mm



25 mm



WALL MONITOR MOUNTS

PRODUCT SPECIFICATION

Dimensions	Weight	Max capacity	Colour	Packaging dimensions	EAN
115x115x25 mm	0.55 kg	10 kg	black grey	135x135x55 mm	5908252960323 5908252960330



FEATURES

- 360° rotation for portrait or horizontal screen option
- Adjustable Tilt Angles included from 180°
- Includes security screw-theft-protection
- Easy and simple installation in just 3 steps

PRODUCT SPECIFICATION

Dimensions	Weight	Max capacity	Colour	Packaging dimensions	EAN
115x115x106 mm	0.8 kg	10 kg	black grey	115x120x120 mm	5908252960347 5908252960354

TECHNICAL



min. 75x75 mm
max. 100x100 mm



110°/110°



19"-27"



180°



MAX KG
10 kg



360°



106 mm



min. 75x75 mm
max. 100x100 mm



WALL MONITOR MOUNTS



FEATURES

- Slim profile for minimum distance from the wall
- 360° rotation for portrait or horizontal screen option
- Easy and simple installation in just 2 steps

TECHNICAL



min.
75x75 mm
max.
100x100 mm



19"-27"



10 kg



110°/110°



min.
75x75 mm
max.
100x100 mm



124 mm



140°



360°

PRODUCT SPECIFICATION

Dimensions	Weight	Max capacity	Colour	Packaging dimensions	EAN
174x126x124 mm	1.1 kg	10 kg	black grey	200x140x140 mm	5908252961191 5908252961207



FEATURES

- 360° rotation for portrait or horizontal screen option
- Adjustable Tilt Angles included from 145°
- Easy and simple installation in just 2 steps

TECHNICAL



min.
75x75 mm
max.
100x100 mm



19"-27"



10 kg



110°/110°



min.
75x75 mm
max.
100x100 mm



91 mm



145°



360°



WALL MONITOR MOUNTS

PRODUCT SPECIFICATION

Dimensions	Weight	Max capacity	Colour	Packaging dimensions	EAN
115x115x91 mm	1.1 kg	10 kg	black grey	200x140x140 mm	5908252961214 5908252961221



19"-27" LCD Swing Arm Wall Mount

GD25

FEATURES

- Adjustable wall extension from 108 to 305 mm
- Increased flexibility of 2 axis of rotation
- 360° rotation for portrait or horizontal screen option
- Easy and simple installation in just 2 steps

TECHNICAL

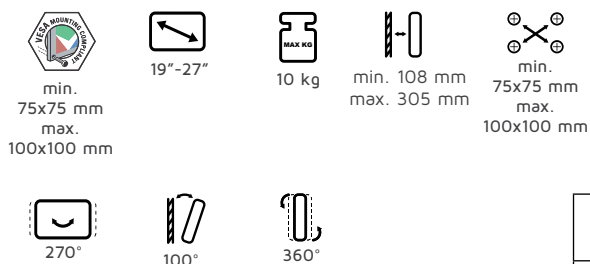

WALL MONITOR MOUNTS

PRODUCT SPECIFICATION

Dimensions	Weight	Max capacity	Colour	Packaging dimensions	EAN
305x159x125 mm	1.5 kg	10 kg	black grey	330x170x100 mm	5908252962556 5908252961443



19"-27" LCD Swing Arm Wall Mount

GD26

WALL MONITOR MOUNTS



FEATURES

- Adjustable wall extension from 108 to 600 mm
- Increased flexibility of 3 axis of rotation
- 360° rotation for portrait or horizontal screen option
- Under arm cable management

TECHNICAL

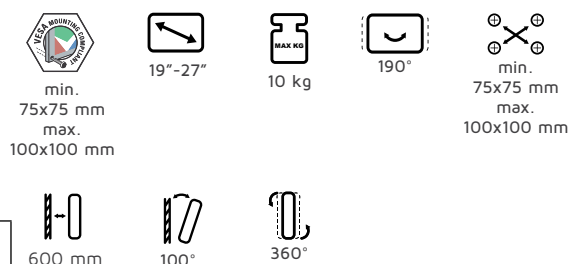

PRODUCT SPECIFICATION

Dimensions	Weight	Max capacity	Colour	Packaging dimensions	EAN
600x238x147 mm	3.7 kg	10 kg	black grey	425x250x100 mm	5908252961450 5908252961467



WALL MONITOR MOUNTS



FEATURES

- 360° rotation for portrait or horizontal screen option
- Adjustable arm length - from 52 to 460 mm
- Professional gas spring loaded for widest range of adjustment
- Easy and simple installation in just 2 steps

TECHNICAL



min.
75x75 mm
max.
100x100 mm

19"-27"

10 kg

90°/90°

min.
75x75 mm
max.
100x100 mm



min. 52 mm
max. 460 mm



90°/90°



360°

PRODUCT SPECIFICATION

Dimensions	Weight	Max capacity	Colour	Packaging dimensions	EAN
460x551x52 mm	4 kg	10 kg	black grey	760x320x130 mm	5908252963898 5908252963904



FEATURES

- 360° rotation for portrait or horizontal screen option
- Adjustable arm length - from 52 to 684 mm
- Professional gas spring loaded for widest range of adjustment
- Easy and simple installation in just 2 steps

TECHNICAL



min.
75x75 mm
max.
100x100 mm

19"-27"

10 kg

90°/90°

min.
75x75 mm
max.
100x100 mm



min. 52 mm
max. 684 mm



90°/90°



360°



WALL MONITOR MOUNTS

PRODUCT SPECIFICATION

Dimensions	Weight	Max capacity	Colour	Packaging dimensions	EAN
684x538x52 mm	4.9 kg	10 kg	black grey	650x520x130 mm	5908252963911 5908252963928



19"-27" LCD Wall Mount with gas spring

MWM131

FEATURES

- Adjustable arm length - from 52 to 908 mm
- Increased flexibility via 3 axis of rotation
- 360° rotation for portrait or horizontal screen option
- Professional gas spring loaded for widest range of adjustment

TECHNICAL

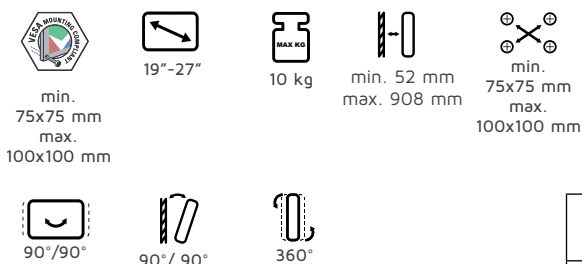

WALL MONITOR MOUNTS

PRODUCT SPECIFICATION

Dimensions	Weight	Max capacity	Colour	Packaging dimensions	EAN
908x615x52 mm	5.9 kg	10 kg	black grey	650x540x130 mm	5908252963935 5908252963942



19"-27" LCD Wall Mount with gas spring

MWM221

WALL MONITOR MOUNTS



FEATURES

- Flexible option of mounting 2 screens
- Adjustable arm length - from 52 to 532 mm
- Professional gas spring loaded for widest range of adjustment
- 360° rotation for portrait or horizontal screen option

TECHNICAL

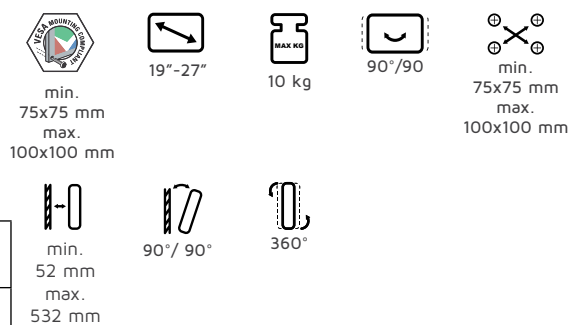

PRODUCT SPECIFICATION

Dimensions	Weight	Max capacity	Colour	Packaging dimensions	EAN
1064x715x52 mm	7.5 kg	10 kg	black grey	650x520x130 mm	5908252963959 5908252963966



WALL MONITOR MOUNTS



FEATURES

- 360° rotation for portrait or horizontal screen option
- Adjustable arm length- from 158 to 310 mm
- Increased flexibility of 2 axis of rotation
- Easy and simple installation in just 2 steps

TECHNICAL

min. 75x75 mm
max. 100x100 mm

90° / 90° 360°

PRODUCT SPECIFICATION

Dimensions	Weight	Max capacity	Colour	Packaging dimensions	EAN
310x70x70 mm	2 kg	10 kg	black grey	420x170x140 mm	5908252960361 5908252960378



FEATURES

- 360° rotation for portrait or horizontal screen option
- Complete vertical and horizontal adjustability
- Allows dual mounting options: through desk OR edge of desk
- Easy and simple installation in just 2 steps

TECHNICAL

min. 75x75 mm
max. 100x100 mm

250° 360°

DESK MONITOR MOUNTS



PRODUCT SPECIFICATION

Dimensions	Weight	Max capacity	Colour	Packaging dimensions	EAN
405x125x116 mm	3.3 kg	10 kg	black grey	520x170x130 mm	5908252960408 5908252960415



19"-27" LCD Desk Mount with gas spring

SV02

FEATURES

- Professional gas spring loaded for widest range of adjustment
- 360° rotation for portrait or horizontal screen option
- Adjustable arm length- from 67 to 396 mm
- Easy and simple installation in just 2 steps

TECHNICAL

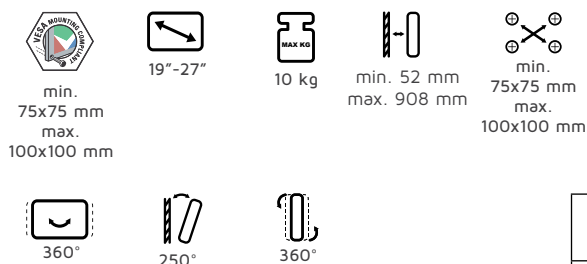

DESK MONITOR MOUNTS

PRODUCT SPECIFICATION

Dimensions	Weight	Max capacity	Colour	Packaging dimensions	EAN
405x125x366 mm	4.1 kg	10 kg	black grey	530x180x130 mm	5908252960460 5908252960477



19"-27" LCD Desk Mount

SV03

DESK MONITOR MOUNTS



FEATURES

- Adjustable arm length - from 10 to 700 mm
- 360° rotation for portrait or horizontal screen option
- Complete vertical and horizontal adjustability
- Allows dual mounting options: through desk or edge of desk

TECHNICAL



PRODUCT SPECIFICATION

Dimensions	Weight	Max capacity	Colour	Packaging dimensions	EAN
405x125x700 mm	4.9 kg	10 kg	black grey	480x375x130 mm	5908252960484 5908252960491



FEATURES

- Adjustable wall extension from 108 to 792 mm
- Increased flexibility of 3 axis of rotation
- 360° rotation for portrait or horizontal screen option
- Under arm cable management



PRODUCT SPECIFICATION

Dimensions	Weight	Max capacity	Colour	Packaging dimensions	EAN
792x219x115 mm	2.5 kg	10 kg	black grey	425x250x100 mm	5908252968060 5908252968794

TECHNICAL



min.
75x75
max.
100x100
mm



19"-27"



10 kg



110°/110°



min. 108
mm
max. 792
mm



180°



360°



min.
75x75 mm
max.
100x100 mm



19"-27" LCD Slim Pole Desk Mount

SV29

FEATURES

- Distance from desk to the screen 530 mm to 875 mm
- Adjustable Tilt Angle included from 90° to 30° degrees.
- Allows dual mounting options: through desk or edge of desk

TECHNICAL



min.
75x75 mm
max.
100x100 mm



19"-27"



10 kg



360°



min.
75x75 mm
max.
100x100 mm



90°/-30°



DESK MONITOR MOUNTS

PRODUCT SPECIFICATION

Dimensions	Weight	Max capacity	Colour	Packaging dimensions	EAN	Index
875x125x45 mm	2.2 kg	10 kg	black grey	540x130x120 mm	5908252962082 5908252962105 5908252962112 5908252962136	SV29Ac-B SV29Cc-B SV29As-B SV29Cs-B



19"-27" LCD Slim Pole Desk Mount

SV30

DESK MONITOR MOUNTS



FEATURES

- Distance from desk to the screen 280 mm to 480 mm
- Adjustable Tilt Angle included from 90° to 30° degrees.
- Allows dual mounting options: through desk or edge of desk

TECHNICAL



min.
75x75 mm
max.
100x100 mm



19"-27"



10 kg



360°



min.
75x75 mm
max.
100x100 mm



90°/-30°

PRODUCT SPECIFICATION

Dimensions	Weight	Max capacity	Colour	Packaging dimensions	EAN	Index
405x125x366 mm	2 kg	10 kg	black grey	340x130x120 mm	5908252961092 5908252962051 5908252962075 5908252962044	SV30Ac-B SV30Cc-B SV30As-B SV30Cs-B



DESK MONITOR MOUNTS



FEATURES

- Flexible option of mounting 2 screens
- 360° rotation for portrait or horizontal screen option
- Allows dual mounting options: through desk or edge of desk
- Easy and simple installation in just 2 steps

TECHNICAL

min. 75x75 mm
max. 100x100 mm

19"-27"

20 kg

360°

min. 75x75 mm
max. 100x100 mm

160°

360°

PRODUCT SPECIFICATION

Dimensions	Weight	Max capacity	Colour	Packaging dimensions	EAN
405x750x107 mm	4.9 kg	20 kg	black grey	650x210x160 mm	5908252960521 5908252960538



FEATURES

- Flexible option of mounting 4 screens
- Complete vertical and horizontal adjustability
- Allows dual mounting options: through desk OR edge of desk
- Easy and simple installation in just 2 steps

TECHNICAL

min. 75x75 mm
max. 100x100 mm

19"-27"

40 kg

360°

min. 75x75 mm
max. 100x100 mm

160°

360°

PRODUCT SPECIFICATION

Dimensions	Weight	Max capacity	Colour	Packaging dimensions	EAN
705x7500x107 mm	7.5 kg	40 kg	black grey	820x190x120 mm	5908252960545 5908252960552

DESK MONITOR MOUNTS





19"-27" Dual LCD Desk Mount

SV08

FEATURES

- 360° rotation for portrait or horizontal screen option
- Complete vertical and horizontal adjustability
- Allows dual mounting options: through desk or edge of desk
- Easy and simple installation in just 2 steps

TECHNICAL

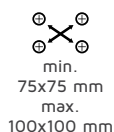

DESK MONITOR MOUNTS

PRODUCT SPECIFICATION

Dimensions	Weight	Max capacity	Colour	Packaging dimensions	EAN
705x125x116 mm	4.9 kg	20 kg	black grey	820x190x120 mm	5908252960569 5908252960576



19"-27" Triple LCD Desk Mount

SV09

DESK MONITOR MOUNTS

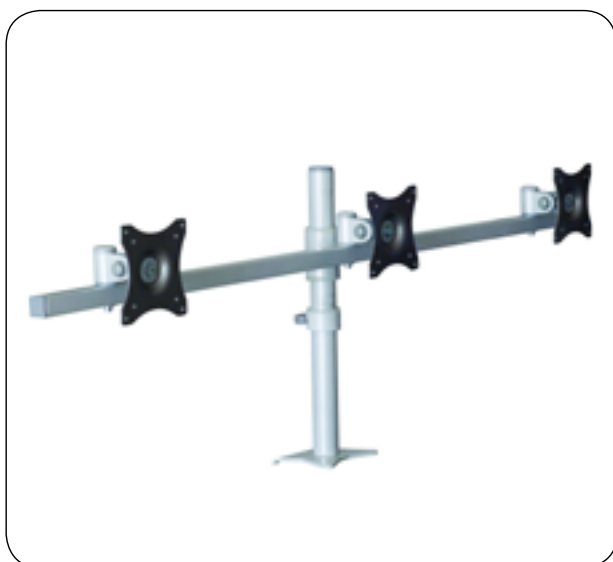

FEATURES

- Flexible option for mounting 3 screens
- 360° rotation for portrait or horizontal screen option
- Complete vertical and horizontal adjustability
- Allows dual mounting options: through desk or edge of desk

TECHNICAL

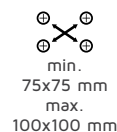

PRODUCT SPECIFICATION

Dimensions	Weight	Max capacity	Colour	Packaging dimensions	EAN
405x1200x120 mm	6.9 kg	30 kg	black grey	1300x210x170 mm	5908252960583 5908252960590



DESK MONITOR MOUNTS



FEATURES

- Flexible option for mounting 3 screens
- 360° rotation for portrait or horizontal screen option
- Complete vertical and horizontal adjustability
- Allows dual mounting options: through desk or edge of desk

TECHNICAL

min. 75x75 mm
max. 100x100 mm

19"-27"

MAX KG
30 kg

360°

min. 75x75 mm
max. 100x100 mm

160°

360°

PRODUCT SPECIFICATION

Dimensions	Weight	Max capacity	Colour	Packaging dimensions	EAN
405x1400x108 mm	9.7 kg	30 kg	black grey	1450x210x170 mm	5908252960606 5908252960613



FEATURES

- Flexible option for mounting 3 screens
- Allows Parabolic layout of displays for Ergonomic solution
- Complete vertical and horizontal adjustability
- Allows dual mounting options: through desk or edge of desk

TECHNICAL

min. 75x75 mm
max. 100x100 mm

19"-27"

MAX KG
30 kg

210°

min. 75x75 mm
max. 100x100 mm

160°

360°



DESK MONITOR MOUNTS

PRODUCT SPECIFICATION

Dimensions	Weight	Max capacity	Colour	Packaging dimensions	EAN
405x1490x108 mm	10.5 kg	30 kg	black grey	1520x210x170 mm	5908252960620 5908252960637



FEATURES

- Adjustable arm length - from 10 to 528 mm
- 360° rotation for portrait or horizontal screen option
- Complete vertical and horizontal adjustability
- Allows dual mounting options: through desk or edge of desk

PRODUCT SPECIFICATION

Dimensions	Weight	Max capacity	Colour	Packaging dimensions	EAN
405x125x528 mm	4.4 kg	10 kg	black grey	520x170x130 mm	5908252960507 5908252960514

TECHNICAL



min.
75x75
max.
100x100
mm



19"-27"



250°



10 kg



360°



90°/90°



min.
75x75 mm
max.
100x100 mm

100x100 mm



DESK MONITOR MOUNTS



FEATURES

- Flexible option of mounting 2 screens
- 360° rotation for portrait or horizontal screen option
- Allows dual mounting options: through desk or edge of desk
- Easy and simple installation in just 2 steps

TECHNICAL

min. 75x75 mm
max. 100x100 mm

19"-27"

30 kg

360°

min. 75x75 mm
max. 100x100 mm

90°/ 90°

360°

PRODUCT SPECIFICATION

Dimensions	Weight	Max capacity	Colour	Packaging dimensions	EAN
405x700x700 mm	10 kg	10 kg	black silver	750x350x180 mm	5908252961849



FEATURES

- 360° rotation for portrait or horizontal screen option
- Adjustable arm length - from 52 to 684 mm
- Professional gas spring loaded for widest range of adjustment
- Easy and simple installation in just 2 steps

TECHNICAL

min. 75x75 mm
max. 100x100 mm

19"-27"

10 kg

90°/ 90°

min. 75x75 mm
max. 100x100 mm

90°/ 90°

360°



DESK MONITOR MOUNTS

PRODUCT SPECIFICATION

Dimensions	Weight	Max capacity	Colour	Packaging dimensions	EAN
684x636x119 mm	6 kg	20 kg	black grey	650x520x130 mm	5908252964017 5908252964024



19"-27" Hexa-LCD Desk Mount

SV16

FEATURES

- Flexible option of mounting 6 screens
- Under arm cable management
- Complete vertical and horizontal adjustability
- Allows dual mounting options: through desk or edge of desk

TECHNICAL

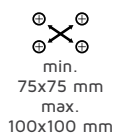

DESK MONITOR MOUNTS

PRODUCT SPECIFICATION

Dimensions	Weight	Max capacity	Colour	Packaging dimensions	EAN
705x1400x108 mm	14.5 kg	60 kg	black grey	1300x210x170 mm	5908252960729 5908252960736



19"-27" Hexa-LCD Desk Mount

SV17

DESK MONITOR MOUNTS



FEATURES

- Flexible option of mounting 6 screens
- Allows Parabolic layout of displays for Ergonomic solution
- Complete vertical and horizontal adjustability
- Allows dual mounting options: through desk or edge of desk

TECHNICAL

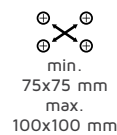

PRODUCT SPECIFICATION

Dimensions	Weight	Max capacity	Colour	Packaging dimensions	EAN
705x1490x108 mm	14.5 kg	60 kg	black grey	1300x330x220 mm	5908252960743 5908252960750



FEATURES

- Flexible option of mounting 2 screens
- Adjustable arm length - from 10 to 525 mm
- Allows dual mounting options: through desk OR edge of desk
- Easy and simple installation in just 2 steps

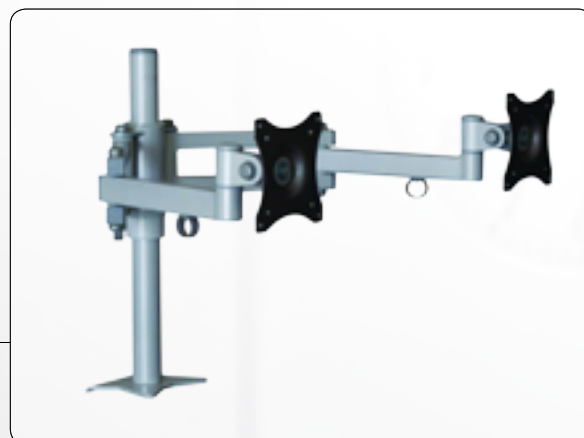

PRODUCT SPECIFICATION

Dimensions	Weight	Max capacity	Colour	Packaging dimensions	EAN
405x1050x107 mm	6.8 kg	20 kg	black grey	560x220x140 mm	5908252961603 5908252961610

TECHNICAL

75x75
100x100
mm
 19"-27"
 20 kg
 360°
 150°
 min.
75x75 mm
max.
100x100 mm



19"-27" Dual LCD Swing Arm Desk Mount with gas spring

MDM221

FEATURES

- Flexible option of mounting 2 screens
- Adjustable arm length - from 52 to 532 mm
- Professional gas spring loaded for widest range of adjustment
- 360° rotation for portrait or horizontal screen option

TECHNICAL

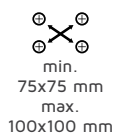

MONITOR MOUNTS

PRODUCT SPECIFICATION

Dimensions	Weight	Max capacity	Colour	Packaging dimensions	EAN
636x1064x119 mm	10.5 kg	20 kg	black grey	1060x630x200 mm	5908252964031 5908252964048



19"-27" Swing Arm Wall Mount

MSA02

MEDICAL MONITOR MOUNTS



FEATURES

- Distance from the wall to screen up to 1610 mm
- Professional gas spring loaded for smooth vertical adjustment
- Increased flexibility of 3 axis of rotation
- 360° rotation for portrait or horizontal screen option
- Full cable management

TECHNICAL

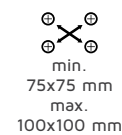

PRODUCT SPECIFICATION

Dimensions	Weight	Max capacity	Colour	Packaging dimensions	EAN
1610x884x160 mm	12 kg	10 kg	black silver white	1080x650x220 mm	5908252962563 5908252962587 5908252962570



UNDERSHELF MONITOR MOUNTS



FEATURES

- Optional under shelf assembly
- Adjustable tilt angle from 12° to 90°
- 360° rotation for portrait or horizontal screen option
- Easy and simple installation in just 2 steps

TECHNICAL



19"-27"



10 kg



299 mm



min.
75x75 mm
max.
100x100 mm

min.
75x75 mm
max.
100x100 mm



12° / 90°



360°

PRODUCT SPECIFICATION

Dimensions	Weight	Max capacity	Colour	Packaging dimensions	EAN
1610x884x160 mm	12 kg	10 kg	black silver white	1080x650x220 mm	5908252962563 5908252962587 5908252962570



FEATURES

- Distance from the ceiling to the screen up to 730 mm
- 360° full Horizontal adjustment
- Adjustable tilt angle 120°
- Max. capacity 10 kg

TECHNICAL



min.
75x75 mm
max.
100x100 mm



19"-27"



10 kg



180°



min.
75x75 mm
max.
100x100 mm



120°



360°



730 mm



CEILING MONITOR MOUNTS

PRODUCT SPECIFICATION

Dimensions	Weight	Max capacity	Colour	Packaging dimensions	EAN
730x119x135 mm	3.2 kg	10 kg	black grey	820x190x120 mm	5908252960934 5908252960941



19"-27" LCD Adjustable Ceiling Mount

SV34

FEATURES

- Telescopic mounting - with flexible height adjustment
- Adjustable tilt angle 120°
- 360° full Horizontal adjustment
- Max. capacity 10 kg
- Full cable management

TECHNICAL

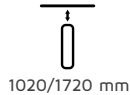
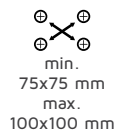

CEILING MONITOR MOUNTS

PRODUCT SPECIFICATION

Dimensions	Weight	Max capacity	Colour	Packaging dimensions	EAN
1720x119x145 mm	6.5 kg	10 kg	black grey	1000x200x160 mm	5908252961627 5908252961634



19"-27" Dual LCD Ceiling Mount

SV35

CEILING MONITOR MOUNTS



FEATURES

- Telescopic mounting - with flexible height adjustment
- Adjustable tilt angle 120°
- 360° full Horizontal adjustment
- Max. capacity 10 kg

TECHNICAL

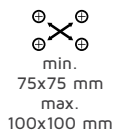

PRODUCT SPECIFICATION

Dimensions	Weight	Max capacity	Colour	Packaging dimensions	EAN
1720x119x145 mm	6.7 kg	20 kg	black grey	1000x200x160 mm	5908252961856 5908252961863

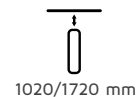



FEATURES

- Distance from the ceiling to screen 1593 mm to 2545 mm
- Professional gas spring loaded for smooth vertical adjustment
- Increased flexibility of 3 axis of rotation
- 360° rotation for portrait or horizontal screen option
- Full cable management

PRODUCT SPECIFICATION

Dimensions	Weight	Max capacity	Colour	Packaging dimensions	EAN
1744x2545x2490 mm	23 kg	10 kg	black grey white	1050x620x350 mm	5908252962365 5908252962372 5908252962341

TECHNICAL



min.
75x75
max.
100x100
mm



19"-27"



10 kg



360°



min.
75x75 mm
max.
100x100 mm



22,5/-22,5°



360°



GDA01 VESA Adapter Plate 200x100

Colour	Packaging dimensions	EAN
black grey white	230x125x20 mm	5908252962181 5908252960293 5908252963478



GDA02 VESA Adapter Plate 200x200

Colour	Packaging dimensions	EAN
black grey white	225x225x20 mm	5908252962198 5908252961498 5908252963461



SVA01 Free Standing LCD Base Plate for SV Series

Colour	Packaging dimensions	EAN
black grey	480x400x70 mm	5908252961887 5908252961139



SVA02 Free Standing LCD Base Plate for SV Series

Colour	Packaging dimensions	EAN
black silver	1800x360x140 mm	5908252961122 5908252962389



CSV1 Split clamp for SV Series

Colour	Packaging dimensions	EAN
black	140x140x120 mm	5908252961887



GU81 PC Mount

Colour	Packaging dimensions	EAN
black silver	315x170x80 mm	5908252961276 5908252961283





TABLETS

FEATURES

One box - ready to use solution including mount, universal tablet bracket and accessories

Universal - complete range including iPad and universal brackets for key manufacturers

Modern Design - Slim mount casing with rounded corners for sleek look and feel

Security - lockable options featuring security screws for safety in public areas



Tablet Mount

IPM01

FEATURES

- Flexible mounting options
- Includes security screw theft-protection
- Low profile design
- Easy and simple installation in just 3 steps



TABLET ENCLOSURES

PRODUCT SPECIFICATION

Dimensions	Weight	Max capacity	Colour	Packaging dimensions	EAN
270x250x30 mm	0,8 kg	5 kg	black silver	290x270x50 mm	5908252964635 5908252964642 5908252964659



Indoor tablet enclosure - 10"

ITE1001

TABLET ENCLOSURES



FEATURES

- Flexible mounting options
- Includes anti-theft system
- Customization options
- Low profile design
- Easy and simple installation in just 3 steps
- Full cable management

PRODUCT SPECIFICATION

Dimensions	Weight	Max capacity	Colour	Packaging dimensions	EAN
275x202x34 mm	1 kg	-	RAL palette	300x210x40 mm	5908252967834



ENCLOSURES



FEATURES

- Flexible mounting options
- Includes anti-theft system
- Customization options
- Low profile design
- Easy and simple installation in just 3 steps

PRODUCT SPECIFICATION

Dimensions	Weight	Max capacity	Colour	Packaging dimensions
200x300x280 mm	7 kg	3 kg	black	300x400x380 mm



FEATURES

- Flexible mounting options
- Includes anti-theft system
- Customization options
- Low profile design
- Easy and simple installation in just 3 steps

ENCLOSURES

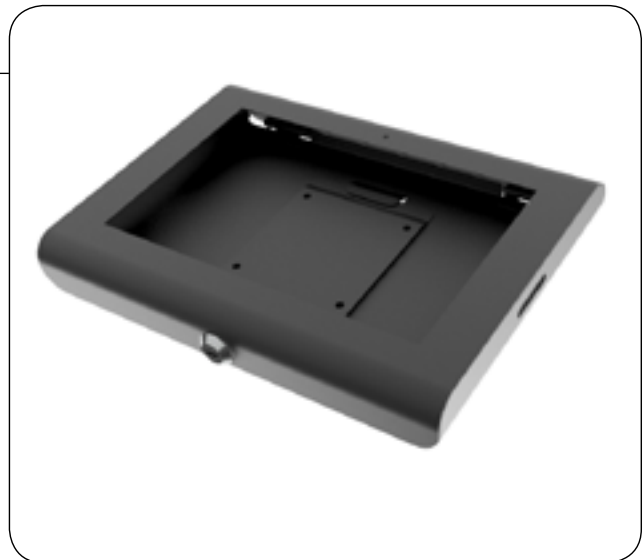

PRODUCT SPECIFICATION

Dimensions	Weight	Max capacity	Colour	Packaging dimensions
custom	4 kg	10 kg	black	custom



ITSV Series Tablet Stands with VESA Adapter

ITSV01

FEATURES

- Universal range of Vesa mounts and adapter included
- Adjustable tilt angle from 0° to 45°
- Heavy stable base with optional mounting direct to floor
- Full Internal Cable management
- Tubular chrome pole luxury finish

TECHNICAL



min. 75x75
max. 100x100
mm



45°



5 kg



STANDS

PRODUCT SPECIFICATION

Dimensions	Weight	Max capacity	Colour	Packaging dimensions	EAN
300x300x1090 mm	9 kg	5 kg	black	400x400x1190 mm	5908252964741



ITSV Series Tablet Stands with VESA Adapter

STANDS



FEATURES

- Universal range of Vesa mounts and adapter included
- Full Internal Cable management
- Heavy stable base
- Adjustable tilt angle
- Customization options

FEATURES PHOTO



PRODUCT	IMAGE	ADJUSTMENT RANGE	MAX. CAPACITY	VESA	WEIGHT	DIMENSIONS
ITSV02		29°/44°	5 kg	75x75 mm	15 kg	350x350x1030 mm
ITSV02L		29°/44°	5 kg	75x75 mm	15 kg	350x350x1030 mm



STANDS



FEATURES

- Solid steel design
- Full Internal Cable management
- Heavy stable base
- Adjustable tilt angle
- Customization options

FEATURES PHOTO

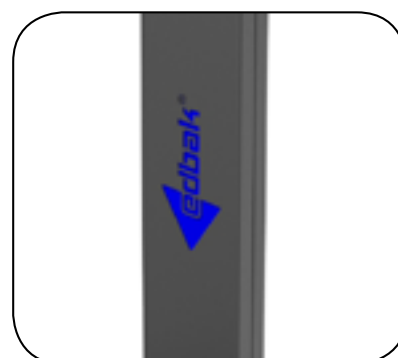

PRODUCT	IMAGE	ADJUSTMENT RANGE	MAX. CAPACITY	VESA	WEIGHT	DIMENSIONS
ITSV03		29°/44°	8 kg	min. 75x75 max. 100x100	19 kg	400x450x1030 mm
ITSV03L		29°/44°	8 kg	min. 75x75 max. 100x100	19 kg	400x450x1030 mm
ITSV03P		29°/44°	8 kg	min. 75x75 max. 100x100	19 kg	400x450x1030 mm



ITS Series Tablet Stands with Enclosure

FEATURES

- Full Internal Cable management
- Heavy stable base
- Adjustable tilt angle
- Includes anti-theft system
- Customization options

FEATURES PHOTO

NEW PRODUCT

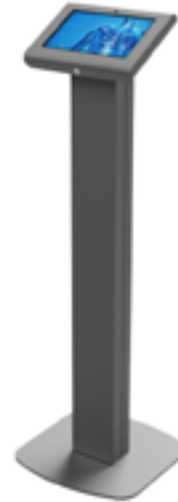

STANDS

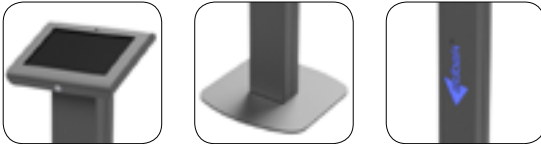

PRODUCT	IMAGE	ADJUSTMENT RANGE	MAX. CAPACITY	VESA	WEIGHT	DIMENSIONS
ITS02		29°/44°	5 kg	75x75	18 kg	350x350x1090 mm
ITS02L		29°/44°	5 kg	75x75	18 kg	350x350x1090 mm



ITS Series Tablet Stands with Enclosure

ITS04

STANDS



FEATURES

- Universal range of Vesa mounts and adapter included
- Adjustable tilt angle from 0° to 45°
- Heavy stable base with optional mounting direct to floor
- Full Internal Cable management
- Flexible mounting options

TECHNICAL



75x75
100x100
mm



3 kg



min.
75x75 mm
max.
100x100 mm



+90°/-90°



0°/90°

PRODUCT SPECIFICATION

Dimensions	Weight	Max capacity	Colors	Packaging dimensions	EAN
300x300x850 mm	10 kg	3 kg	black grey	1000x200x160 mm	5908252961627 5908252961634



STANDS

**NEW
PRODUCT**



FEATURES

- Full Internal Cable management
- Heavy stable base
- Adjustable tilt angle
- Includes anti-theft system
- Customization options

FEATURES PHOTO

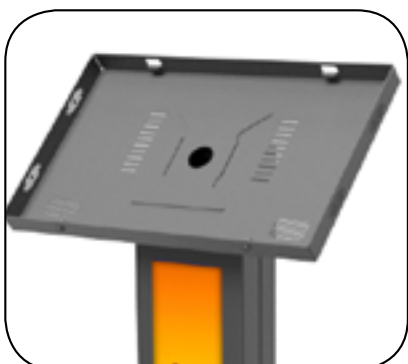

PRODUCT	IMAGE	ADJUSTMENT RANGE	MAX. CAPACITY	VESA	WEIGHT	DIMENSIONS
ITS03		29°/44°	8 kg	min. 75x75 max. 100x100	24 kg	400x525x1140 mm
ITS03L		29°/44°	8 kg	min. 75x75 mm max. 100x100 mm	24 kg	400x525x1140 mm
ITS03P		29°/44°	8 kg	min. 75x75 max. 100x100	24 kg	400x525x1140 mm



Indoor tablet kiosk

TS07

FEATURES

- Modern Design, slim mount casing
- Heavy stable base
- Customization options
- Includes security screw theft-protection

TECHNICAL



10 kg



STANDS

PRODUCT SPECIFICATION

Dimensions	Weight	Max capacity	Colour	Packaging dimensions
250x300x1220 mm	14 kg	10 kg	black grey	350x400x1320 mm



Indoor tablet kiosk

ITS08



STANDS

FEATURES

- Low profile design
- Heavy stable base
- Customization options
- Includes security screw theft-protection

TECHNICAL



10 kg

PRODUCT SPECIFICATION

Dimensions	Weight	Max capacity	Colour	Packaging dimensions
350x350x1050 mm	12 kg	10 kg	white black	450x450x1150 mm



MOUNT



FEATURES

- 360° rotation for portrait or horizontal screen option
- Complete vertical and horizontal adjustability
- Allows dual mounting options: through desk or edge of desk
- Easy and simple installation in just 2 steps

TECHNICAL



min.
75x75 mm
max.
100x100 mm



30°



360°



3 kg

PRODUCT SPECIFICATION

Dimensions	Weight	Max capacity	Colour	Packaging dimensions
115x115x170 mm	3 kg	3 kg	black	215x215x270 mm



FEATURES

- Flexible mounting options
- Includes anti-theft system
- Customization options
- Low profile design
- Easy and simple installation in just 3 steps

TECHNICAL



min.
75x75 mm
max.
100x100 mm



30°



360°



3 kg

**NEW
PRODUCT**



MOUNTS

PRODUCT SPECIFICATION

Dimensions	Weight	Max capacity	Colour	Packaging dimensions
115x115x170 mm	4 kg	3 kg	black	215x215x270 mm



INFOKIOSKS AND ENCLOSURES

FEATURES

Security - including security screws and door locks for theft protection

Easy Maintenance - full screen installation and electrical wiring access included

Universal - complete range of indoor and outdoor options including up to IP65

Customization - full service options including designs, RAL colour, Laser cutting and Vinyl Wrap



19"-27" Indoor Kiosk

IDS01 SERIES

FEATURES

- for 19"-27" LCD screen
- Metal IP65 keyboard with trackball
- Solid steel design
- Tamper-proof glass
- Easy and simple maintenance
- Speakers
- Customization possibilities

TECHNICAL



19"-27"



INDOOR SYSTEMS

PRODUCT SPECIFICATION

Dimensions	Weight	Colour	Packaging dimensions
1500x500x380 mm	50	silver	1600x600x600 mm



19"-27" Indoor Touch Kiosk

IDS02 SERIES

INDOOR SYSTEMS



FEATURES

- for 19"-27" LCD screen
- Solid steel design
- Thermal receipt printer
- Easy and simple maintenance
- Speakers
- Full cable management

TECHNICAL



19"-27"

PRODUCT SPECIFICATION

Dimensions	Weight	Colour	Packaging dimensions	EAN
1340x500x380 mm	50	silver	1400x600x420 mm	5908252965076



INDOOR SYSTEMS



FEATURES

- for 32"-42" LCD touch screen
- Solid steel design
- Easy and simple maintenance
- Customization possibilities

TECHNICAL



32"-42"

PRODUCT SPECIFICATION

Dimensions	Weight	Colour	Packaging dimensions
1315x1000x600 mm	55	silver	1350x1100x1050 mm



FEATURES

- for 32"-65" LCD touch screen
- Modern design
- Glass front
- Easy maintenance
- Solid steel design
- Customization possibilities

TECHNICAL



32"-65"



INDOOR SYSTEMS

PRODUCT SPECIFICATION

Dimensions	Weight	Colour	Packaging dimensions
1992x780 400	130	black	2150x800x500 mm



32"-65" Public Display Stand

IDS05 SERIES

FEATURES

- Solid steel design
- Tamper-proof glass
- Easy and simple maintenance
- Customization possibilities

TECHNICAL



32"-65"



INDOOR SYSTEMS

PRODUCT SPECIFICATION

Dimensions	Weight	Colour	Packaging dimensions
2011,5x950x218 mm	70 kg	black	2100x1100x600 mm



32"-65" Public Display Kiosk

IDS06 SERIES

INDOOR SYSTEMS



FEATURES

- for 32"-65"" LCD screen
- Solid steel design
- Tamper-proof glass
- Easy maintenance
- Customization possibilities

TECHNICAL



32"-65"

PRODUCT SPECIFICATION

Dimensions	Weight	Colour	Packaging dimensions
1980x950x388,5	75 kg	white	2100x970x415 mm



INDOOR SYSTEMS



FEATURES

- Solid steel design
- Tamper-proof glass
- Internal ventilation system
- Easy and simple maintenance
- Customization possibilities

TECHNICAL



42"-46"

PRODUCT SPECIFICATION

Dimensions	Weight	Colour	Packaging dimensions
2210x1235x295 mm	100 kg	black silver	2250x1250x310 mm



FEATURES

- Modern design
- Glass front
- Easy and simple maintenance
- Customization possibilities

TECHNICAL



60"-70"

INDOOR SYSTEMS



PRODUCT SPECIFICATION

Dimensions	Weight	Colour	Packaging dimensions
2200x1120x535 mm	250 kg	silver	2300x1250x60 mm



19"-26" LCD Outdoor Display Stand

ODS01 SERIES

FEATURES

- for 19"-26" LCD screen
- Metal IP65 Keyboard with trackball
- Solid steel design
- Tamper-proof glass
- Easy and simple maintenance
- Customization possibilities

TECHNICAL



19"-26"



OUTDOOR SYSTEMS

PRODUCT SPECIFICATION

Dimensions	Weight	Colour	Packaging dimensions
1996x680x398 mm	95 kg	silver	2100x700x450 mm



40"-55" LCD Public Display Stand

ODS02 SERIES

OUTDOOR SYSTEMS



FEATURES

- Solid steel design
- Anti-glare tamper-proof glass
- Internal ventilation system
- Easy and simple maintenance
- Customization possibilities

TECHNICAL



46"-55"

PRODUCT SPECIFICATION

Dimensions	Weight	Colour	Packaging dimensions
2210x1235x295 mm	70 kg	silver	2250x1250x635 mm



SCREEN ENCLOSURES



FEATURES

- Modern design
- Easy and Simple maintenance
- Glass front
- Customization possibilities

TECHNICAL



PRODUCT SPECIFICATION

Dimensions	Weight	Colour	Packaging dimensions
1200x840x183 mm	60 kg	RAL palette	2250x1250x310 mm



FEATURES

- Solid steel construction
- Modern design
- Tamper-proof glass
- Internal ventilation system
- Easy and simple maintenance
- Front serviceable
- Customization possibilities

TECHNICAL



SCREEN ENCLOSURES

PRODUCT SPECIFICATION

Dimensions	Weight	Max. capacity	Colour	Packaging dimensions
1110x720x180 mm	55 kg	40 kg	silver	1250x850x250 mm



Outdoor LCD Enclosure

OEN02 SERIES

FEATURES

- Solid steel design
- Anti-glare tamper-proof glass
- Internal ventilation system
- Easy and simple maintenance
- Customization possibilities

TECHNICAL



46"



SCREEN ENCLOSURES

PRODUCT SPECIFICATION

Dimensions	Weight	Colour	Packaging dimensions
1777x1680x260 mm	185 kg	silver	2000x1750x350 mm



40"-65" Public Display Stand

VX100

OUTDOOR SYSTEMS



FEATURES

- Modern Design
- Solid steel design
- Tamper-proof glass
- Internal ventilation system
- Easy and simple maintenance
- Customization possibilities

TECHNICAL



40"-65"

PRODUCT SPECIFICATION

Dimensions	Weight	Colour	Packaging dimensions
500x1100x2300 mm	110 kg	white	600x1200x2400 mm



SCREEN ENCLOSURES



FEATURES

- Modern Design
- Solid steel design
- Tamper-proof glass
- Internal ventilation system
- Easy and simple maintenance
- Customization possibilities

TECHNICAL



40"-65"

PRODUCT SPECIFICATION

Dimensions	Weight	Colour	Packaging dimensions
500x930x2300 mm	110 kg	white	600x1030x2400 mm



FEATURES

- Modern Design
- Solid steel design
- Tamper-proof glass
- Internal ventilation system
- Easy and simple maintenance
- Customization possibilities

TECHNICAL



40"-65"

NEW PRODUCT



SCREEN ENCLOSURES

PRODUCT SPECIFICATION

Dimensions	Weight	Colour	Packaging dimensions
600x1020x2325 mm	120 kg	white	700x1120x2425 mm



FEATURES

- Modern Design
- Solid steel design
- Easy and simple maintenance
- Customization possibilities

TECHNICAL



40"-47"



SCREEN ENCLOSURES

PRODUCT SPECIFICATION

Dimensions	Weight	Colour	Packaging dimensions
600x1150x1400 mm	100 kg	white	700x1250x1500 mm

QUICK REFERENCE INDEX

PROJECTOR MOUNTS

PM1 - Universal Projector Ceiling Mount (3 fixing points)	20
PM2 - Universal Projector Ceiling Mount (4 fixing points)	20
PM3 - Universal Projector Ceiling Mount (3 fixing points)	21
PM7 - Universal Projector Wall Mount (3 fixing points)	21
PM8 - Universal Projector Ceiling Mount	22
PSC21 - Indoor Projector Theft Delay Housing - small	23
PT01 - Projector Trolley	23
WPM1 - Universal Projector Ceiling Mount (3 fixing points)	24

ACCESSORIES

PMA1 - I- beam mount for projectors	25
PMALK100 - Safety padlock	25
PMARM100 - Decorative finishing ring for projectors	25
PMAFP100 - 1 metre fixed length pole	25

TROLLEYS AND STANDS

STD02 - 32"-47" Screen Stand	28
STD03 - 19"-32" LCD Stand	28
STD01 - 32"-55" Screen Stand	29
STD04 - 19"-32" LCD Stand	30
SV52 - 19"-27" LCD Stand	31
TR1 - 42"-70" Flat Screen AV Trolley	31
STD15 - 32"-47" Screen Stand	32
STD16 - 32"-47" Screen Stand	32
TR5 - 37"-60 Flat Screen AV Trolley	33
TR2 - 42"-70" Flat Screen AV Trolley	34
TR4 - 37"-60" Flat Screen AV Trolley	34
TR51 - 37"-60" Flat Screen AV Trolley	35
TR7 - 37"-60" Flat Screen AV Trolley	35
TR8 - 37"-60" Low Level Flat Screen Trolley	36
TR9 - 37"-60" Flat Screen AV Trolley	36
TR10 - 37"-60" Flat Screen AV Trolley	37
TR17 - 32"-55" Flat Screen AV Trolley	37
TR18 - 60"-95" Flat Screen AV Trolley	38
TR12 - 37"-60" Dual Flat Screen AV Trolley	38
TR3 - 37"-60" Dual Flat Screen AV Trolley	39
TR14 - 40"-47" Dual Flat Screen AV Trolley	39
TR20 - 50"-60" Dual Flat Screen AV Trolley	40
TR21 - 32"-37" Dual Flat Screen AV Trolley	40
TR6.12 - 37"-55" Dual Flat Screen AV Trolley	41
TR6.22 - 37"-55" Quad Flat Screen AV Trolley	41
SV55 - 19"-27" Flat Screen AV Trolley	42
SV53 - 19"-27" Universal Adjustable Trolley with PC Mount	42
ETR1 - ETR1 Trolley for screen 40-55" with electric height adjustment, (black colour)	43
ETR2 - ETR1 Trolley for screen 40-55" with electric height adjustment, (black colour)	43
ETR Series - ETR Series Electric height adjustment trolley	44
ETRE Series - ETRE Series Electric height adjustment trolley	44
EVCT Series - Video Conferencing Trolley for Dual Screens with motorised height adjustment	45
VCTR195 - 65-95" Video Conferencing Trolley incl. CH5, incl TRSM3 and TRAC400	45

EVCT Series - Video Conferencing Trolleys with motorised height adjustment	46
VCTR237 - 27-37" Video Conferencing Trolley for Dual Screens incl. Camera shelf and glass shelf	47
EVCTR247 - 40"-47" Video Conferencing Trolley with motorised height adjustment	47
MTR100 - 65"-70" Mega Trolley	48
MTR101 - 80"-85" Mega Trolley	48
VCTX Series - Video Conferencing Trolley for Dual Screens with height adjustment	48
VCTX Series - Video Conferencing Trolleys height adjustment	49

ACCESSORIES

CH1 - Video Conferencing Camera Shelf for TR1/TR2/TR3 Trolley	50
CH3 - Video Conferencing Camera Holder for LWB, PWB, TWB	50
CH4 - Video Conferencing Camera Holder	50
CH5 - Video Conferencing Camera Holder	50
RH1 - R1/2/3/6 rotating head	50
GD23 - VESA Adapter for TR1/TR2/TR3 trolley	50
TRS1 - Glass shelf for TR1/TR2/TR3 trolley	50
TRS2 - Glass shelf with handle TR1/TR2/TR3 trolley	50
TRS4 - Glass shelf with handle TR4/TR5/TR6 trolley	51
TRSM100 - Metal shelf for TR4/TR5/TR6 trolley	51
TRSM200 - Metal shelf for TR1/TR2/TR3 trolley	51
TRSM1 - Metal shelf for TR1/TR2/TR3 trolley	51
TRSM2 - Metal shelf for power strip	51
TRMS3 - Metal shelf for mini PC	51
TRAD100 - Metal shelf for documents	51
RF1 (4 pcs) - Rubber feet (4x)	51
TRAC100/101 - Computer case with lock (small)	52
TRAC200/201 - Computer case with lock (medium)	52
TRAC300/301 - Computer case with lock (large)	52
TRAC600 - Internal storage for rack mountable components	52
SP1 - Splitted poles for trolleys TR1/TR2/TR3	52
SP2 - Splitted pole for trolleys TR4/TR5	52
FC1 - Flightcase	52

VIDEO WALLS

VWPOP L Series - Quick Release Pop-Out Universal Video Wall Mount, Landscape	54
VWFS Series - Full Service Universal Video Wall, Landscape	56
VWFX Series - Fixed Universal Video Wall Mount, Landscape	57
VWPOP P Series - Quick Release Pop-Out Universal Video Wall Mount, Portrait	58
VWFS Series - Full Service Universal Video Wall, Portrait	60
VWFX Series - Fixed Universal Video Wall Mount, Portrait	61
VWW2255POP-L - Video Wall pop-out for 4 screens 50"-55", Landscape	62
VWC Series - Ceiling Video Walls, Landscape	63
VWT Series - Trolley Video Walls, Landscape	64
VWS Series - Video Wall Stands, Landscape	65
VWFC Series - Video Wall Ceiling-Floor Mounted, Landscape VWC Series	66
VWC Series - Ceiling Video Walls, Portrait	67
VWT Series - Trolley Video Walls, Portrait	68
VWS Series - Video Wall Stands, Portrait	69
VWFC Series - Video Wall Ceiling-Floor Mounted, Portrait	70

QUICK REFERENCE INDEX

FLAT PANEL WALL MOUNTS

ECB300 - 37"-46" Superslim Wall Mount	72
EWB100 - 26"-40" Fixed Wall Mount	72
EWB200 - 40"-65" Fixed Wall Mount	73
PSM1 - 337"-65" Fixed Wall Mount	73
XSM1 - 37"-65" Fixed Wall Mount	74
LWB1 - 26"-42" Fixed Wall Mount	74
PWB1 - 42"-60" Fixed Wall Mount	75
TWB1 - 65"-75" Fixed Wall Mount	75
XWB1 - 80"-95" Fixed Wall Mount	76
LWB3 - 26"-40" Portrait Wall Mount	76
PWB3 - 42"-60" Portrait Wall Mount	77
TWB3 - 65"-75" Portrait Wall Mount	77
XWB3 - 80"-95" Portrait Wall Mount	78
LWB2 - 26"-40" Portrait Wall Mount	78
PWB2 - 42"-60" Tilt Wall Mount	79
TWB2 - 60"-65" Tilt Wall Mount	79
EWB250 - 42"-65" Tilt Wall Mount	80
LWR1 - 26"-40" Swing Arm Wall Mount	80
PWS2 - 32"-50" Swing Arm Wall Mount	81
RMSA1 - 42"-90" Heavy Duty Swing Arm Wall Mount	82
LWS1 - 26"-40" Swing Arm Wall Mount	83
PWR1 - 42"-55" Swing Arm Wall Mount	83
PWS1 - 32"-50" Swing Arm Wall Mount	84
RPWS1 - 42"-70" Heavy Duty Swing Arm Wall Mount.....	84
CMLS2 - 32"-47" Adjustable Ceiling Mount	85
PWS3 - 42"-60" Dual Swing Arm Wall Mount	86
PWS4 - 42"-60" Dual Swing Arm Wall Mount	86
CMS21 - 26"-55" Adjustable Ceiling Mount	87
CPWS1 - 42"-65" Corner Rotating Swing Arm Wall Mount	88
CMS1 - 32"-65" LCD Ceiling Mount	88
CMS2 - 32"-65" Adjustable Ceiling Mount	89
CMS3 - 32"-65" Dual Ceiling Mount	89
CMS4 - 37"-45" Large Triple Ceiling Multi Directional Mount	90
MSV1 - 32"-46" MSV1 Screen Desk Mount	90
MSV2 - 32"-46" MSV2 Screen Desk Mount	91

ACCESSORIES

CMA1 - I-Beam Mount	92
CMARM60 - Decorative finishing ring for ceiling mounts	92
CMALK100 - Safety padlock	92

MENU BOARDS

MB1155-L - 40"-55" Ceiling Menu board for x1 screen, Landscape	94
MB2155-L - Ceiling Menu board for x2 screens 40-55", Landscape	94
MB3155-L - Ceiling Menu board for x3 screens 40-55", Landscape	95
MB1155BB-L - Ceiling Menu board for back to back screen 40-55", Landscape	95
MB3155BB-L - Ceiling Menu board for x3 back to back screens 40-55", Landscape	96
MB2155BB-L - Ceiling Menu board for x2 back to back screens 40-55", Landscape	96
MB1155-P - Ceiling Mount for screen 40-55", Portrait	97
MB2155-P - Ceiling Menu board for x2 screens 40-55", Portrait	97
MB1155BB-P - Ceiling Menu board for back to back screens 40-55", Portrait	98

MB2155BB-P - Ceiling Menu board for x2 back to back screens 40-55", Portrait ..	98
MBW155-L - Menu board for multiscreens configuration 40-55", wall mount, Landscape	99
MB355T-L - Ceiling Menu board for x3 screens 40-55", triangle, Landscape	99
MB455Q-L - Ceiling Menu board for x4 screens 40-47", Squared, Landscape	100
MB455BBS-L - Ceiling Menu board for x4 screens 40-55", back-to-back,stacked mounts, Landscape	100

MONITOR MOUNTS

GD22 - 19"-27" LCD Fixed Wall Mount	102
GD01 - 19"-27" LCD Swing Arm Wall Mount	102
GD02 - 19"-27" LCD Swing Arm Wall Mount	103
GD03 - 19"-27" LCD Wall Mount	103
GD04 - 19"-27" LCD Tilting Wall Mount	104
GD20 - 19"-27" LCD Tilting Wall Mount	105
GD24 - 19"-27" LCD Multi Purpose Mount	105
GD25 - 19"-27" LCD Swing Arm Wall Mount	106
GD26 - 19"-27" LCD Swing Arm Wall Mount	106
MWM111 - 19"-27" LCD Wall Mount with gas spring	107
MWM121 - 19"-27" LCD Wall Mount with gas spring	107
MWM131 - 19"-27" LCD Wall Mount with gas spring	108
MWM221 - 19"-27" LCD Wall Mount with gas spring	108
GD12 - 19"-27" LCD Desk Mount	109
SV01 - 19"-27" LCD Desk Mount	109
SV02 - 19"-27" LCD Desk Mount with gas spring	110
SV03 - 19"-27" LCD Desk Mount	110
GD18 - 19"-27" LCD Swing Arm Wall Mount	111
SV29 - 19"-27" LCD Slim Pole Desk Mount	112
SV30 - 19"-27" LCD Slim Pole Desk Mount	112
SV05 - 19"-27" Dual LCD Desk Mount	113
SV07 - 19"-27" Quad-LCD Desk Mount	113
SV08 - 19"-27" Dual LCD Desk Mount	114
SV09 - 19"-27" Triple LCD Desk Mount	114
SV10 - 19"-27" Triple LCD Desk Mount	115
SV11 - 19"-27" Triple LCD Desk Mount	115
SV04 - 19"-27" LCD Desk Mount with gas spring	116
SV20 - LCD Desk Mount for Dual LCD's Back to Back	117
MDM121 - 19"-27" LCD Desk Mount with gas spring	117
SV16 - 19"-27" Hexa-LCD Desk Mount	118
SV17 - 19"-27" Hexa-LCD Desk Mount	118
SV06 - 19"-27" Dual LCD Desk Mount	119
MDM221 - 19"-27" Dual LCD Swing Arm Desk Mount with gas spring	120
MSA02 - 19"-27" Swing Arm Wall Mount	120
USM1 - 19"-27" Under Shelf LCD Arm	121
SV31 - 19"-27" LCD Ceiling Mount	121
SV34 - 19"-27" LCD Adjustable Ceiling Mount	122
SV35 - 19"-27" Dual LCD Ceiling Mount	122
MSA01 - 19"-27" Adjustable LCD Ceiling Mount	123

QUICK REFERENCE INDEX

ACCESSORIES

GDA01 - VESA Adapter Plate 200x100	124
GDA02 - VESA Adapter Plate 200x200	124
SVA01 - Free Standing LCD Base Plate for SV Series	124
SVA02 - Free Standing LCD Base Plate for SV Series.....	124
CSV1 - Split clamp for SV Series	124
GU81 - PC Mount	124

IPAD SOLUTIONS/TABLETS

IPM01 - iPad Mount	126
ITE1001 - Indoor tablet enclosure - 10"	126
ITE02 - Tablet Enclosure	127
ITE03 - Tablet Enclosure	127
ITSV01 - Tablet Stands with VESA Adapter	128
ITSV Series - Tablet Stands with VESA	128
ITSV03 - Tablet Stands with VESA Adapter	128
ITSO2 Series - Tablet Stands with VESA Adapter	129
ITS Series - Tablet Stands with Enclosure	130
ITSO4 - Tablet Stands with Enclosure	130
ITS03 - Tablet Stands with Enclosure	131
TS07 - Indoor tablet kiosk	132
ITS08 - Indoor tablet kiosk	132
TDM01 - Tablet Mount	133
TDM02 - Tablet Mount	133

INFOKIOSKS

IDS01 SERIES - 19"-27" Indoor Kiosk	136
IDS02 SERIES - 19"- 27" Indoor Touch Kiosk	136
IDS03 SERIES - 32"- 42" Public Display Floor Stand	137
IDS04 SERIES - 32"- 65" Public Display Kiosk	137
IDS05 SERIES - 32"- 65" Public Display Stand	138
IDS06 SERIES - 32"- 65" Public Display Kiosk	138
IDS07 SERIES - 42"- 46" Public Display Stand	139
IDS010 SERIES - Public Display Kiosk 60" - 70"	139
ODS01 SERIES - 19"-26" LCD Outdoor Display Stand	140
ODS02 SERIES - 40"-55" LCD Public Display Stand	140
IEN01 SERIES - LCD/LED Indoor Enclosure	141
OEN01 SERIES - LCD Enclosure	141
OEN02 SERIES - Outdoor LCD Enclosure	142
VX100 - 55" Public Display Stand	142
VX200 - 55"Public Display Stand	143
VX300 - 55" Public Display Stand	143
VX400 - 42" Public Display Floor Stand	144

EDBAK Ltd.
Piotrowice 186
23-107 Strzyżewice
Poland
Tel.: +48 81 562 81 19
Fax: +48 81 562 82 90
www.edbak.com
info@edbak.com

