

GEFEN

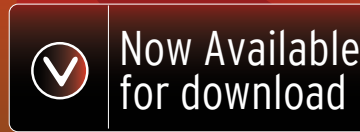



www.gefen.com/download/software

Seamless Performance Through Software

Gefen Syner-G™ Software introduces powerful new management features, enabling a level of performance and control not typically found on standard video distribution systems.

What's new in Gefen Syner-G™ 2.0?

- New and Improved user interface for quick access to Discover and Configure IP, Manage a Product, and EDID Editor
- Added 4K60 4:2:0 Support
- New Firmware Update Detection for supported products
- And more....see Release Notes for details

Discover

- Automatically discover all supported Gefen products on your IP network no matter how it's configured.
- Remotely manage the network settings of your Gefen device.
- The Show Me feature makes finding any Gefen product in your rack a snap.

Update

- Firmware updating has never been easier.
- Checking for the latest firmware update on a Gefen product is a click away.
- Remotely install firmware on any connected Gefen device.

Monitor

- View the status of Gefen connected devices for easy troubleshooting.
- Changes to a device's setting will be updated live in the software interface.
- The Show Me feature makes finding any Gefen product in your rack a snap.

Configure

- Change product settings on-the-fly without the need of an OSD or remote control.
- The layout mirrors the OSD or WEB interface of a Gefen product to make settings discovery quick and easy.
- Advanced configuration options are a click away with built-in shortcuts.

Manage

- Unleash the power of Gefen's EDID tool to control what EDID is passed to a source device.
- The built-in EDID creation tool is a powerful application that will allow the build an EDID from scratch.
- Instantly view and modify any EDID that is stored in a Gefen product, along with any EDID storage banks.

For a list of compatible products, visit gefen.com/synerg

visit gefen.com for product specs and features

Features and specifications are subject to change without notice.

Gefen, LLC is not responsible for typographical errors.

All trademarks and registered trademarks are the property of their respective owners.

Copyright© 2015 Gefen LLC

Version: A2_R1

Experience the Power of 4K ULTRA HD

60Hz, 4:2:0

4K Extenders

- EXT-UHDA-HBT2: HDBaseT™ 2.0 Extender w/ RS-232, Ethernet, 2-way Audio and 2-way IR **NEW**
- GTB-UHD-HBT2: HDBaseT™ 2.0 Extender w/ RS-232 and 2-way IR **NEW**
- EXT-UHD-CAT5-ELRPOL: HDBaseT™ Extender w/ RS-232, Ethernet, and 2-way IR
- GTB-UHD2IRS-ELRPOL-BLK: HDBaseT™ Extender w/ RS-232 and 2-way IR
- GTB-HDBT-POL-BLK: HDBaseT™ Lite Extender w/ 2-way IR
- EXT-HDRS2IR-4K2K-1FO: HDMI Extender over One Fiber w/ RS-232 and 2-way IR

4K Matrixes

- GEF-UHD-89-HBT2: 8x9 Matrix for HDMI with HDCP 2.2 and HDBaseT™ 2.0 **NEW**
- EXT-UHD-88: 8x8 Matrix for HDMI with HDCP 2.2 **NEW**
- GTB-HD4K2K-848-BLK: 8x8 Matrix for HDMI
- GTB-HD4K2K-642-BLK: 6x2 Matrix for HDMI
- GTB-HD4K2K-444-BLK: 4x4 Matrix for HDMI
- GTB-HD4K2K-442-BLK: 4x2 Matrix for HDMI

4K Switcher

- GTB-HD4K2K-441-BLK: 4x1 Switcher for HDMI

4K Splitters

- GTB-HD4K2K-148C-BLK: 1:8 Splitter for HDMI **NEW**
- GTB-HD4K2K-144C-BLK: 1:4 Splitter for HDMI **NEW**
- GTB-HD4K2K-142C-BLK: 1:2 Splitter for HDMI **NEW**

GEF-UHD-89-HBT2

4K Ultra HD 8x9 Matrix for HDMI w/ HDCP 2.2, HDBaseT™ 2.0 & POH
Supports 4K Ultra HD at 60 Hz 4:2:0 and 4K Cinema (DCI - 4096 x 2160) at 30 Hz HDCP 2.2 and 1.4 compliant

- 8x HDMI Inputs
- 8x HDBaseT 2.0 Outputs w/ POH
- 1x Local HDMI Output
- 8x 2-way IR Matrix
- 8x RS-232 Matrix
- Ethernet extension over HDBaseT™ to 8 remote locations
- Integrated web interface
- In-field firmware updates
- Advanced EDID Management
- Complete control from IR to Telnet/UDP
- Gefen Syner-G™ compatible
- Rack-mountable



EXT-UHDA-HBT2



GEF-UHD-89-HBT2



GTB-HD4K2K-144C
1:4 Splitter Shown

GTB-HD4K2K-142C/144C/148C-BLK

4K Ultra HD Splitters for HDMI

Deep Layer Cascading

Supports 4K Ultra HD at 60 Hz 4:2:0 and 4K Cinema (DCI - 4096 x 2160) at 30 Hz
Ten units can be cascaded to create large display arrays

- Perfect for retail showrooms and signage applications
- Advanced EDID Management
- In-Field firmware updates
- Surface-mountable



GTB-HD4K2K-142C-BLK

GTB-HD4K2K-144C-BLK

GTB-HD4K2K-148C-BLK



visit gefen.com for product specs and features

Features and specifications are subject to change without notice.

Gefen, LLC is not responsible for typographical errors.

All trademarks and registered trademarks are the property of their respective owners.

Copyright © 2015 Gefen LLC

Version: A2



Video over IP Solutions

Available for HDMI, DVI and VGA

EXT-HD2IRS-LAN: HDMI over IP w/ RS-232 and 2 Way IR

EXT-HDKVM-LAN: HDMI KVM over IP

EXT-DVIKVM-LAN: DVI KVM over IP

EXT-DVIKVM-LAN-L: DVI KVM over IP w/ Local DVI Out

EXT-VGAKVM-LAN: VGA KVM over IP

Create a Scalable Virtual Matrix of Any Size - up to 65,000 units

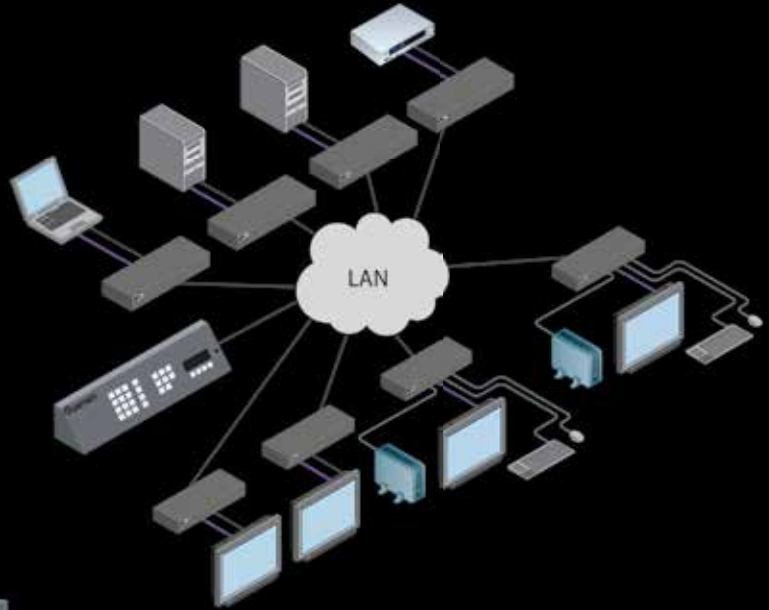

Designed for use with



EXT-CU-LAN: Matrix Controller **NEW**

Features:

Hardware Controller for Video over IP Products

- Unique and versatile solution that sits in your equipment rack or on your meeting table

Comprehensive User Access Control

- Designed to monitor and control source access
- Group and user level access management
- Isolated control and video networks

How Easy Is It Really?

- One button auto IP assignment
- Automatic device detection using Gefen Syner-G™ Discovery service
- Flexible control options including front panel, IR remote, third-party automation control devices using Telnet/UDP, and a powerful and intuitive web server interface



Web Server Interface

visit gefen.com for product specs and features

Features and specifications are subject to change without notice.
 Gefen, LLC is not responsible for typographical errors.
 All trademarks and registered trademarks are the property of their respective owners.
 Copyright© 2015 Gefen LLC
 Version: A2



Wireless Extenders for HDMI 1080p Full HD



EXT-WHD-1080P-LR



NEW!

Wireless Extender for HDMI 5 GHz w/ Dual Inputs and Local Output - Long Range

Sends high definition audio and video to any HDTV display up to 100ft/30m

- Uncompressed A/V from source to display with less than 2 frames latency
- Transmits through walls and obstacles – does not require line-of-sight
- Long Range performance makes it ideal for multi-room use
- Supports 7.1-channels of LPCM digital audio & 5.1 channels of Dolby® or DTS®
- 2 HDMI Inputs and a local HDMI output
- IR back channel for source control
- CEC pass-through
- Ideal for connection and control of 2 sources in a home theater installation
- Up to eight Senders can be accessed by one Receiver
- Compact Receiver unit with IR Extender module can be hidden away
- Flexible mounting options for Sender and Receiver
- Field updatable via USB port, using Gefen Syner-G™ software
- No set up required



EXT-WHD-1080P-SR



NEW!

Wireless Extender for HDMI 5 GHz w/ Compact Sender - Short Range

Sends high definition audio and video to any HDTV display up to 30ft/10m

- Uncompressed A/V from source to display with less than 2 frames latency
- Transmits through obstacles, does not require line-of-sight
- Supports 7.1-channels of LPCM digital audio & 5.1 channels of Dolby® or DTS®
- Small form factor Sender connects directly to the HDMI port
- Sender can be powered from any USB port or the included power supply
- Ideal for temporary connection of mobile devices, laptops, cameras, etc.
- Up to eight Senders can be accessed by one Receiver
- Compact Receiver with IR Extender can be hidden away
- Flexible mounting options for Receiver unit
- Field updatable via USB port, using Gefen Syner-G™ software
- No set up required

Wireless Extender for HDMI 60 GHz High Resolution - In-Room solution

Sends high definition audio and video to any HDTV display up to 30ft/10m

- Uncompressed A/V from source to display with less than 1 frame latency
- Supports HBR (High Bit Rate) Dolby® TrueHD, DTS-HD Master Audio™, and LPCM digital audio streams up to 7.1 channels
- Specifically designed for in-room operation only and near zero latency - great for high-end home theater, gaming, and secure environments
- Operates in the uncluttered 60 GHz frequency region, minimizing possible interference from WiFi and household appliances such as cordless phones
- CEC pass-through
- Compact Sender and Receiver units for easy installation
- Field updatable via USB port
- No set up required



GTV-WHD-60G

visit gefen.com for product specs and features

Features and specifications are subject to change without notice.

Gefen, LLC is not responsible for typographical errors.

All trademarks and registered trademarks are the property of their respective owners.

Copyright© 2015 Gefen LLC

Version: A2

Contents

Matrix and Switcher Solutions.....

KVM and Video over IP Extension.....

Extenders.....

Wireless Extenders for HDMI.....

Splitters.....

Scalers/Converters.....

Multi-Format Processor.....

Multiview Switcher.....

Full Product Catalog.....

Detailed product information is available at www.gefen.com

HDMI, the HDMI Logo, and High-Definition Multimedia Interface are trademarks or registered trademarks of HDMI Licensing in the United States and other countries. Dolby, Pro Logic and the double-D symbol are registered trademarks of Dolby Laboratories.

Copyright © 2015 Gefen LLC All trademarks are the property of their respective companies.

Gefen assumes no responsibility for any inaccuracies that may be contained in this catalog. In no event will Gefen LLC be liable for direct, indirect, special, incidental, or consequential damages resulting from any defect or omission in this catalog, even if advised of the possibility of such damages.

*Products may vary graphically.

.....1-13

.....14-18

.....19-31

.....32-38

.....39-45

.....46-56

.....57-59

.....60-62

.....C1-C4



Products identified with this logo or with a "CI" in the detailed catalog pages are available to Core Brands CI dealers.



gefen.com

Matrix and Switcher Solutions





4K Ultra HD 8x8 Matrix for HDMI w/ HDCP 2.2

HDMI 2.0

4K ULTRA HD
60Hz, 4:2:0

4K CINEMA
DCI, 4096 x 2160

HDCP 2.2



The Gefen 4K Ultra HD 8x8 Matrix for HDMI routes eight 4K sources to any combination of up to eight 4K displays. Resolutions up to 4K Cinema-DCI (4096 x 2160 at 24 or 30 Hz 4:4:4) and 4K Ultra HD (3860 x 2160 at 60 Hz, 4:2:0 or 30Hz 4:4:4) are supported. This product is compliant with the latest HDCP 2.2 protocol as well as HDCP 1.4. The Gefen 8x8 Matrix also supports 1080p Full HD, 1920 x 1200 (WUXGA), 3DTV, and Deep Color (up to 1080p resolution). Multichannel digital audio including 7.1 channels of LPCM and HBR (High Bit Rate) digital audio formats such as Dolby® TrueHD and DTS-HD Master Audio™ are also passed through. The Gefen Syner-G™ software's Discovery and Show-Me features simplify initial IP configuration. Each source can be routed to any or all displays, using the front-panel push buttons or the included handheld IR Remote Control. The matrix can also be controlled via RS-232, Telnet, UDP, and Gefen's intuitive and easy-to-use web server interface. An easy-to-read, super-bright OLED front panel display indicates routing status and IP settings.

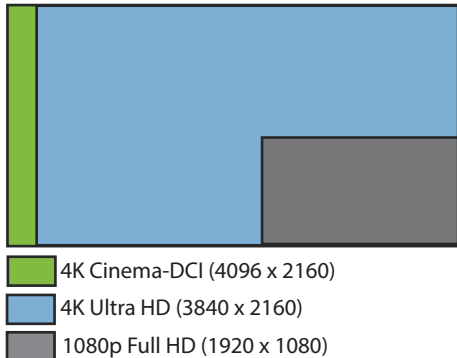

Features*

- Routes eight 4K sources to eight displays
- Supports resolutions up to 4K Cinema-DCI (4096 x 2160 at 24 or 30 Hz), 4K Ultra HD (3860 x 2160 at 60 Hz, 4:2:0 color space), 1080p Full HD, and 1920x1200 WUXGA
- HDCP 2.2 and 1.4 compliant
- Supports 12-bit Deep Color (up to 1080p Full HD)
- 3D pass-through
- Lip Sync pass-through
- Push button controls for Routing and Status
- Advanced EDID Management for rapid integration of sources and displays
- Supports LPCM 7.1, Dolby® TrueHD, Dolby Digital® Plus, and DTS-HD Master Audio™
- Supports the use of DVI sources and DVI displays with HDMI-to-DVI adapters (not included)
- RS-232 Serial interface for use with an automation control system
- IP control via Telnet, UDP, and the built-in web server interface
- IR remote control
- Gefen Syner-G™ software's Discovery and Show-Me features simplify initial IP configuration
- Field-upgradeable firmware via web server interface
- Can be placed on a shelf or mounted in a standard 19-inch wide rack

Specifications*

- Maximum Pixel Clock: 300 MHz
- HDMI Input Connectors: (8) Type A 19-pin female, locking
- HDMI Output Connectors: (8) Type A 19-pin female, locking
- RS-232 serial port: (1) DB-9, female
- Ethernet (IP Control) Port: (1) RJ-45
- Display: OLED, 2 rows, 20 characters per row
- Power Button/Indicator: (1) tact-type, bi-color blue/orange backlight
- Control Buttons/Indicators: (7) tact-type, blue backlight
- IR Sensor: (1), located on front panel
- IR In/Ext Port: (1) 3.5mm mini-stereo jack
- IR Extender type: EXT-RMT-EXTIRN (not included)
- DC Power Connector: (1) 4-pin, locking
- Power Supply: 24V DC
- Power Consumption: 39W maximum
- Operating Temperature: +32 to +122 °F (0 to +50 °C)
- Operating Humidity: 5% to 90% RH, non-condensing
- Storage Temperature: -4 to +140 °F (-20 to +60 °C)
- Storage Humidity: 5% to 95% RH, non-condensing
- MTBF: 50000 hours
- Rack mounting requirements: Standard 19" rack, 2U high
- Dimensions (excluding rack ears and connectors, W x H x D):
17.25" x 3.5" x 15.75" (440mm x 89mm x 400mm)
- Net Unit Weight: 20 lbs. (9.0 kg)
- Shipping Weight: 28 lbs. (12.75 kg)



1080P
PROGRESSIVE

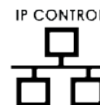

Advanced
EDID
Management

- CAT-5 CABLE**
- HDMI CABLE**
- RS-232 CABLE**
- IR IN**

8x
4K Ultra HD
Source Units

LAN
(for IP Control)

RS-232 Controller

EXT-UHD-88
4K Ultra HD 8x8 Matrix
for HDMI w/ HDCP 2.2

8x
4K Ultra HD
Displays

Automation
Control Device

OR

EXT-RMT-EXTIRN
IR Extender

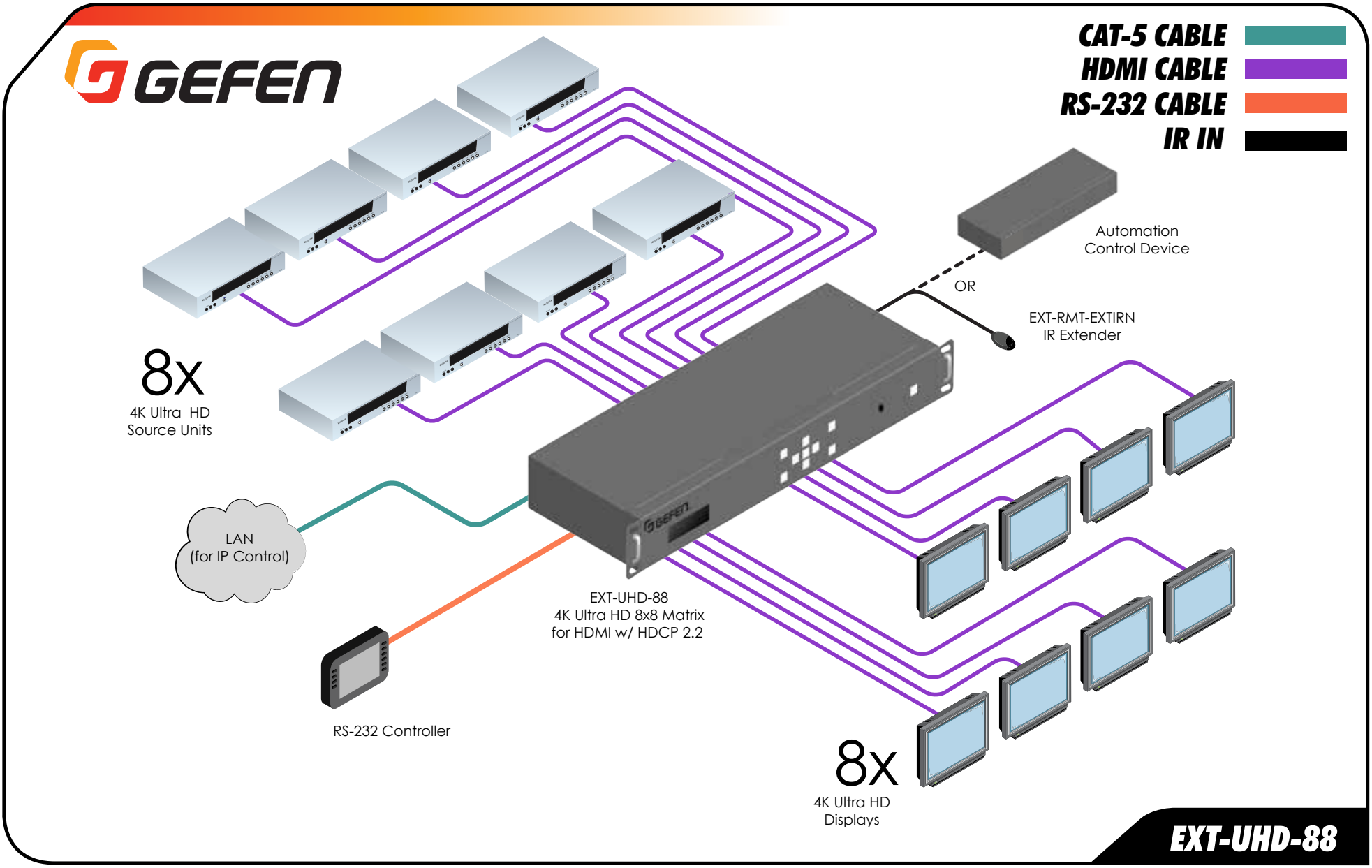

EXT-UHD-88



Ultra HD 4x2 Matrix for HDMI

HDMI[®] 2.0

4K ULTRA HD
60Hz, 4:2:0

4K CINEMA
DCI, 4096 x 2160

HDCP

Route four Hi-Def sources to two Ultra HD displays with FST, 3DTV, and 4K x 2K Ultra High-Definition support

The GefenToolBox 4x2 Matrix for HDMI 4K x 2K is a compact and lightweight alternative to rack-mounted matrixes. It allows up to four Ultra High Definition 4K or 1080p Full HD sources to be routed to up to two Ultra HD displays. This product supports resolutions up to 4K (3840 x 2160 @ 60Hz 4:2:0 or 30Hz 4:4:4) and 4K Cinema (DCI) (4096 x 2160 @ 24 or 30Hz 4:4:4). HDCP, Deep Color, 3DTV pass-through, and lossless audio formats such as LPCM 7.1, Dolby® TrueHD, and DTS-HD Master Audio™ are also supported. Each Hi-Def source can be routed to either of the connected displays using the front panel push-button controls, the included IR remote, RS-232 serial control interface, or through IP, using Telnet, UDP, and the built-in web server interface. LED indicators on the top panel display the current routing status, FST mode, audio configuration, and EDID settings.

FST

Fast Switching Technology (FST) is a Gefen software implementation for HDMI products. FST eliminates the lengthy HDMI authentication process, and allows connecting/disconnecting or turning ON / OFF of HDTV displays without having these activities affect other displays in the same distribution system.

How It Works

Connect up to four Ultra Hi-Def sources to the HDMI inputs on the matrix using HDMI cables. Connect up to two Ultra HD displays to the HDMI outputs. Connect an Ethernet cable from the network to the RJ-45 connector to use the built-in web server or Telnet/UDP capability to control routing, EDID management, and other functions. Connect an RS-232 cable between an automation control device such as Gefen EXT-PACS and GTB-MINI-PACS and the matrix. Connect the included locking power supply to the matrix and to an available electrical outlet. Apply power to the sources and displays. The HD sources can now be routed to the displays using the front panel push-buttons, IR remote control, RS-232, Telnet, UDP, or web server interface.

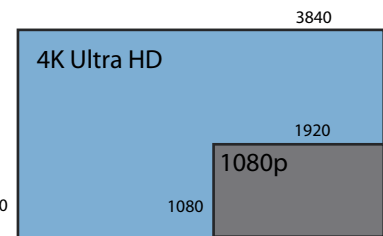

Features*

- Routes four Ultra Hi-Def sources to two Ultra HD displays
- Supports resolutions up to Ultra HD 4K (3840 x 2160 @ 60Hz 4:2:0 or 30Hz 4:4:4), 4K Cinema (DCI) @ 24 or 30Hz 4:4:4, and 1080p Full HD
- HDMI 2.0 compliant
- HDCP 1.4 compliant
- Supports 12-bit Deep Color (up to 1080p Full HD)
- 3DTV pass-through
- Lip Sync pass-through
- Push button controls for Routing, FST Modes, Audio, and EDID management
- FST Technology speeds up HDCP authentication process
- Advanced EDID Management for rapid integration of sources and displays
- Supports LPCM 7.1, Dolby® TrueHD, Dolby® Digital Plus, and DTS-HD Master Audio™
- Supports the use of DVI sources and DVI displays with HDMI-to-DVI adapters (not included)
- RS-232 Serial interface for remote control via a computer or automation control system
- IP control via Telnet, UDP, and the built-in web server interface
- IR remote control
- Field-upgradeable firmware via Mini-USB and IP ports
- Locking Power Supply
- Surface-mountable

Specifications*

- Maximum Pixel Clock: 300 MHz
- HDMI Input Connectors: (4) Type A 19-pin female, locking
- HDMI Output Connectors: (2) Type A 19-pin female, locking
- USB Port: (1) Mini-B
- RS-232 serial port: (1) DB-9, female
- Ethernet (IP Control) Port: (1) RJ-45
- FST Selector: (1) tact-type, recessed push-button
- Audio Selector: (1) tact-type, recessed push-button
- EDID Selector: (1) tact-type, recessed push-button
- Routing Selectors: (2) tact-type push-buttons
- Power Indicator: (1) LED, blue
- FST Indicators: (2) LED, green
- Audio Indicators: (2) LED, green
- EDID Indicators: (3) LED, green
- Routing Indicators: (8) LED, green
- IR Sensor: (1), on front panel
- IR Extender Port: (1) 3.5mm mini-stereo jack
- DC Power Connector: (1) Locking type
- Power Supply: 5V DC
- Power Consumption: 13 Watts (max.)
- Operating Temperature: +32 to 104 °F (0 to +40 °C)
- Dimensions (W x H x D): 6.9" x 5.8" x 1.0" (175mm x 147mm x 26mm)
- Shipping Weight: 5 lbs. (2.3 kg)







1080P
PROGRESSIVE



GTB-HD4K2K-442-BLK

GEFEN
TOOLBOX

- HDMI CABLE** 
- RS-232 CABLE** 
- CAT-5 CABLE** 
- IR EXTENDER** 

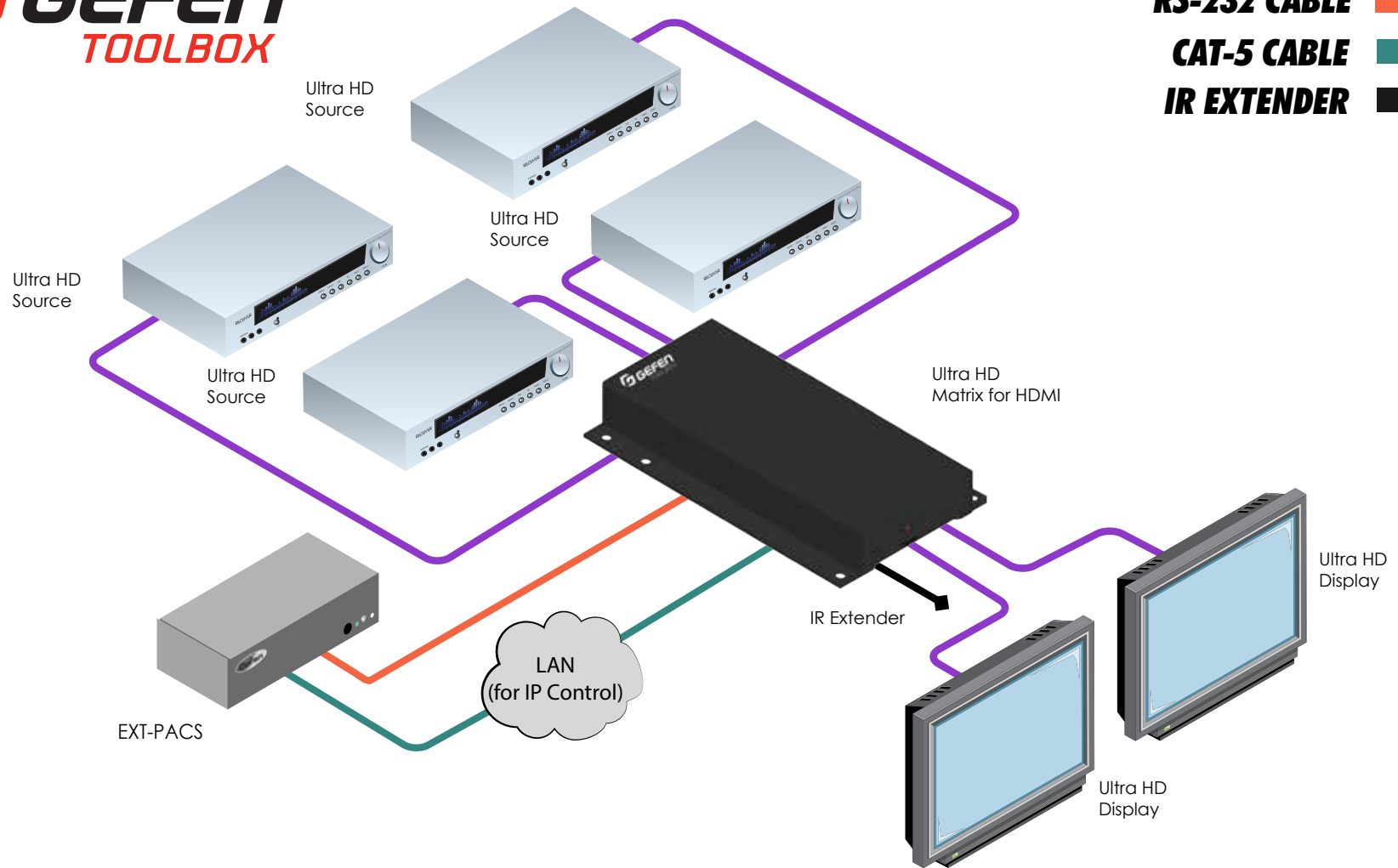

GTB-HD4K2K-442



Ultra HD 4x4 Matrix for HDMI

HDMI® 2.0

4K ULTRA HD
60Hz, 4:2:0

4K CINEMA
DCI, 4096 x 2160

HDCP

Route four Hi-Def sources to four Ultra HD displays with FST, 3DTV, and 4K x 2K Ultra High-Definition support

The GefenToolBox 4x4 Matrix for HDMI 4K x 2K is a compact and lightweight alternative to rack-mounted matrixes. It allows up to four Ultra High Definition 4K or 1080p Full HD sources to be routed to up to four Ultra HD displays. This product supports resolutions up to 4K (3840 x 2160 @ 60Hz 4:2:0 or 30Hz 4:4:4) and 4K Cinema (DCI) (4096 x 2160 @ 24 or 30Hz 4:4:4). Deep Color, 3DTV pass-through, and lossless audio formats such as LPCM 7.1, Dolby® TrueHD, and DTS-HD Master Audio™ are also supported. Each Ultra Hi-Def source can be routed to any of the connected displays using the front panel push-button controls, the included IR remote, RS-232 serial control interface, or through IP, using Telnet, UDP, and the built-in web server interface. LED indicators on the top panel display the current routing status, FST mode, audio configuration, and EDID settings.

FST

Fast Switching Technology (FST) is a Gefen software implementation for HDMI products. FST eliminates the lengthy HDMI authentication process, and allows connecting/disconnecting or turning ON / OFF of HDTV displays without having these activities affect other displays in the same distribution system.

How It Works

Connect up to four Ultra Hi-Def sources to the HDMI inputs on the matrix, using HDMI cables. Connect up to four Ultra HD displays to the HDMI outputs. Connect an Ethernet cable from the network to the RJ-45 connector to use the built-in web server or Telnet/UDP capability to control routing, EDID management, and other functions. Connect an RS-232 cable between an automation control device such as Gefen EXT-PACS or GTB-MINI-PACS and the matrix. Connect the included locking power supply to the matrix and to an available electrical outlet. Apply power to the sources and displays. The HD sources can now be routed to the displays using the front panel push-buttons, IR remote control, RS-232, Telnet, UDP, or web server interface.

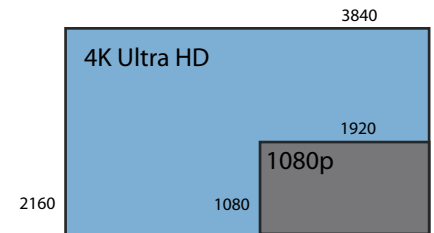

1080P
PROGRESSIVE



Features*

- Routes four Ultra Hi-Def sources to four Ultra HD displays
- Supports resolutions up to Ultra HD 4K (3840 x 2160 @ 60Hz 4:2:0 or 30Hz 4:4:4), 4K Cinema (DCI) @ 24 or 30Hz 4:4:4, and 1080p Full HD
- HDMI 2.0 compliant
- HDCP 1.4 compliant
- Supports 12-bit Deep Color (up to 1080p Full HD)
- 3DTV pass-through
- Lip Sync pass-through
- Push button controls for Routing, FST Modes, Audio, and EDID management
- FST Technology speeds up HDCP authentication process
- Advanced EDID Management for rapid integration of sources and displays
- Supports LPCM 7.1, Dolby® TrueHD, Dolby Digital® Plus, and DTS-HD Master Audio™
- Supports the use of DVI sources and DVI displays with HDMI-to-DVI adapters (not included)
- RS-232 Serial interface for remote control via a computer or automation control system
- IP control via Telnet, UDP, and the built-in web server interface
- IR remote control
- Field-upgradeable firmware via Mini-USB and IP ports
- Locking Power Supply
- Surface-mountable

Specifications*

- Maximum Pixel Clock: 300 MHz
- HDMI Input Connectors: (4) Type A 19-pin female, locking
- HDMI Output Connectors: (4) Type A 19-pin female, locking
- USB Port: (1) Mini-B
- RS-232 serial port: (1) DB-9, female
- Ethernet (IP Control) Port: (1) RJ-45
- Power Indicator: (1) LED, blue
- FST Indicators: (2) LED, green
- Audio Indicators: (2) LED, green
- EDID Indicators: (3) LED, green
- Routing Indicators: (16) LED, green
- FST Selector: (1) tact-type, recessed push-button
- Audio Selector: (1) tact-type, recessed push-button
- EDID Selector: (1) tact-type, recessed push-buttons
- Routing Selectors: (4) tact-type push-buttons
- IR Sensor: (1), on front panel
- IR Extender Port: (1) 3.5mm mini-stereo jack
- DC Power Connector: (1) Locking type
- Power Supply: 5V DC
- Power Consumption: 13 Watts (max.)
- Operating Temperature: +32 to 104 °F (0 to +40 °C)
- Dimensions (W x H x D): 6.9" x 11.9" x 1.0" (175mm x 302mm x 26mm)
- Shipping Weight: 6 lbs. (2.7 kg)



GTB-HD4K2K-444-BLK

GEFEN
TOOLBOX

- HDMI CABLE**
- RS-232 CABLE**
- CAT-5 CABLE**
- IR EXTENDER**

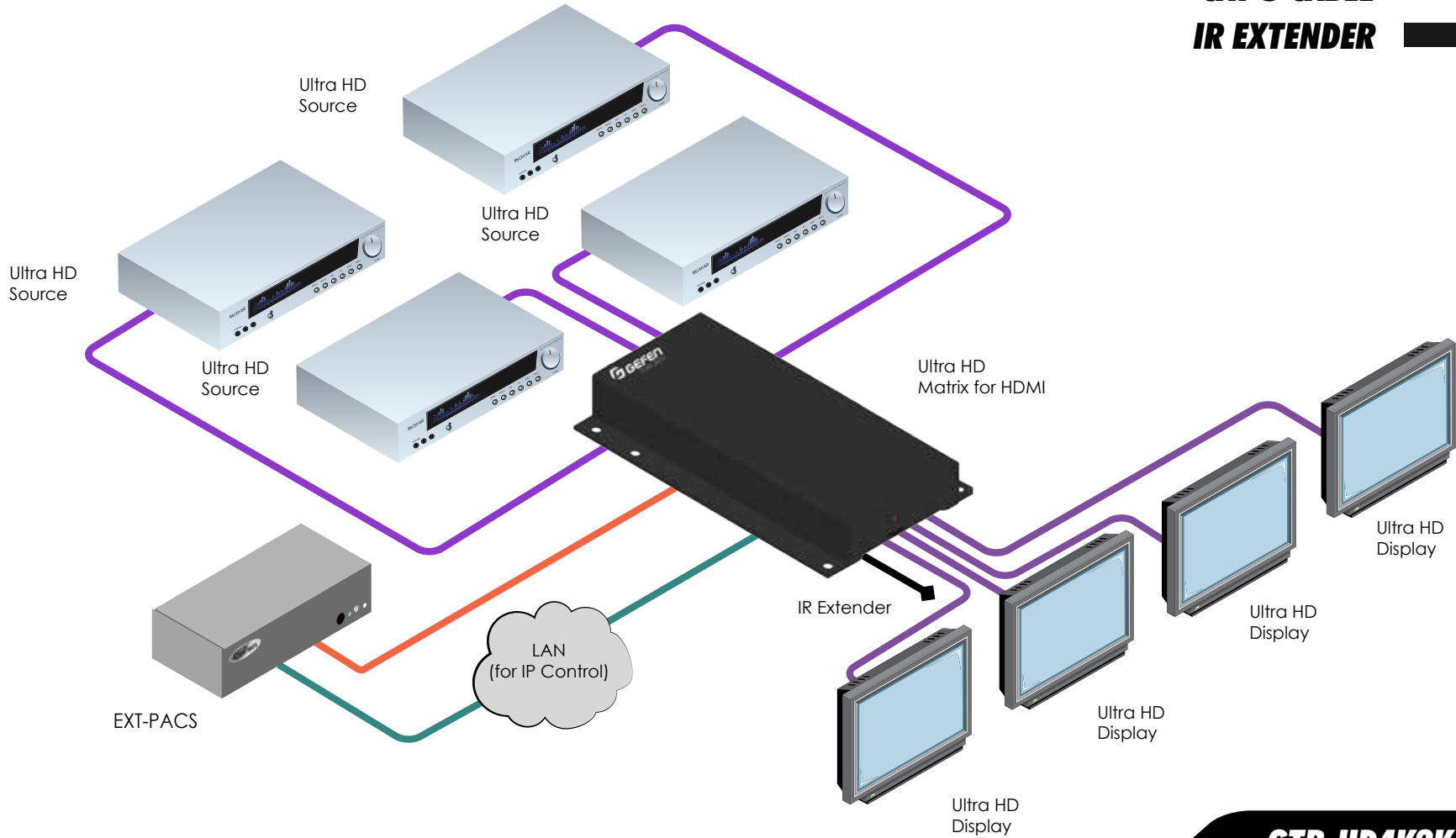

GTB-HD4K2K-444

GEFEN TOOLBOX

Ultra HD 6x2 Matrix for HDMI

HDMI® 2.0

4K ULTRA HD
60Hz, 4:2:0

4K CINEMA
DCI, 4096 x 2160

HDCP

Route six Hi-Def sources to two displays with FST, 3DTV, and Ultra HD 4K x 2K support

The GefenToolBox 6x2 Matrix for HDMI 4K x 2K is a compact and lightweight alternative to rack-mounted matrixes. It allows up to six Ultra High Definition 4K or 1080p Full HD sources to be routed to up to two Ultra HD displays. This product supports resolutions up to 4K (3840 x 2160 @ 60Hz 4:2:0 or 30Hz 4:4:4) and 4K Cinema (DCI) (4096 x 2160 @ 24 or 30Hz 4:4:4). Deep Color, 3DTV pass-through, and lossless audio formats such as LPCM 7.1, Dolby® TrueHD, and DTS-HD Master Audio™ are also supported. In addition to through HDMI, digital audio can also be outputted via the two TOSLINK® optical connectors for use with digital audio processors. Each Ultra Hi-Def source can be routed to either of the connected displays using the front panel push-button controls, the included IR remote, RS-232 serial control interface, or through IP, using Telnet, UDP, and the built-in web server interface. LED indicators on the top panel display the current routing status, FST mode, audio configuration, and EDID settings.

FST

Fast Switching Technology (FST) is a Gefen software implementation for HDMI products. FST eliminates the lengthy HDMI authentication process, and allows connecting/disconnecting or turning ON / OFF of HDTV displays without having these activities affect other displays in the same distribution system.

How It Works

Connect up to six Ultra Hi-Def sources to the HDMI inputs on the matrix using HDMI cables. Connect up to two Ultra HD displays to the HDMI outputs. Using TOSLINK cables, connect up to two A/V Receivers to the Optical outputs. Connect an Ethernet cable from the network to the RJ-45 connector to use the built-in web server or Telnet /UDP capability to control routing, EDID management, and other functions. Connect an RS-232 cable between an automation control device such as Gefen EXT-PACS and GTB-MINI-PACS and the matrix. Connect the included locking power supply to the matrix and to an available electrical outlet. Apply power to the source and displays. The HD sources can now be routed to the displays using the front panel push-buttons, IR remote control, RS-232, Telnet, UDP, or web server interface.

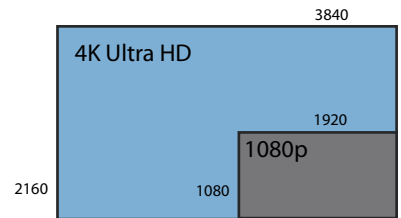

Features*

- Routes six Ultra Hi-Def sources to two Ultra HD displays
- Supports resolutions up to Ultra HD 4K (3840 x 2160 @ 60Hz 4:2:0 or 30Hz 4:4:4), 4K Cinema (DCI) (4096 x 2160 @ 24 or 30Hz 4:4:4), and 1080p Full HD
- HDMI 2.0 compliant
- HDCP 1.4 compliant
- Supports 12-bit Deep Color (up to 1080p Full HD)
- 3DTV pass-through
- Lip Sync pass-through
- Push button controls for Routing, FST Modes, Audio, and EDID management
- FST Technology speeds up HDCP authentication process
- Advanced EDID Management for rapid integration of sources and displays
- Supports LPCM 7.1, Dolby® TrueHD, and DTS-HD Master Audio™
- Supports the use of DVI sources and DVI displays with HDMI-to-DVI adapters (not included)
- RS-232 Serial interface for remote control via a computer or automation control system
- IP control via Telnet, UDP, and the built-in web server interface
- IR remote control
- Field-upgradeable firmware via Mini-USB and IP ports
- Locking Power Supply
- Surface-mountable

Specifications*

- Maximum Pixel Clock: 300 MHz
- HDMI Input Connectors: (6) Type A 19-pin female, locking
- HDMI Output Connectors: (2) Type A 19-pin female, locking
- Digital Audio Outputs: (2) TOSLINK®
- USB Port: (1) Mini-B
- RS-232 serial port: (1) DB-9, female
- Ethernet (IP Control) Port: (1) RJ-45 jack
- FST Selector: (1) tact-type, recessed push-button
- Audio Selector: (1) tact-type, recessed push-button
- EDID Selector: (1) tact-type, recessed push-button
- Routing Selectors: (2) tact-type push-buttons
- Power Indicator: (1) LED, blue
- FST Indicators: (2) LED, green
- Audio Indicators: (2) LED, green
- EDID Indicators: (3) LED, green
- Routing Indicators: (12) LED, green
- IR Sensor: (1), on front panel
- IR Extender Port (Receiver): (1) 3.5mm mini-stereo jack
- DC Power Connector: (1) Locking type
- Power Supply: 5V DC
- Power Consumption: 20 Watts (max.)
- Operating Temperature: +32 to 104 °F (0 to +40 °C)
- Dimensions (W x H x D): 6.9" x 11.9" x 1.0" (175mm x 301mm x 26mm)
- Shipping Weight: 6 lbs. (2.7 kg)



1080P
PROGRESSIVE



GTB-HD4K2K-642-BLK

GEFEN
TOOLBOX

- HDMI CABLE** 
- RS-232 CABLE** 
- CAT-5 CABLE** 
- TOSLINK AUDIO CABLE** 
- IR** 

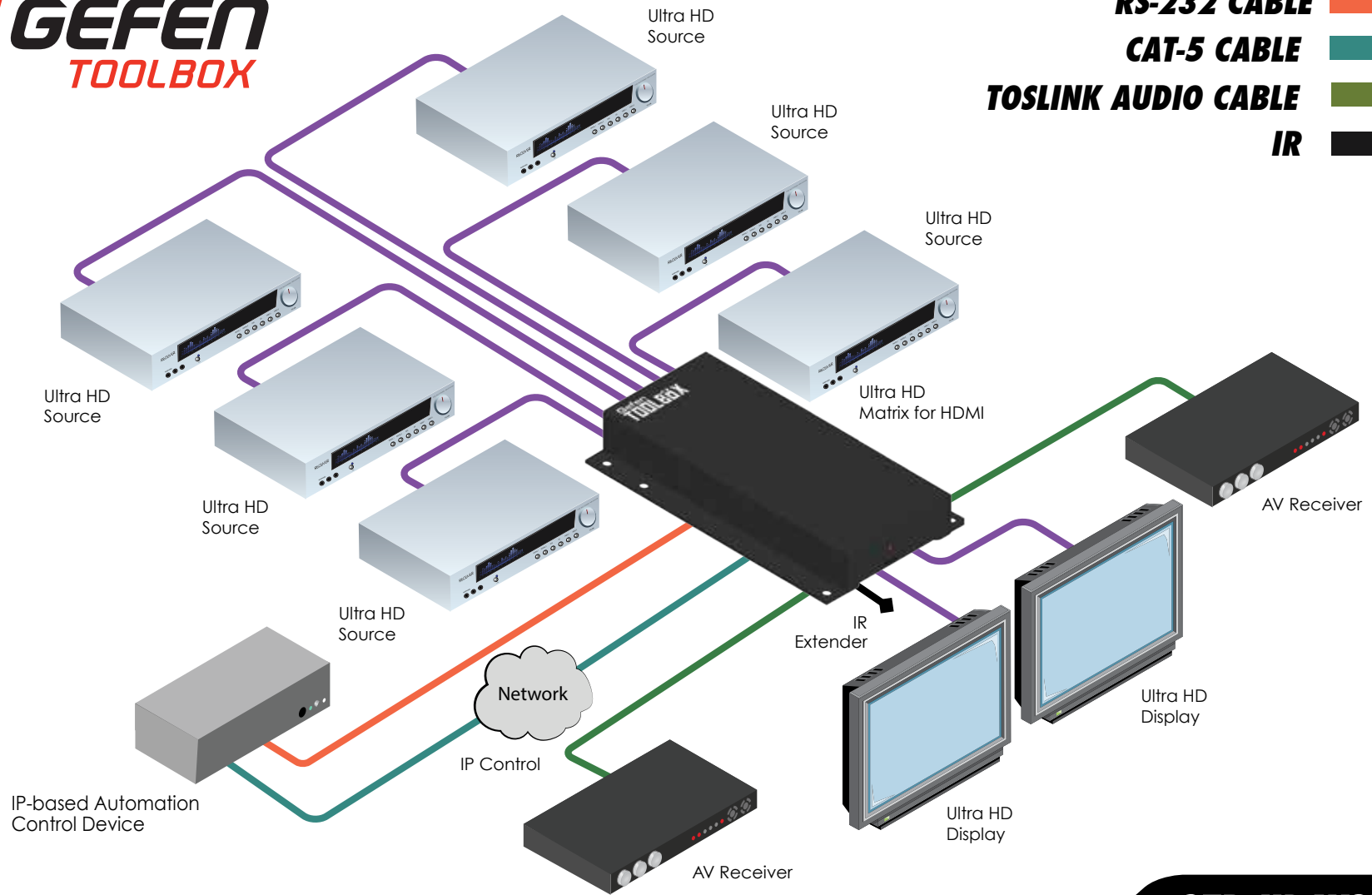

GTB-HD4K2K-642



4K Ultra HD 8x8 Matrix for HDMI



HDCP

Route eight 4K Ultra HD sources to eight displays with HDCP. 3DTV, and 7.1 channel LPCM and HBR Audio support

The Gefen ToolBox 8x8 Matrix is a compact and lightweight alternative to rack-mounted matrices. This HDCP 1.4 compliant matrix routes eight Ultra HD sources to any eight 4K Ultra HD displays with HDMI inputs. Resolutions up to 4K DCI (4096 x 2160 at 24 or 30 Hz 4:4:4), 4K Ultra HD (3860 x 2160 at 60 Hz, 4:2:0 or 30Hz 4:4:4), 1080p Full HD, and 1920x1200 (WUXGA) are supported. 3D, Deep Color, and multichannel digital audio including 7.1 channels of LPCM and HBR (High Bit Rate) formats such as Dolby® TrueHD, and DTS-HD Master Audio™ are also passed through. The Gefen Syner-G™ software's Discovery and Show-Me features simplify initial IP configuration of this matrix. Each source can be routed to any display location, using the front-panel push buttons or the included handheld IR Remote Control. The matrix can also be controlled via RS-232, Telnet, UDP, and Gefen's intuitive and easy-to-use web server interface. An easy-to-read backlit front panel display indicates the current routing status and IP settings.

How It Works

Use HDMI cables to connect up to eight sources with HDMI outputs to the inputs of the matrix. Connect up to eight displays with HDMI inputs to the outputs of the matrix, using HDMI cables. Connect an Ethernet cable from the network to the RJ-45 connector to use the built-in web server or Telnet/UDP capability to control routing, EDID management, and other functions. Connect an RS-232 cable between an automation control device and the matrix. Connect the included power supply to the 24V DC connector on the matrix. Plug the IEC AC power cord to the power supply and to an available AC outlet. To control the matrix via IR, point the included IR remote towards the display of the unit. If matrix is not located in the line of sight of the handheld remote, attach a Gefen EXT-RMT-EXTIRN IR Extender to the IR Ext port of the matrix and install it in a location where it can receive the IR commands. If this matrix is going to be part of an IP-controlled infrastructure, use Gefen Syner-G™ to perform the initial IP configuration and setup.

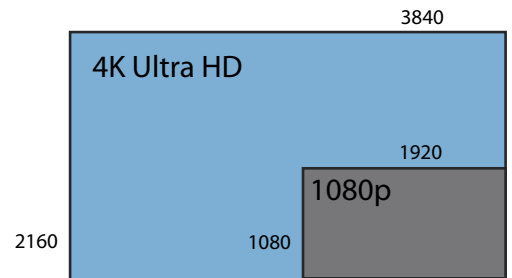

Features*

- Routes eight 4K Ultra HD sources to eight displays
- Supports resolutions up to 4K (DCI) (4096 x 2160 @ 24 or 30Hz 4:4:4), 4K Ultra HD (3860 x 2160 @ 60 Hz 4:2:0 or 30Hz 4:4:4), 1080p Full HD, and 1920x1200 (WUXGA)
- HDCP 1.4 compliant
- Supports 12-bit Deep Color (up to 1080p Full HD)
- 3D pass-through
- Lip Sync pass-through
- Push button controls for Routing and Status
- Advanced EDID Management for rapid integration of sources and displays
- Supports LPCM 7.1, Dolby® TrueHD, Dolby Digital® Plus, and DTS-HD Master Audio™
- Supports the use of DVI sources and DVI displays with HDMI-to-DVI adapters (not included)
- RS-232 Serial interface for remote control via a computer or automation control system
- IP control via Telnet, UDP, and the built-in web server interface
- IR remote control
- Gefen Syner-G™ software's Discovery and Show-Me features simplify initial IP configuration
- Field-upgradeable firmware via web server interface
- Surface-mountable

Specifications*

- Maximum Pixel Clock: 300 MHz
- HDMI Input Connectors: (8) Type A 19-pin female, locking
- HDMI Output Connectors: (8) Type A 19-pin female, locking
- USB Port: (1) Mini-B
- RS-232 serial port: (1) DB-9, female
- Ethernet (IP Control) Port: (1) RJ-45
- Power Indicator: (1) LED, bi-color (red/green)
- Lock Indicator: (1) LED, (orange)
- Display: 2 rows, 16 characters per row
- Control Buttons: (7) tact-type
- IR Sensor: (1), located on front panel
- IR Extender Port: (1) 3.5mm mini-stereo jack
- IR Extender type: EXT-RMT-EXTIRN (not included)
- DC Power Connector: (1) 4-pin
- Power Supply: 24V DC
- Power Consumption: 27W maximum
- Operating Temperature: +32 to +122 °F (0 to +50 °C)
- Operating Humidity: 5% to 90% RH, non-condensing
- Storage Temperature: -4 to +140 °F (-20 to +60 °C)
- Storage Humidity: 5% to 95% RH, non-condensing
- MTBF: 50000 hours
- Dimensions (excluding connectors, W x H x D): 9.3" x 17.9" x 1.75" (236mm x 454mm x 44mm)
- Net Unit Weight: 3.9 lbs. (1.8 kg)



GTB-HD4K2K-848-BLK

GEFEN
TOOLBOX

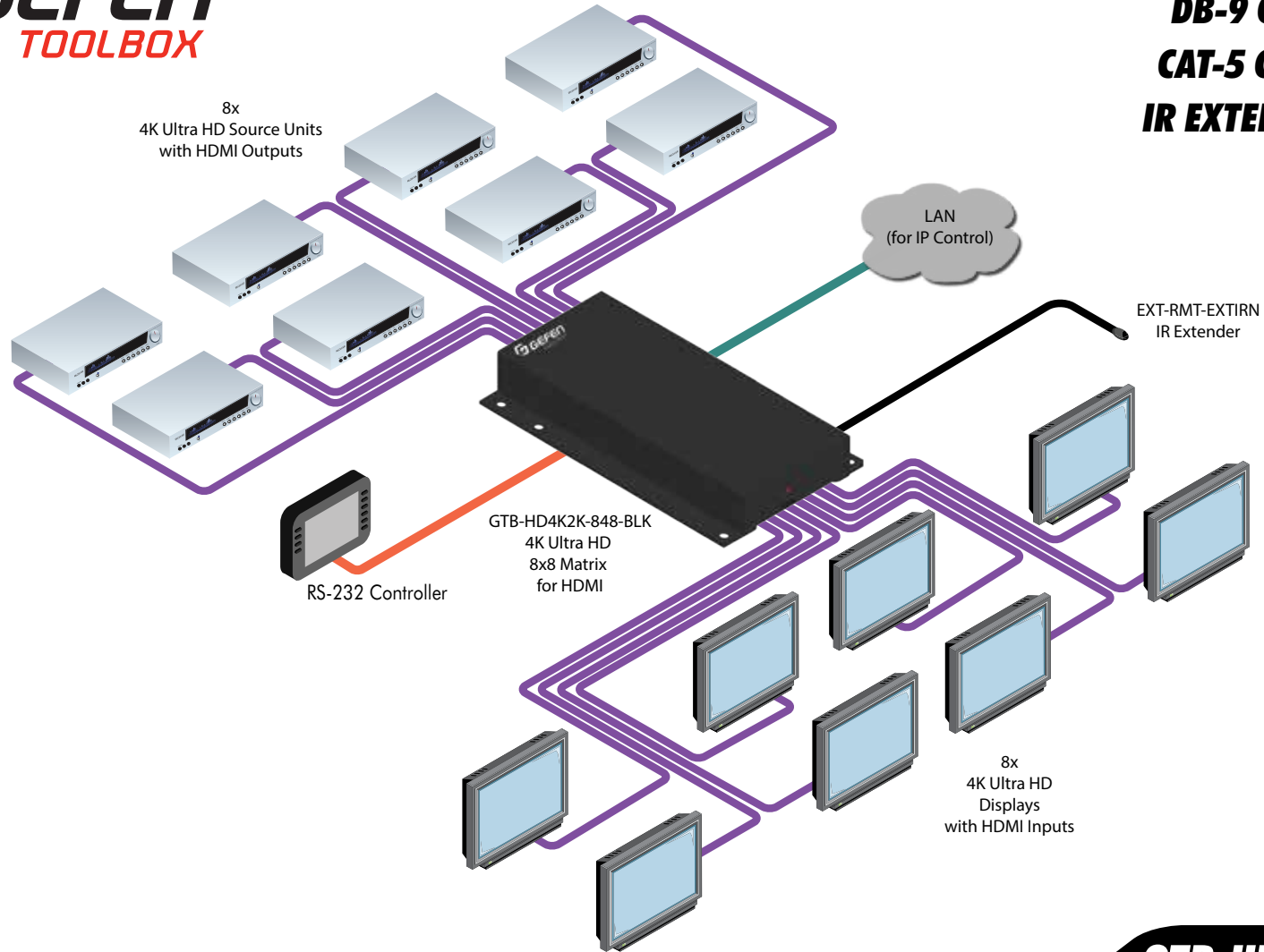

- HDMI CABLE**
- DB-9 CABLE**
- CAT-5 CABLE**
- IR EXTENDER**

GTB-HD4K2K-848-BLK



Ultra HD 4x1 Switcher for HDMI

HDMI[®] 2.0

4K ULTRA HD
60Hz, 4:2:0

4K CINEMA
DCI, 4096 x 2160

HDCP

Switch four Hi-Def sources to one Ultra HD display with 3DTV and 4K x 2K Ultra High-Definition support

The GefenToolBox 4x1 Switcher for HDMI 4K x 2K is a compact and lightweight alternative to rack-mounted matrixes. It allows up to four Ultra High Definition 4K or 1080p Full HD sources to be routed to one Ultra HD display. This product supports resolutions up to 4K (3840 x 2160 @ 60Hz 4:2:0) and 4K Cinema (DCI) (4096 x 2160 @ 24 or 30Hz 4:4:4). HDCP, Deep Color, 3DTV pass-through, and lossless audio formats such as LPCM 7.1, Dolby® TrueHD, and DTS-HD Master Audio™ are also supported. Each Ultra Hi-Def source can be switched to the display using the front panel push-button control, the included IR remote, RS-232 serial control interface, or through IP, using Telnet, UDP, and the built-in web server interface. LED indicators on the top panel display the current switching status.

How It Works

Connect up to four Ultra Hi-Def sources to the HDMI inputs on the switcher using HDMI cables. Connect an Ultra HD display to the HDMI output. Connect an Ethernet cable from the network to the RJ-45 connector to use the built-in web server or Telnet/UDP capability to control switching. Connect an RS-232 cable between an automation control device such as Gefen EXT-PACS or GTB-MINI-PACS and the switcher. Connect the included locking power supply to the switcher and to an available electrical outlet. Apply power to the sources and display. The Ultra HD sources can now be routed to the display using the front panel push-button, IR remote control, RS-232, Telnet, UDP, or web server interface.



1080P
PROGRESSIVE

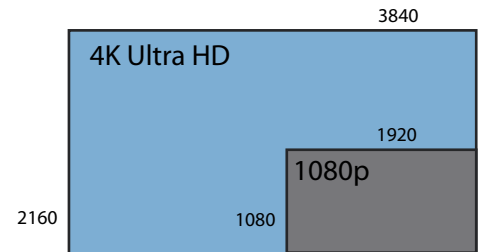

GTB-HD4K2K-441-BLK



Features*

- Switches between four Ultra Hi-Def sources to one Ultra HD display
- Supports resolutions up to Ultra HD 4K (3840 x 2160 @ 60Hz 4:2:0 or 30Hz 4:4:4), 4K Cinema (DCI) @ 24 or 30Hz 4:4:4, and 1080p Full HD
- HDMI 2.0 compliant
- HDCP 1.4 compliant
- Supports 12-bit Deep Color (up to 1080p Full HD)
- 3DTV pass-through
- Lip Sync pass-through
- Push button control for routing sources to display
- Supports LPCM 7.1, Dolby® TrueHD, Dolby Digital® Plus, and DTS-HD Master Audio™
- Supports the use of DVI sources and DVI displays with HDMI-to-DVI adapters (not included)
- RS-232 Serial interface for remote control via a computer or automation control system
- IP control via Telnet, UDP, and the built-in web server interface
- IR remote control
- IR Extender port allows the unit to be mounted in a hidden location
- Field-upgradeable firmware via Mini-USB and IP ports
- Locking Power Supply
- Surface-mountable

Specifications*

- Maximum Pixel Clock: 300 MHz
- HDMI Input Connectors: (4) Type A 19-pin female, locking
- HDMI Output Connector: (1) Type A 19-pin female, locking
- USB Port: (1) Mini-B
- RS-232 serial port: (1) DB-9, female
- Ethernet (IP Control) port: (1) RJ-45
- Switching Selector: (1) tact type push-button
- Switching Indicators: (4) LED, green
- Power Indicator: (1) LED, blue
- IR Sensor: (1), on front panel
- IR Extender Port (Receiver): (1) 3.5mm mini-stereo jack
- DC Power Connector: (1) Locking type
- Power Supply: 5V DC
- Power Consumption: 13 Watts (max.)
- Operating Temperature: +32 to 104 °F (0 to +40 °C)
- Dimensions (W x H x D): 6.9" x 5.8" x 1.0" (175mm x 147mm x 26mm)
- Shipping Weight: 4 lbs. (1.8 kg)

GEFEN
TOOLBOX

HDMI CABLE 
RS-232 CABLE 
CAT-5 CABLE 

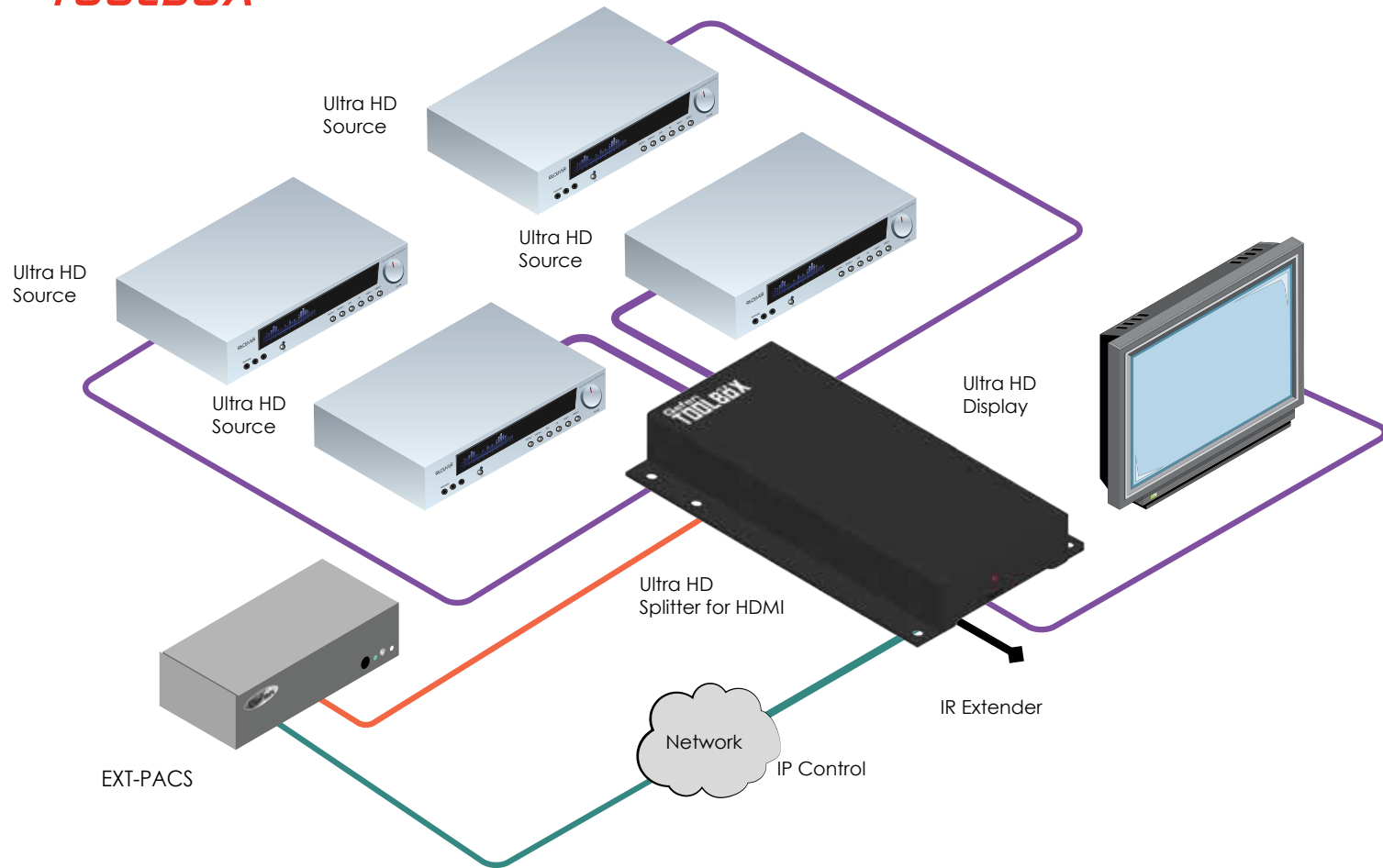

GTB-HD4K2K-441

KVM and Video Over IP Extension





HDMI, RS-232, and Bi-Directional IR Extender over IP

Extend and Distribute HDMI, RS-232, and 2-way IR over a Local Area Network

The HD over IP w/ RS-232 and 2-way IR extends HDMI, RS-232, and bi-directional IR over a Gigabit Local Area Network. Resolutions up to 1080p Full HD and 1920 x 1200 (WUXGA), HDCP, Deep Color, 7.1 channel High Bit Rate digital audio, and Lip-Sync pass-through are supported. The Sender and Receiver units can be automatically or manually configured to unique IP addresses to allow the connection of multiple Senders and Receivers to the same network. Multiple Receiver units can simultaneously connect to any Sender unit within the network including the Gefen KVM over LAN products with HDMI, DVI, or VGA video, to create a virtual crosspoint matrix of just over 65,000 Sender and Receiver units total, depending on the network bandwidth and number of ports on the network switch (see Notes 1 and 2).

IR control can be extended from Sender to Receiver and from Receiver to Sender, allowing the control of source units and displays remotely. The IR input ports on Sender and Receiver units can accommodate both the Gefen powered IR extender EXT-RMT-EXTIRN and electrical IR from automation control devices. RS-232 serial control can also be extended between each Sender and Receiver unit. The built-in web server interface makes control, set-up, and configuration simple and intuitive. When using multiple Senders and Receivers as a "Virtual Matrix", you can connect to any of the Senders within the network by accessing the web interface of each Receiver unit via a web browser on a mobile device or computer, or by using the Gefen KVM/Video over IP Keyboard Switching Controller software (available for download at www.gefen.com). The Gefen HD over IP extender is the perfect solution for large scale remote HD content access and digital signage applications.

How It Works

If you will be connecting multiple Sender units, use the built-in web interface to assign a unique channel ID to each unit. Use the included HDMI cable to connect an HDMI source to the Sender's HDMI input. Using the included mini-phone-plug-to-female-DB-9 adaptor, connect a DB-9 male-to-female RS-232 cable from the Sender unit to an automation control device. If IR extension between the local and remote locations to control the source and the display is needed, connect IR emitters (Gefen part no. EXT-IREMIT) (one included with Sender unit) to the Sender and Receiver units' IR Out ports and attach them to the IR sensor lenses of the source and the display. Connect IR extenders (Gefen part no. EXT-RMT-EXTIRN) (one included with the Receiver unit) or electrical IR outputs from automation control devices to the IR In/Ext ports of the Sender and Receiver units. Using an HDMI cable, connect the HDMI output of the Receiver unit to your display. Using the included mini-phone-plug-to-male-DB-9 adaptor, connect another male-to-female DB-9 cable from the Receiver unit to the display or another RS-232 controlled device. Connect the Sender and Receiver units to each other directly or through a Gigabit Ethernet switch, using CAT-5e or better cables. Each cable run can be up to 330 feet (100 meters) in length. Connect the included 5V power supplies to the Sender and Receiver units and to available electrical outlets. Power-on all associated equipment. Use the Mode selector within the web interface to optimize the picture for sharper still images or smoother video motion.

NOTES:

1. A Gigabit switch is required. The Gigabit switch must support 8k jumbo frame packets in order for multicast mode to operate. If your LAN is not dedicated to Gefen KVM-LAN products exclusively, then a managed switch is highly recommended.
2. When using HDCP-encrypted content, only HDMI Senders and Receiver units can accept and display the content.



EXT-HD2IRS-LAN-TX



EXT-HD2IRS-LAN-RX

Features*

- Extends HDMI, RS-232, and bi-directional IR over IP, using a Gigabit Local Area Network
- Supports resolutions up to 1080p Full HD and 1920 x 1200 (WUXGA)
- Supported HDMI Features:
 - HDCP
 - Deep Color
 - LPCM 7.1 audio, Dolby® TrueHD, and DTS-HD Master Audio™
 - Lip-Sync pass-through
- Built-in web interface facilitates intuitive set up and operation
- Any of the Senders within a network can be accessed by any Receiver unit via a web browser on a mobile device or computer, or by using the Gefen KVM/Video over IP Keyboard Switching Controller software (available for download at www.gefen.com)
- Supports a total of just over 65,000 Sender and Receiver units, depending on the network bandwidth and number of ports on your network switch
- Mode Selector function in web interface for sharpness or motion-optimization of image
- Versatile IR In/Ext ports work with powered Gefen IR extenders and electrical IR from automation control devices
- Field-upgradable firmware via web server interface
- Locking power supply connectors
- RS-232 3.5mm mini-stereo-plug-to-DB-9 adaptors included
- Surface mountable

Specifications*

- Maximum Pixel Clock: 165 MHz
- Maximum TMDS Clock: 225 MHz
- Video Input Connector (Sender): (1) HDMI Type A 19-pin, female, locking
- Video Output Connector (Receiver): (1) HDMI Type A 19-pin, female, locking
- RS-232 ports (Sender/Receiver): (1) 3.5mm mini-stereo jack (DB-9 adaptors included)
- IR Emitter ports (Sender/Receiver): (1) 3.5mm mini-mono jack
- IR In/Extender ports (Sender/Receiver): (1) 3.5mm mini-stereo jack
- IR Extender type: EXT-RMT-EXTIRN
- Ethernet connectors (Sender/Receiver): (1) RJ-45, shielded
- Reset buttons (Sender/Receiver): (1) tact-type, recessed
- Link Indicator (Sender/Receiver): (1) LED, amber
- Power Indicator (Sender/Receiver): (1) LED, green
- Power Supply (Sender/Receiver): 5V DC, locking
- Power Consumption (Sender): 6W maximum
- Power Consumption (Receiver): 4W maximum
- Operating Temperature: 0 to +50 °C
- Operating Humidity: +10 to +90%, Relative Humidity, non-condensing
- Storage Temperature: -20 to +85 °C
- Storage Humidity: 0 to +95%, Relative Humidity, non-condensing
- MTBF: 50000 hours
- Dimensions (Sender/Receiver) (W x H x D): 4.3" x 1" x 3.2" (110mm x 26mm x 80mm)
- Unit Weight: EXT-HD2IRS-LAN-TX: 0.4 lbs. (0.2 kg)
EXT-HD2IRS-LAN-RX: 0.4 lbs. (0.2 kg)
- Shipping Weight: EXT-HD2IRS-LAN-TX: 1.9 lbs. (0.9 kg)
EXT-HD2IRS-LAN-RX: 1.6 lbs. (0.7 kg)





- CAT-5 CABLE** (Up to 330 ft)
- HDMI CABLE**
- RS-232 CABLE**
- IR**

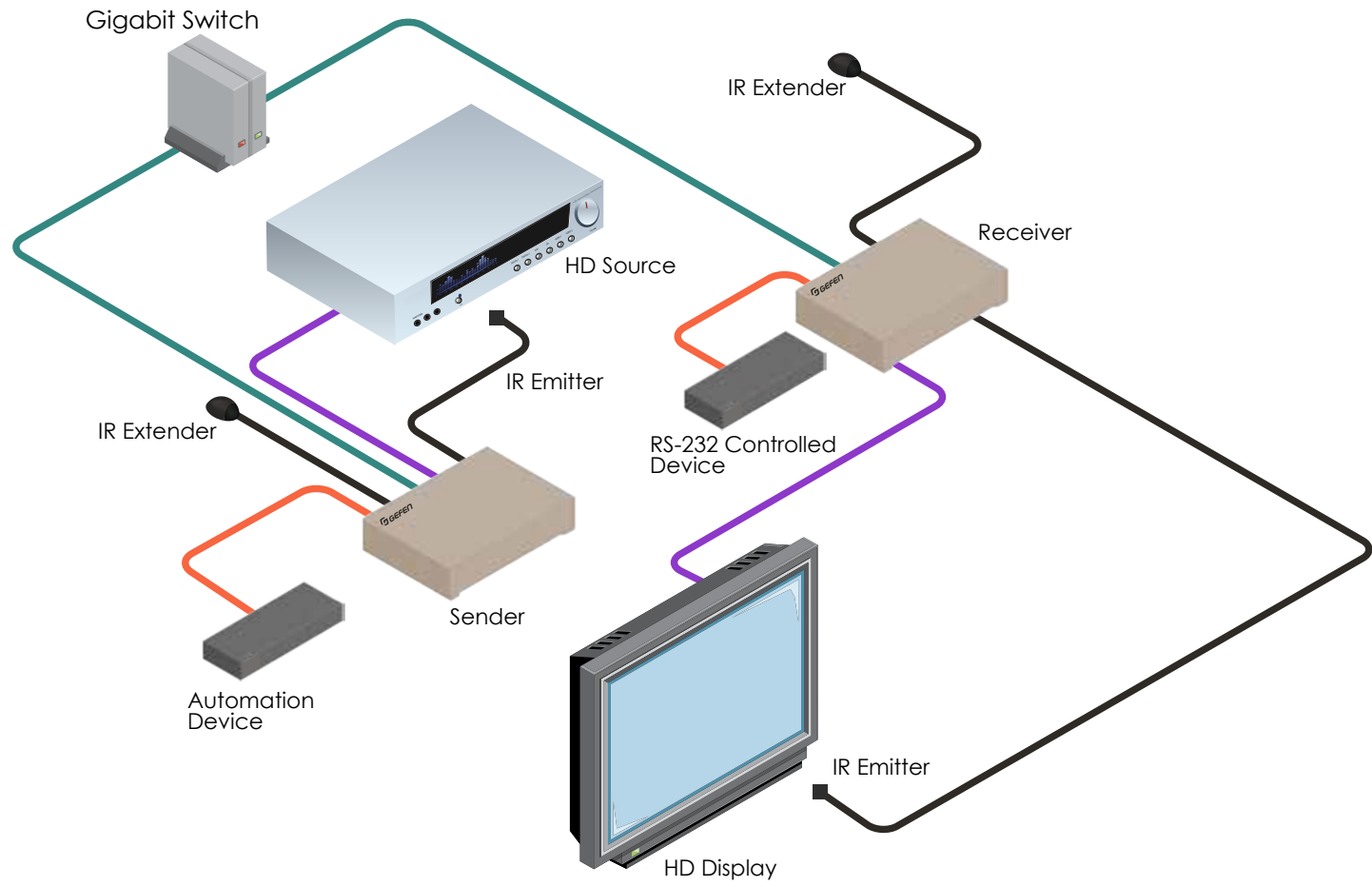

EXT-HD2IRS-LAN

GEFEN Matrix Controller



Intuitive and Powerful
Web Server Interface



EXT-CU-LAN

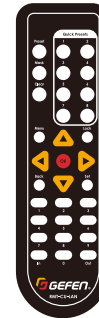

Configure, manage, and control a scalable and expandable virtual matrix using an assortment of Gefen Video and KVM over IP products

The EXT-CU-LAN Matrix Controller is a hardware platform designed to manage and control the Gefen family of Video and KVM over IP products in a virtual matrix environment. Its comprehensive and user-friendly interface can be accessed by any web-enabled device, including phones, tablets, and PCs. End-users can control matrix routing and access presets, no matter the size and complexity of the system. It also manages access to the AV network, providing two independent levels of security for administrators and end-users. Setup of the matrix system is simple and straightforward. All connected Gefen Video or KVM over IP products are automatically detected and configured as necessary. Its conventional front-panel layout includes push-buttons and a 40-character backlit display, dramatically reducing end-user learning curve by emulating a standard AV matrix. The EXT-CU-LAN has been designed to work in conjunction with the Gefen Syner-G™ software, available from the Gefen website. Gefen Syner-G™ simplifies discovery and IP configuration of this product. Once installed on a Local Area Network, the EXT-CU-LAN facilitates quick identification of all Gefen Video and KVM over IP devices that are on the network and assigns IP addresses to them. The Gefen Matrix Controller's unique enclosure shape provides flexible installation options. Its slanted front panel enhances user access to push-buttons and provides for better display readability when placed on a conference table. Its 2U tall enclosure and detachable rack ears facilitate installation in a standard 19-inch-wide equipment rack. In addition to its plethora of user control options via web-enabled handheld devices, front panel, and the included IR remote, this product features Telnet and UDP for integration into an automation control system. With applications ranging from broadcast, rental/staging, control rooms, security, digital signage, campus/education, to multi-room AV, the EXT-CU-LAN provides a complete and cost-effective solution for managing video and audio in classrooms, conference rooms, command centers, and as the backbone of any high performance system that needs to interface with multiple sources and displays, AV formats, and resolutions in a dynamic environment.

How It Works

If this product will be placed on a table or shelf, attach the included rubber feet to the bottom of the unit. If the unit is to be mounted in a standard 19-inch wide equipment rack, attach the two included rack-ears to the front sides of the unit, using the machine screws provided. The EXT-CU-LAN can be set up to manage a single LAN that includes control and AV routing devices, or a system with two independent Local Area Networks; one for system control and another for AV routing. It comes pre-configured to work with a single LAN (its "Network Mode" is set to "Combined"). If your system architecture calls for independent control and AV/KVM routing networks, the matrix controller needs to be set to "Separate" mode. When the EXT-CU-LAN is being used in single network mode, connect the LAN 1 port to the managed switch for this network. The LAN 1 port can also receive Power Over Ethernet (POE), alleviating the need to connect the external 5V DC power supply that ships with the product. If setting up a system with two independent Local Area Networks for system control and AV/KVM routing: Connect the LAN 1 port of the EXT-CU-LAN to the control network. Connect the Ethernet port called LAN 2 to the other Local Area Network that includes the Video/KVM over-IP Senders and Receivers. If POE is not available from the network that is connected to the LAN 1 port, connect the included power supply to the 5V DC power supply jack and to an available electrical outlet. The Power LED will glow in blue and the display will turn on to indicate that the unit is receiving power.

Features*

- Detects, configures, and controls all Gefen Video and KVM over IP products.
- Built-in web server allows access from any web-enabled device, including phones, tablets, and PCs
- Two Ethernet ports with independent IP and MAC Addresses allow segregation of Video/KVM LAN and control LAN, and help provide separate security layers for administrators and end-users.
- Seamless integration with Gefen Syner-G™ software allows for quick installation and configuration on a network
- Automatic assignment of IP addresses for all Gefen Video and KVM over IP devices on a network
- Front panel control push-buttons/display, handheld IR remote, and web server interface allow easy and convenient end-user operation
- Automation control system interface via Telnet and UDP
- POE (Power Over Ethernet) on LAN 1 port eliminates the need for an external power supply
- Password-protected independent user and administrative access
- Easy to read 2 line/20 characters per line Liquid Crystal Display
- System Configuration Upload/Download function
- Plug-and-Play installation with little to no set-up
- Locking power supply connector
- 2U tall rack-mountable enclosure, detachable rack ears included
- Slanted front panel for ergonomic push-button access and display visibility when placed on a table

Specifications*

- Display: 2 lines, 20 characters per line, Liquid Crystal Display, backlit
- Push-buttons: (28) tact-type
- IR Sensor: (1) on front panel
- LAN 1 IP Port: (1) RJ-45 jack, POE-enabled
- LAN 2 IP Port: (1) RJ-45 jack
- Power Indicator: (1) LED, blue
- Power Supply: 5V DC, locking connector
- Power Consumption: 4.3W maximum
- Operating Temperature: +32 to +122 °F (0 to +50 °C)
- Operating Humidity: 5% to 90% RH, non-condensing
- Storage Temperature: -4 to +185 °F (-20 to +85 °C)
- Storage Humidity: 0% to 95% RH, non-condensing
- MTBF: 50000 hours
- Dimensions without rack ears (excluding buttons & connectors, W x H x D):
17" x 3.5" x 2.7" (432mm x 88mm x 68mm)
- Dimensions with rack ears (excluding buttons & connectors, W x H x D):
19" x 3.5" x 2.7" (482mm x 88mm x 68mm)
- Net Unit Weight: 3.7 lbs (1.7 kg)
- Packaged Weight: 5.6 lbs (2.6 kg)



This product has been specifically designed for use with the Gefen Syner-G™ Software Suite, available for download at www.gefen.com

The Gefen Syner-G™ Discovery and Show-Me features simplify initial IP configuration.



CAT-5 CABLE 
VIDEO (HDMI, DVI, VGA) CABLE 
USB CABLE 

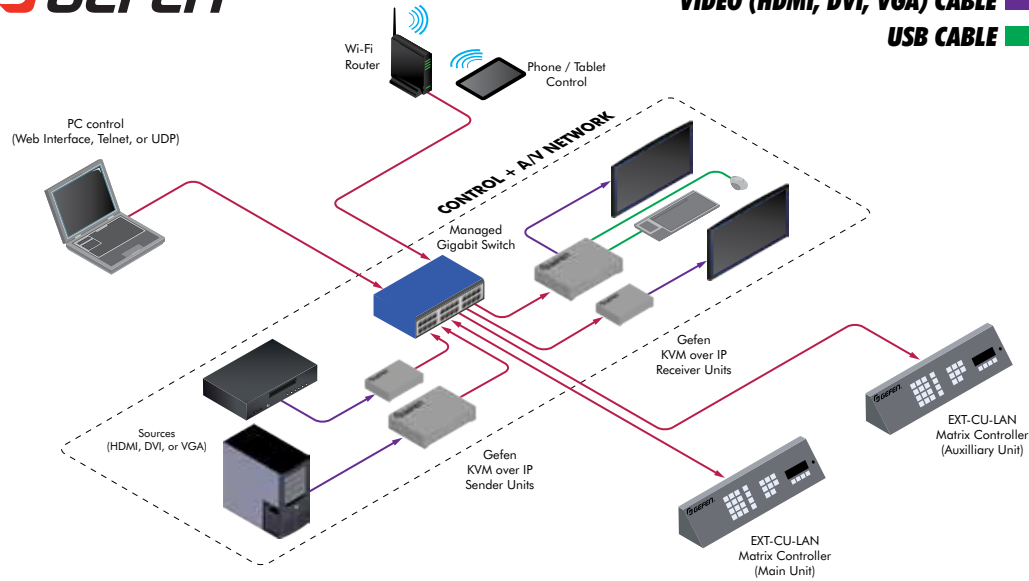

EXT-CU-LAN



CAT-5 CABLE 
VIDEO (HDMI, DVI, VGA) CABLE 
USB CABLE 

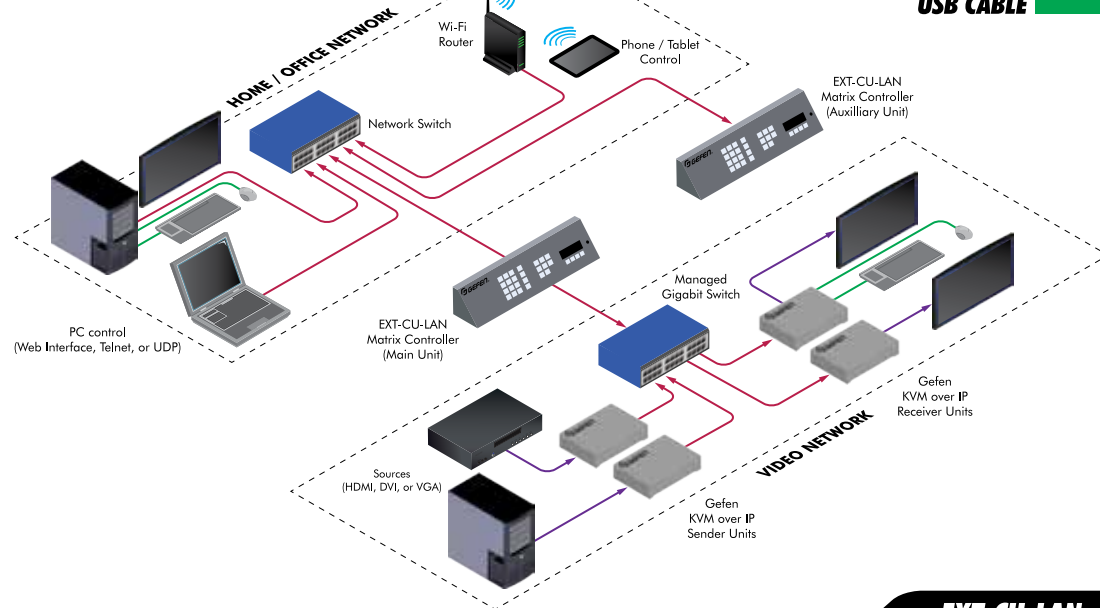

EXT-CU-LAN

Extenders





DVI ELR Extender over one CAT-5 up to 150 meters



EXT-DVI-1CAT5-ELR

Extend DVI up to 495 feet (150 meters) over one CAT-5e cable

The DVI ELR Extender over one CAT5 allows the extension of a DVI source to a display, up to 495 feet (150 meters), using a single CAT-5e cable. This product is capable of HDCP and HPD pass-through. It can also be configured by the installer via DIP switches for maximum range or maximum bandwidth, and for low power consumption (auto sleep mode) or always-on operation. The DVI Extender over one CAT5 uses Gefen's ELR implementation of HDBaseT® technology, allowing the DVI signal to travel along a single CAT-5e or better cable, reducing cable costs and facilitating installation.

How It Works

Use the included DVI cable to connect the computer or other DVI source to the Sender unit. Connect the Receiver unit to a Hi-Def display with a DVI cable. Use up to 495 feet (150m) of CAT-5e cable to connect the Sender to the Receiver unit. Configure DIP switches as necessary. Connect the included locking power supplies to the Sender and the Receiver units and plug the power supplies to available electrical outlets. Power on all connected equipment.

Features*

- Extends DVI up to 495 feet (150 meters) over one CAT-5e cable
- Supports resolutions up to 1080p Full HD and 1920 x 1200 (WUXGA)
- EDID management for rapid integration of source and display
- Enable/Disable switches for HPD pass-through
- Power-Save (Green Mode) selector switch
- 150m/100m range selector switch configures the extender for maximum range (150 meters) or maximum bandwidth
- Locking power supplies
- Surface-mountable

Specifications*

- Maximum Pixel Clock: 165 MHz
- Video Input Connector (Sender): (1) DVI-I, 29-pin, female (digital only)
- Video Output Connector (Receiver): (1) DVI-I, 29-pin, female (digital only)
- Link Connector (Sender/Receiver): (1) RJ-45
- Internal/External EDID Selector (Sender): (1) DIP switch
- HPD Pass-Through Selector (Sender): (1) DIP switch
- Power-Save Selector (Sender/Receiver): (1) DIP switch
- 150m/100m Range Selector (Sender/Receiver): (1) DIP switch
- Power Indicator (Sender/Receiver): (1) LED, blue
- Link Indicator (Sender/Receiver): (1) LED, green
- Power Supply (Sender/Receiver): 5V DC
- Power Consumption (Sender/Receiver): 10 W per unit maximum
- Operating Temperature: 0 to +45°C
- Operating Humidity: 0 to 90% RH, non-condensing
- Dimensions (W x H x D): 4.3" x 1" x 3.4" (110mm x 26mm x 86mm)
- Shipping Weight: 3 lbs (1.4 kg)





CAT5 CABLE 
DVI CABLE 

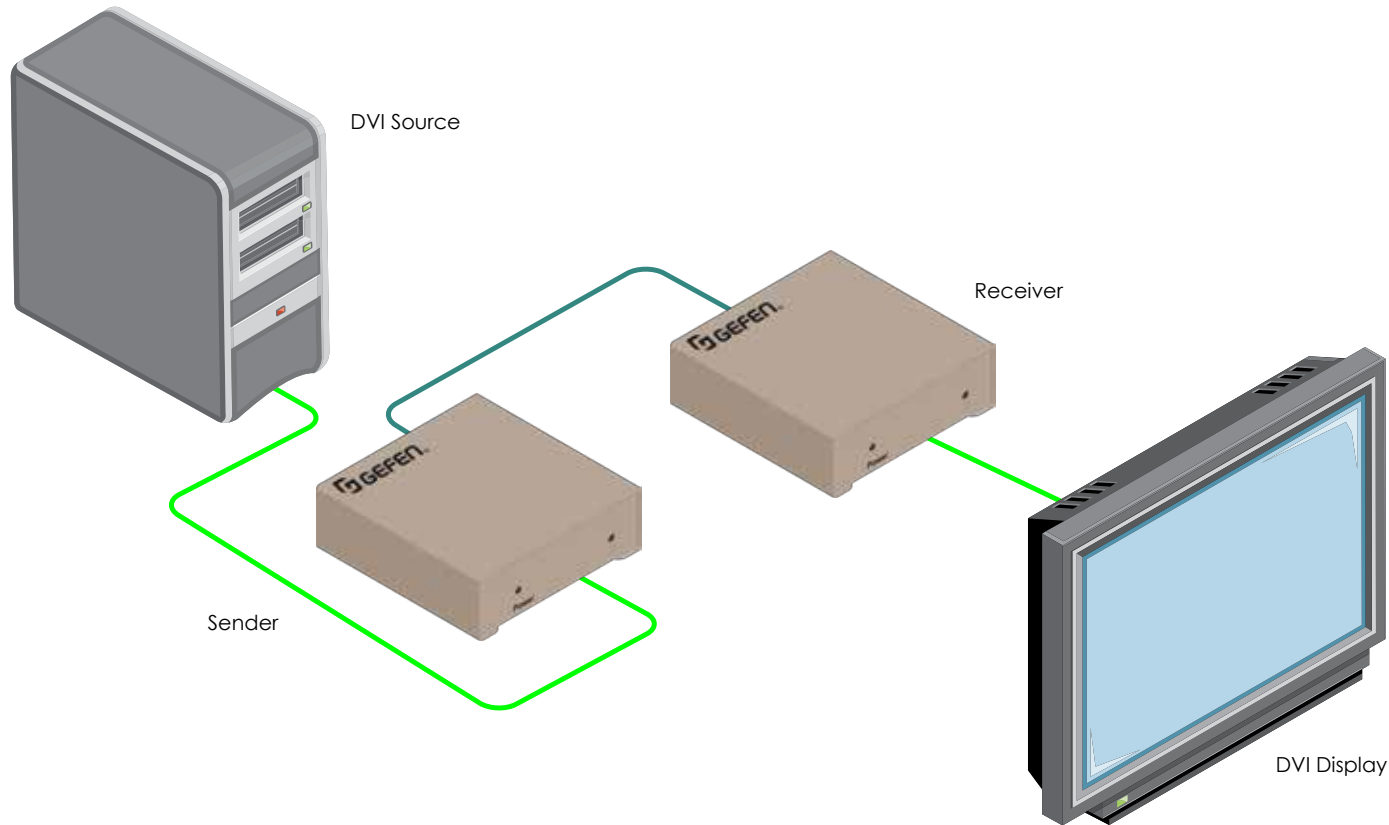

EXT-DVI-1CAT5-ELR



HDMI KVM ELR Extender Over One CAT-5 cable

HDMI[®] 2.0

4K ULTRA HD
60Hz, 4:2:0



HDCP



EXT-HDKVM-ELR

Extra Long Range KVM Extender for HDMI and USB over one CAT-5 cable

The Gefen HDMI KVM ELR extends HDMI and USB up to 330 feet (100 meters) over a single CAT-5 cable. Resolutions up to 4K Ultra HD (3840 x 2160 @ 60Hz 4:2:0 or @ 30Hz 4:4:4), 4K Cinema-DCI (4096 x 2160 @ 24 or 30Hz), 1080p Full HD, and 1920 x 1200 (WUXGA) are supported. HDCP, USB 2.0 up to 30 Mbps, and USB 1.1 are also supported. The Receiver unit accommodates up to three USB devices, providing access to keyboard, mouse, touch-panels, printers, scanners, and external storage media. Typical applications include remote workstations and interactive digital signage with touch-screens. This product uses Gefen's ELR implementation that integrates the proven HDBaseT™ technology with powerful EDID Management capabilities. HDMI and USB are transported over the same CAT-5e cable, reducing cabling costs in addition to providing easier and more reliable installation.

How It Works

Place the HDKVM ELR Sender unit next to the computer source and use the included HDMI cable to connect the computer to the Sender unit. Use the supplied USB cable to connect the USB host (source) device to the USB port on the Sender unit. Connect the Receiver unit to a display with an HDMI cable. Connect the USB devices to the Receiver unit. Use one CAT-5e cable, up to 330 feet (100 meter), to connect the Sender unit to the Receiver unit. Connect the included locking power supplies to the Sender unit and Receiver unit, and then connect both power cords to available electrical outlets.

Features*

- Extends 4K Ultra HD (3840 x 2160 @ 60Hz, 4:2:0 or 30Hz, 4:4:4), and USB over a single CAT-5e cable up to 330 feet/100 meters (8-bit color)
- Extends 4K Cinema (DCI) (4096 x 2160 @ 24 or 30Hz 4:4:4), and USB over a single CAT-5e cable up to 330 feet/100 meters (8-bit color)
- Extends HDMI at 1080p Full HD, and USB over a single CAT-5e cable up to 330 feet/100 meters (up to 12-bit Deep Color)
- HDMI Features Supported:
 - HDMI 2.0
 - HDCP 1.4 compliant
 - 12-bit Deep Color
 - LPCM 7.1 audio, Dolby® TrueHD, Dolby Digital® Plus, and DTS-HD Master Audio™ pass-through
 - 3DTV pass-through
 - CEC pass-through
 - Lip Sync pass-through
- Supports up to 30 Mbps when using USB 2.0
- Backward-compatible with USB 1.1
- EDID management for rapid integration of source and display devices
- ELR and HDBaseT technologies
- Locking power supplies
- 1U tall, half-rack width enclosures are rack-mountable using EXT-RACK-1U

Specifications*

- Maximum Pixel Clock: 300 MHz
- Maximum TMDS Clock: 300MHz
- Video Input Connector (Sender): HDMI Type A, 19-pin, female, locking
- Video Output Connector (Receiver): HDMI Type A, 19-pin, female, locking
- USB Connector (Sender): (1) Type B, female
- USB Connector (Receiver): (3) Type A, female
- Link Connector (Sender / Receiver): RJ-45, shielded
- Service Connector for field upgrades (Sender / Receiver): USB mini-B
- Power Supply (Sender / Receiver): 5V DC, locking
- Power Consumption (Sender / Receiver): 10W (max.)
- Operating Temperature: +32 to +104 °F (0 to +40 °C)
- Dimensions (W x H x D): 8.5" x 1.75" x 4.5" (216mm x 45mm x 114mm)
- Shipping Weight: 6 lbs. (2.7 kg)





CAT-5e (or better) CABLE 

HDMI CABLE 

USB 

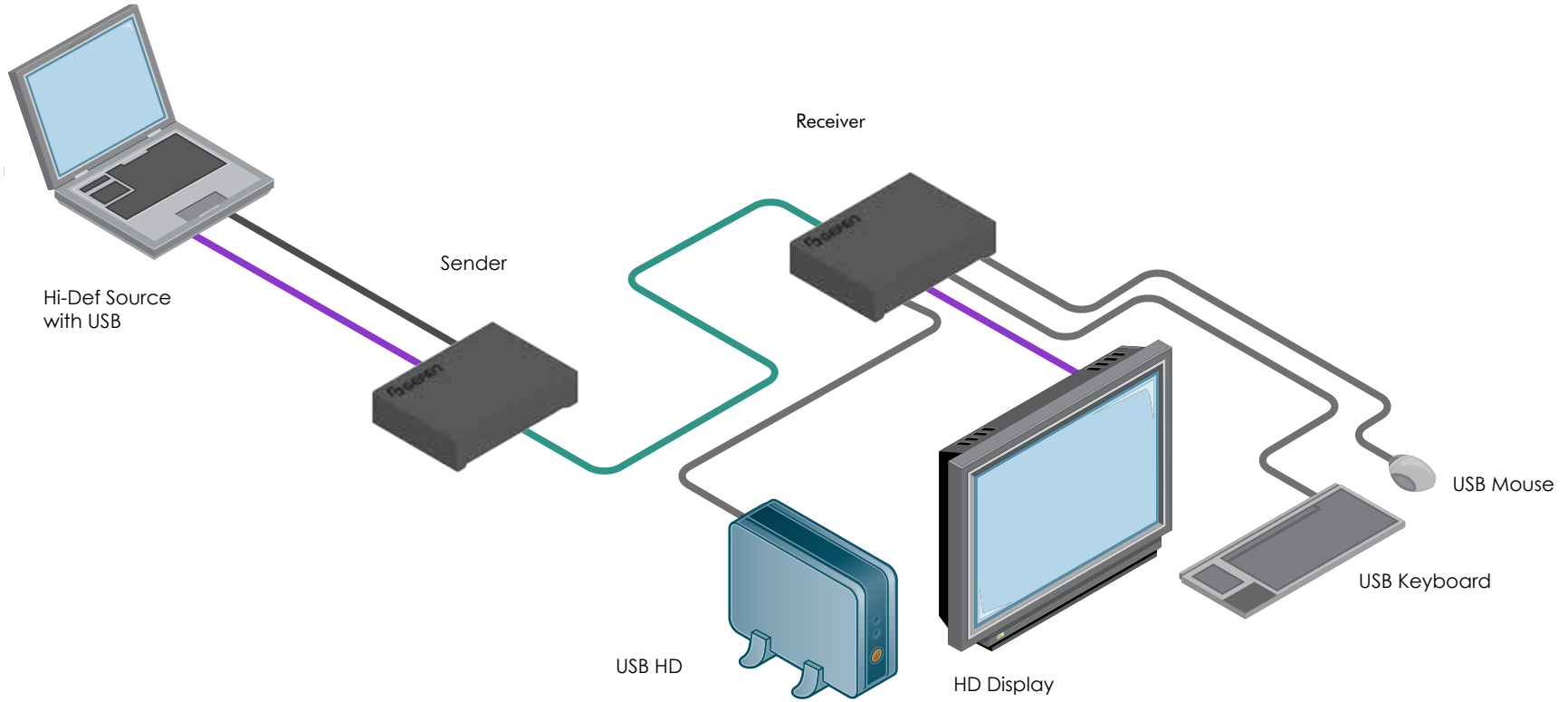

EXT-HDKVM-ELR



4K Ultra HD Extender for HDMI over One Fiber w/ RS-232 and 2-way IR

HDMI[®] 2.0

4K ULTRA HD
60Hz, 4:2:0



HDCP



EXT-HDRS2IR-4K2K-1FO

Extend HDMI with 4K Ultra HD support, RS-232, and Bi-Directional IR over one fiber optic cable up to 3300 feet (1000 meters)

The Gefen 4K Ultra HD Extender for HDMI over One Fiber is a complete solution, allowing HDMI, RS-232 and Bi-Directional IR to be extended up to 3300 feet (1000 meters) at 4K resolution and up to 6600 feet (2000 meters) at 1080p60 Full HD. This product works with any HDMI source and supports resolutions up to 4K Ultra HD (3840 x 2160 @ 60Hz 4:2:0) and 4K Cinema (DCI) (4096 x 2160 @ 24 or 30Hz 4:4:4). This HDCP-compliant extender is the ideal for installations where the HDMI source and display are located apart from each other in an interference-prone operating environment. A single strand of SC-terminated multi-mode fiber optic cable is used for extension, providing excellent protection from electromagnetic interference (EMI), and preserving signal integrity. The Automatic Virtual EDID feature allows automatic copying of the Extended Display Identification Data (EDID) to the sender unit for continuous availability to the source. This allows rapid recovery of picture upon display power up or when used in conjunction with Switchers and Matrixes. Compared to similar copper-based solutions, optical signal transmission provides inherent galvanic isolation and excellent immunity to electromagnetic interference. These Sender and Receiver modules also feature metal enclosures, providing further protection against radiated noise. Locking HDMI and power connectors ensure trouble-free installation and long-lasting, reliable operation.

How It Works

The Sender unit is placed near the source and the Receiver unit near the Display. Connect the supplied locking HDMI cable between the Sender unit and the source. Connect an HDMI cable between the Receiver unit and the display. Connect the included DB-9 cable from an RS-232 automation device to the Sender unit. Connect another male-to-female DB-9 cable between the Receiver unit and an RS-232-controlled device on the Receiver side (such as the display). To send an IR control signal from the viewing location to the source unit, connect the IR output from an automation control device or the included Gefen EXT-RMT-EXTIRN IR Extender to the IR In/Ext port on the Receiver, and connect an IR Emitter to the IR Out on the Sender unit to IR Sensor window of the source. To control devices at the viewing location (such as the display) from the source side, use the IR In/Ext port on the Sender side and the IR Out connection on the Receiver side. Connect one strand of multi-mode fiber optic cable, with SC connectors, between the Sender and the Receiver units. Connect the locking power supplies to the Sender and the Receiver units and plug them into electrical outlets. Power up all associated equipment.

Features*

- Extends HDMI, RS-232, and Bi-Directional IR over a single strand fiber optic cable
- Extends 4K Ultra HD (3840 x 2160 @ 60Hz, 4:2:0, or 30Hz, 4:4:4) up to:
 - 3300 feet (1000 meters) over 50/125µm OM3e/OM4 fiber
 - 500 feet (150 meters) over 50/125µm (OM3) fiber
 - 165 feet (50 meters) over 62.5/125µm (OM1) fiber
- Extends 4K Cinema (DCI) (4096 x 2160 @ 24 or 30Hz, 4:4:4) up to:
 - 3300 feet (1000 meters) over 50/125µm OM3e/OM4 fiber
 - 500 feet (150 meters) over 50/125µm (OM3) fiber
 - 165 feet (50 meters) over 62.5/125µm (OM1) fiber
- Extends 1080p Full HD (1920 x 1080 @ 60Hz) up to:
 - 6600 feet (2000 meters) over 50/125µm OM3e/OM4 fiber
 - 1000 feet (300 meters) over 50/125µm (OM3) fiber
 - 330 feet (100 meters) over 62.5/125µm (OM1) fiber
- HDMI Features Supported:
 - HDMI 2.0
 - HDCP 1.4
 - 12-bit Deep Color
 - LPCM 7.1 audio, Dolby® TrueHD, and DTS-HD Master Audio™
 - 3DTV pass-through
 - Lip Sync pass-through
- RS-232 extension
- 2-way IR extension
- Auto Virtual EDID
- Automatic calibration based on the type and length of fiber optic cable
- Full duplex RS-232 up to 115200 baud
- Firmware upgradable via USB
- Inherently immune to electromagnetic interference (EMI)
- Locking power supplies
- Surface-mountable

Specifications*

- Maximum Pixel Clock: 300 MHz
- HDMI Connectors (Sender/Receiver): (1) HDMI Type A, 19-pin, female , locking
- RS-232 Connector (Sender): (1) DB-9, female
- RS-232 Connector (Receiver): (1) DB-9, male
- USB Connectors (Sender/Receiver): (1) USB Mini-B, female
- IR Out Connector (Sender/Receiver): (1) 3.5mm mini-mono jack, female
- IR In/Ext Connector (Sender/Receiver): (1) 3.5mm mini-stereo jack, female
- IR Extender type: EXT-RMT-EXTIRN
- Link Connectors (Sender/Receiver): (1) SC type
- Link Indicators (Sender/Receiver): (1) LED, green/red
- Power Indicators (Sender/Receiver): (1) LED, blue/red
- Bi-Directional IR Carrier Pass-through Frequency Range: 30 kHz to 60 kHz
- Power Supply (Sender/Receiver): 5V DC
- Power Consumption (Sender/Receiver): 2.5W each maximum
- Operating Temperature: +32 to +113 °F (0 to +45 °C)
- Operating Humidity: 5% to 90% RH, non-condensing
- Storage Temperature: -4 to +185 °F (-20 to +85 °C)
- Storage Humidity: 0% to 95% RH, non-condensing
- MTBF: 50000 hours
- Dimensions (W x H x D, Sender/Receiver): 4.3" x 1" x 3.4" (110mm x 26mm x 86mm)
- Net Weight (Sender/Receiver): 0.4 lbs (0.2 kg) each
- Shipping Weight: 3.0 lbs. (1.4 kg)



FIBER OPTIC (SC-SC) CABLE 

HDMI CABLE 

RS-232 CABLE 

IR IN 

IR OUT 

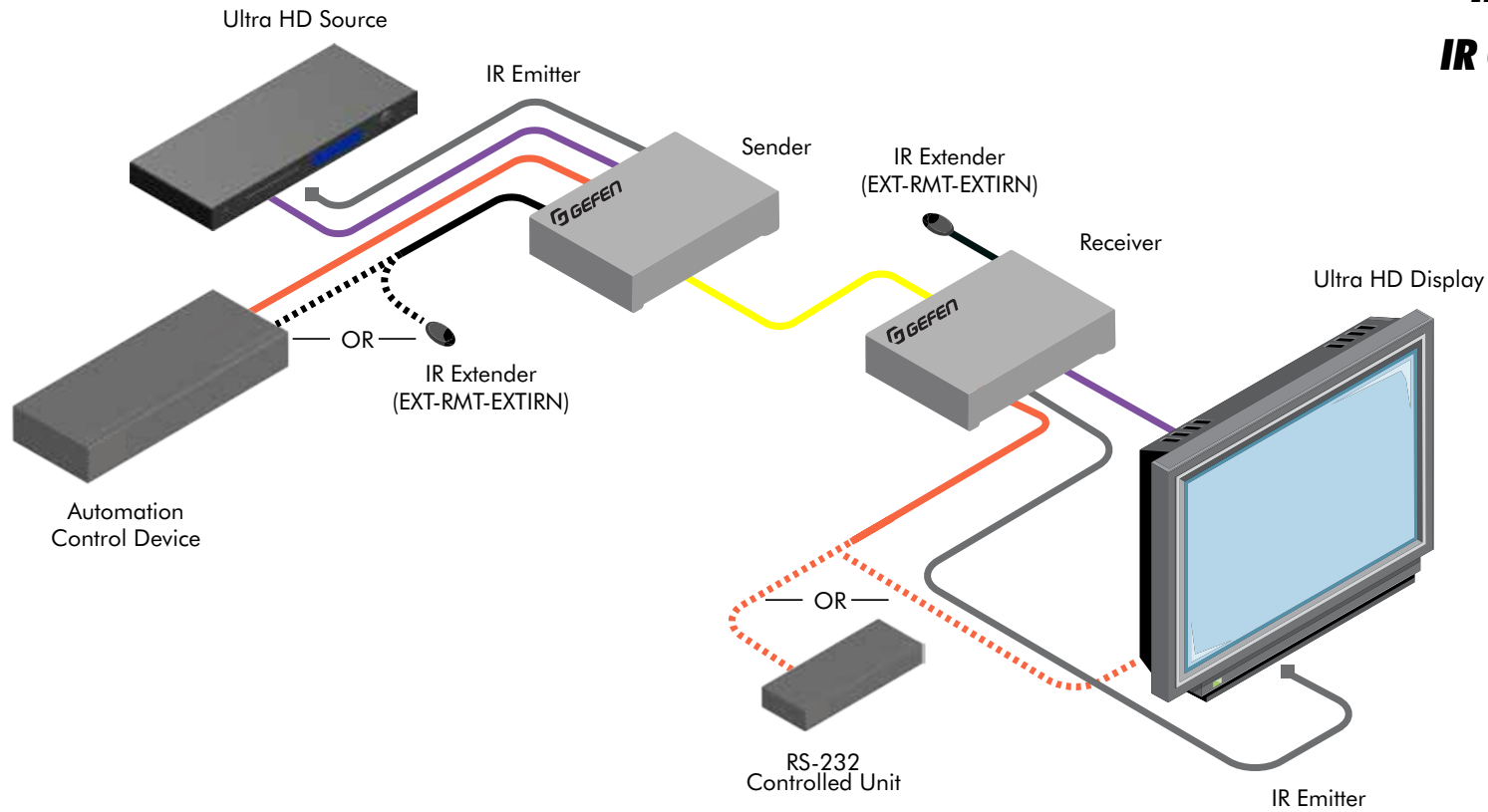

EXT-HDRS2IR-4K2K-1FO



4K Ultra HD Extender for HDMI over One CAT-5 with Ethernet, RS-232, Bi-Directional IR, and POL



EXT-UHD-CAT5-ELRPOL

HDMI[®] 2.0

4K ULTRA HD
60Hz, 4:2:0



HDCP 2.2

Extend HDMI, Ethernet, RS-232, and 2-way IR over one CAT-5e cable, up to 495 feet (150 meters)

The Gefen 4K Ultra HD ELR-POL Extender uses the Gefen implementation of the HDBaseT™ technology to extend HDMI up to 495 feet (150 meters) using one CAT-5e cable. Resolutions up to 4K Ultra HD (3840 x 2160 @ 60 Hz 4:2:0) with 7.1 channels of HBR (High Bit Rate) lossless digital audio are supported.

This product provides Ethernet, RS-232 and 2-way IR extension between the Sender and the Receiver units, making 10/100BaseT wired Ethernet connection available at the remote location without the need to run a separate cable. It also allows the transfer of IR commands and RS-232 communications between two remote locations. RS-232 and Bi-Directional IR can be used to control A/V sources placed near the Sender unit and to send automation commands to the display or another device placed near the Receiver unit. Gefen Bi-Directional POL (Power Over Line) technology powers the Sender or the Receiver unit using the same cable that extends the HDMI signal. Only one of the two units needs a power supply. This feature simplifies installation.

How It Works

The Sender unit is placed near the source and the Receiver unit near the Display. Connect the supplied locking HDMI cable between the Sender unit and the source. Connect an HDMI cable between the Receiver unit and the display. Connect an RS-232 automation device to the Sender unit using the included Phoenix-to-female DB-9 cable. Connect the Receiver unit to an RS-232-controlled device (such as the display) using the included Phoenix-to-male DB-9 cable. To send an IR control signal from the viewing location to the source unit, connect the IR output from an automation control device or the included Gefen EXT-RMT-EXTIRN IR Extender to the IR In/Ext port on the Receiver, and connect an IR Emitter to the IR Out port on the Sender unit and attach it to the IR Sensor window of the source. To control devices at the viewing location (such as the display) via IR from the source side, use the IR In/Ext port on the Sender side and the IR Out connection on the Receiver side. Connect the Sender and the Receiver units together using a CAT-5e or better cable. Connect the locking power supply to either the Sender or the Receiver unit and plug it into an electrical outlet. Only one of the units needs an external power supply. The other unit will be powered through the CAT-5 cable. Power up all associated equipment.

Note: Shielded (STP) CAT-5e or CAT-6 is recommended. Unshielded (UTP) CAT-5e or CAT-6 may be acceptable depending on cable quality but is not the best choice. Care should always be given to keep these cables away from power lines and other sources of electromagnetic interference.

Features*

- Extends 4K Ultra HD (3840 x 2160 @ 60Hz, 4:2:0 or @ 30Hz, 4:4:4), Ethernet, RS-232, and Bi-Directional IR over a single CAT-5e cable up to 330 feet/100 meters (8-bit color)
- Extends 4K Cinema (DCI) (4096 x 2160 @ 24 or 30Hz 4:4:4), Ethernet, RS-232, and Bi-Directional IR over a single CAT-5e cable up to 330 feet/100 meters (8-bit color)
- Extends HDMI at 1080p Full HD, Ethernet, RS-232, and Bi-Directional IR over a single CAT-5e cable up to 330 feet/100 meters (up to 12-bit Deep Color)
- Extends HDMI at 1080p Full HD, Ethernet, RS-232, and Bi-Directional IR over a single CAT-5e cable up to 495 feet/150 meters (8-bit color)
- HDMI Features Supported:
 - HDMI 2.0
 - HDCP 2.2 and 1.4
 - 12-bit Deep Color
 - LPCM 7.1 audio, Dolby® TrueHD, and DTS-HD Master Audio™ pass-through
 - 3DTV pass-through
 - CEC pass-through
 - Lip Sync pass-through
- RS-232 Extension
- IR extension from Sender to Receiver and from Receiver to Sender
- Gefen Bi-Directional POL feature provides power to the Sender or the Receiver unit over the link cable - only one side needs external power
- Uses the Gefen implementation of HDBaseT™ technology
- Advanced EDID Management
- Firmware upgradable via RS-232
- Locking power connector
- Surface mountable

Specifications*

- Maximum Pixel Clock: 300 MHz
- Video Input Connector (Sender): (1) HDMI Type A 19-pin, female, locking
- Video Output Connector (Receiver): (1) HDMI Type A 19-pin, female, locking
- Link Connector (Sender/Receiver): (1) RJ-45, shielded
- RS-232 port (Sender): (1) 3-pin Phoenix - DB-9 adaptor cable included
- RS-232 port (Receiver): (1) 3-pin Phoenix - DB-9 adaptor cable included
- IR Ext/In port (Sender/Receiver): (1) 3.5mm mini-stereo jack
- IR Extender type: EXT-RMT-EXTIRN
- IR Out port (Sender/Receiver): (1) 3.5mm mini-mono jack
- Power/Link Indicator LED (Sender/Receiver): (1) Bi-color: Blue/Green
- Power Supply: (1) 24V DC, locking
- Power Consumption (Sender and Receiver combined): 12W maximum
- Operating Temperature: +32 to +113 °F (0 to +45 °C)
- Operating Humidity: 5% to 90% RH, non-condensing
- Storage Temperature: -4 to +185 °F (-20 to +85 °C)
- Storage Humidity: 0% to 95% RH, non-condensing
- MTBF: 50000 hours
- Dimensions (W x H x D, Sender/Receiver): 4.3" x 1" x 3.2" (110mm x 26mm x 85mm)
- Net Weight (Sender/Receiver): 0.4 lbs (0.2 kg) each
- Shipping Weight: 3.0 lbs. (1.4 kg)





- CAT-5 CABLE**
- HDMI CABLE**
- RS-232 CABLE**
- IR IN**
- IR OUT**

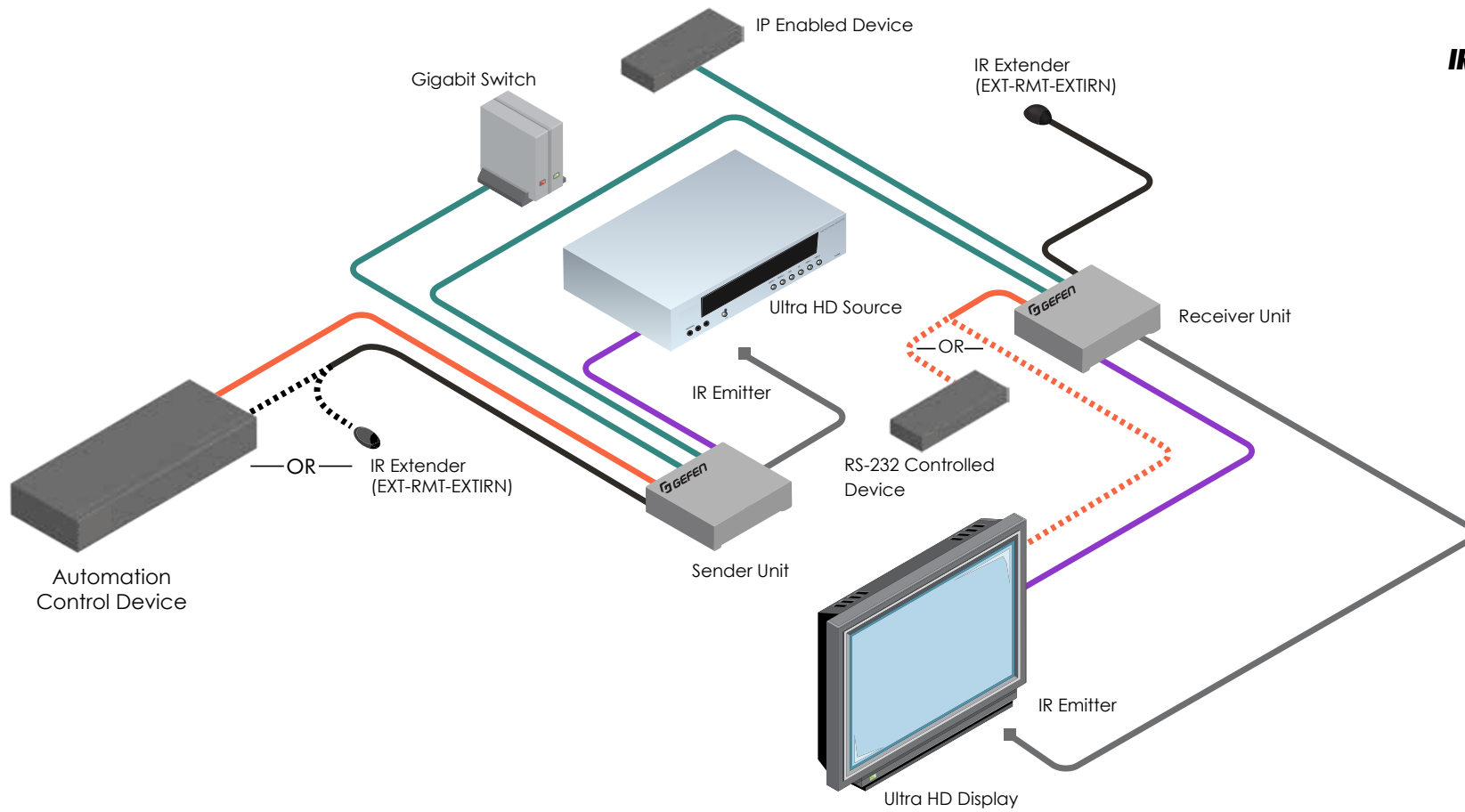

EXT-UHD-CAT5-ELRPOL

HDBaseT Extender for HDMI with Bi-Directional IR (IN/OUT) and POL

HDMI[®] 2.0

4K ULTRA HD
60Hz, 4:2:0

4K CINEMA
DCI, 4096 x 2160

HDCP 2.2



GTB-HDBT-POL-BLK

HDBaseT Extender for HDMI using one CAT-5e or CAT-6 cable up to 230 feet (70 meters)

The GTB-HDBT-POL uses Gefen's implementation of the HDBaseT™ technology to extend HDMI at resolutions up to 4K Ultra HD 60 Hz 4:2:0 and 4K DCI (Cinema), along with 7.1 channels of HBR (High Bit Rate) lossless digital audio. Extension range at 1080p Full HD is up to 230 feet (70 meters) using one CAT-6 cable or up to 198 feet (60 meters) using one CAT-5e. This product provides 2-way IR extension between the Sender and the Receiver unit, allowing IR communications between the source and the viewing location. 2-way IR can be used to control A/V sources placed near the Sender unit and to send automation commands to the display or any other device placed near the Receiver unit. Gefen POL (Power Over Line) technology powers the Receiver unit using the same cable that extends the HDMI signal. This feature eliminates the need for an external power supply for the Receiver unit and simplifies installation.

How It Works

Connect the Sender unit to the Hi-Def source using an HDMI cable. Use another HDMI cable to connect the Receiver unit to the HDTV display. Connect a single CAT-6 cable up to 230 feet (70 meters) or CAT-5e cable up to 198 feet (60 meters) between the Sender and Receiver units. Connect the included 24V DC power supply in to the Sender unit and plug the power supply to an available electrical outlet. Power to the Receiver unit is delivered from the Sender unit over the CAT-5e/6 cable using Gefen POL technology. To control the Hi-Def source from the display location, connect an IR Extender (Gefen part no. EXT-RMT-EXTIRC) to the Ext IR connector on the Receiver unit. Connect an IR emitter (Gefen part no. GTB-IREMIT) to the IR Out of the Sender unit and place the IR emitter over the IR sensor of the Hi-Def source. Point the IR remote at the IR Extender to control the Hi-Def source. For IR control of a device placed near the Receiver unit (such as the display), connect the IR output from an automation device (such as the Gefen PACS or Mini PACS) to the IR In connector on the Sender unit. Connect an IR emitter (Gefen part no. GTB-IREMIT) to the IR Out on the Receiver unit and attach the IR emitter to the IR sensor of the device being controlled.



Features*

- Extends 4K Ultra HD (3840 x 2160 @ 60Hz 4:2:0, or 30Hz, 4:4:4) and Bi-Directional IR up to 130 feet (40 meters) over a single CAT-5e or CAT-6 cable (8-bit color)
- Extends 4K Ultra HD (4096 x 2160 @ 24 or 30Hz 4:4:4) and Bi-Directional IR up to 130 feet (40 meters) over a single CAT-5e or CAT-6 cable
- Extends HDMI at 1080p Full HD and Bi-Directional IR up to 230 feet (70 meters) over a single CAT-6 cable, or up to 198 feet (60 meters) over CAT-5e
- HDMI Features Supported:
 - HDMI 2.0
 - HDCP 2.2 and 1.4
 - 12-bit Deep Color
 - LPCM 7.1 audio, Dolby® TrueHD, Dolby Digital® Plus, and DTS-HD® Master Audio™
 - 3DTV pass-through
 - CEC pass-through
 - Lip Sync pass-through
- Bi-Directional IR extension
- Gefen POL feature provides power to the Receiver unit over the CAT-5e
- Uses HDBaseT™ technology
- Locking power connector
- Easy surface mounting

Specifications*

- Maximum Pixel Clock: 300 MHz
- Video Input Connector (Sender): (1) HDMI Type A 19-pin, female, locking
- Video Output Connector (Receiver): (1) HDMI Type A 19-pin, female, locking
- Link Connectors (Sender/Receiver): (1) RJ-45, shielded
- Power/HDCP Indicator LED: Bi-color: Blue/Amber
- IR Extender port (Receiver): 3.5mm mini-stereo jack
- IR Out port (Sender / Receiver): 3.5mm mini-mono jack
- IR In port (Sender): 3.5mm mini-mono jack
- Power Supply: (1) 24V DC, locking
- Power Consumption: 24W (max.)
- Dimensions (W x H x D) (Sender / Receiver): 4.3" x 1" x 3.2" (110mm x 26mm x 80mm)
- Shipping Weight: 4 lbs. (1.8 kg)



CAT-5e (or better) CABLE  (Up To 230 FT)
HDMI CABLE 
IR 

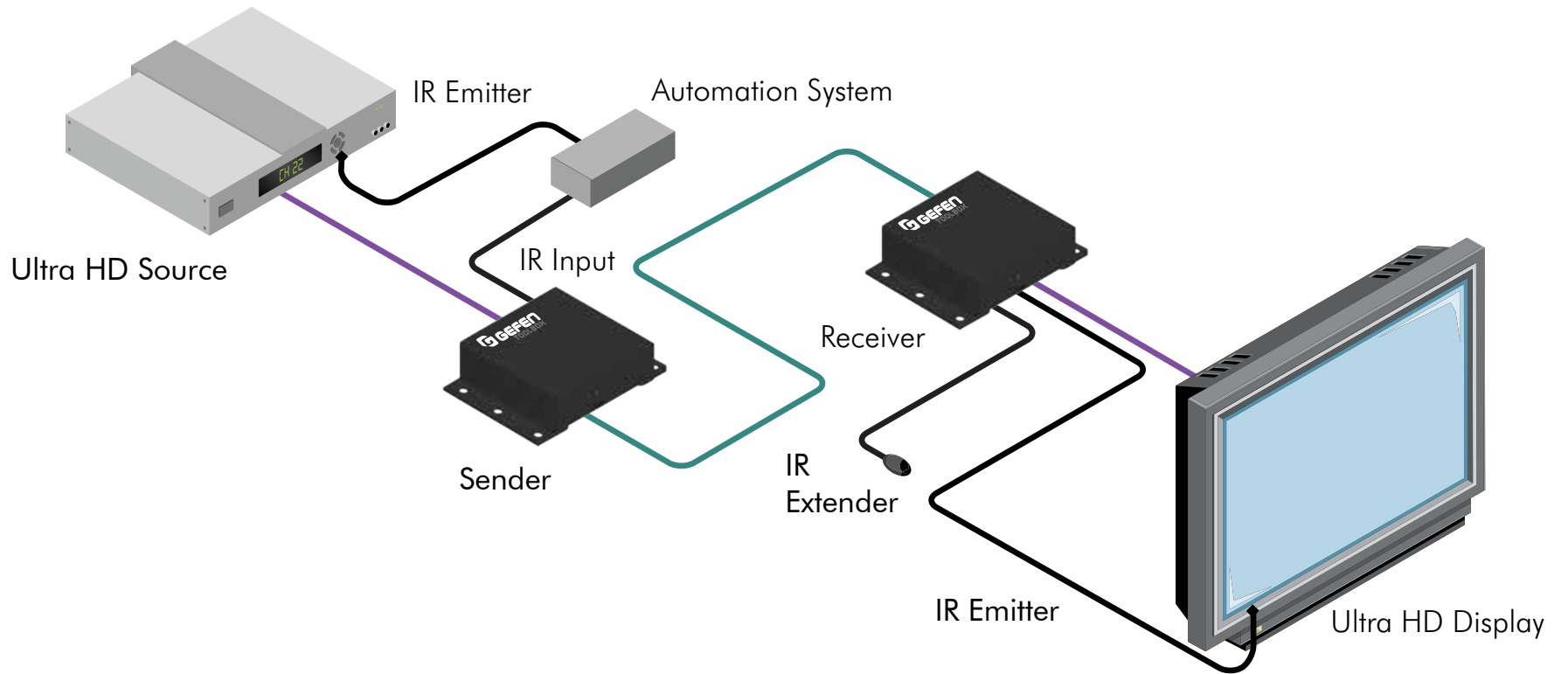

GTB-HDBT-POL-BLK



4K Ultra HD Extender for HDMI with RS-232, Bi-Directional IR, and POL



GTB-UHD2IRS-ELRPOL-BLK

HDMI[®] 2.0

4K ULTRA HD
60Hz, 4:2:0



HDCP 2.2

Extend HDMI, RS-232, and 2-way IR over one CAT-5e cable, up to 495 feet (150 meters)

The GefenToolBox 4K Ultra HD ELR Extender for HDMI with POL uses Gefen's implementation of the HDBaseT™ technology to extend HDMI up to 495 feet (150 meters) using one CAT-5e cable. Resolutions up to 4K Ultra HD with 7.1 channels of HBR (High Bit Rate) lossless digital audio are supported up to 330 feet (100 meters). This product provides RS-232 and 2-way IR extension between the Sender and the Receiver units, allowing the transfer of IR commands and RS-232 communications between two remote locations. RS-232 and Bi-Directional IR can be used to control A/V sources placed near the Sender unit and to send automation commands to the display or any other device placed near the Receiver unit. Gefen POL (Power Over Line) technology powers the Receiver unit using the same cable that extends the HDMI signal from the Sender unit. This feature eliminates the need for an external power supply for the Receiver unit and simplifies installation.

How It Works

Connect the Sender unit to a Hi-Def source using the included HDMI cable. Use another HDMI cable to connect the Receiver unit to a display. Connect a single CAT-5e or better cable between the Sender and Receiver units. To control the source from the display location via IR, connect the included IR extender (Gefen part no. EXT-RMT-EXTIRN) to the IR Ext connector on the Receiver unit. Connect the included IR emitter (Gefen part no. GTB-IREMIT) to the IR Out port of the Sender unit and place the IR emitter over the IR sensor of the source. Point the IR remote at the IR extender to control the source. For IR control of a device placed near the Receiver unit (such as the display), connect the IR output from an automation control device to the IR In connector on the Sender unit. Connect an IR emitter (Gefen part no. EXT-IREMIT) to the IR Out port on the Receiver unit and attach the IR emitter to the IR sensor of the device being controlled. To extend RS-232 between the local and remote locations, connect the included male-to-female DB-9 cable from the Sender to an automation control device, and connect another DB-9 cable of the same type from the Receiver unit to the device to be controlled. Connect the included 24V DC power supply to the Sender unit and plug it into an available electrical outlet. Power to the Receiver unit is delivered from the Sender unit over the CAT-5e cable using Gefen POL technology. Power on all associated equipment.

Note: Shielded (STP) CAT-5e or CAT-6 is recommended. Unshielded (UTP) CAT-5e or CAT-6 may be acceptable depending on cable quality but is not the best choice. Care should always be given to keep these cables away from power lines and other sources of electromagnetic interference.

Features*

- Extends 4K Ultra HD (3840 x 2160 @ 60Hz, 4:2:0 or 30Hz, 4:4:4) RS-232, and Bi-Directional IR up to 330 feet (100 meters) over a single CAT-5e (8-bit color**)
- Extends 4K Cinema (DCI) (4096 x 2160 @ 24 or 30Hz 4:4:4), (8-bit color**), RS-232, and Bi-Directional IR over a single CAT-5e cable up to 330 feet/100 meters (8-bit color**)
- Extends HDMI at 1080p Full HD, RS-232, and Bi-Directional IR over a single CAT-5e cable up to 330 feet/100 meters (up to 12-bit Deep Color)
- Extends HDMI at 1080p Full HD, RS-232, and Bi-Directional IR over a single CAT-5e cable up to 495 feet/150 meters (8-bit color**)
- HDMI Features Supported:
 - HDMI 2.0
 - HDCP 2.2 and 1.4
 - 12-bit Deep Color
 - LPCM 7.1 audio, Dolby® TrueHD, and DTS-HD Master Audio™ pass-through
 - 3DTV pass-through
 - CEC pass-through
 - Lip Sync pass-through
- RS-232 Extension
- 2-way IR extension from Sender to Receiver and from Receiver to Sender
- Gefen POL feature provides power to the Receiver unit over the link cable
- Uses Gefen's implementation of HDBaseT™ technology
- EDID pass-through
- Locking power connector
- Surface mountable

** This product passes through the display's EDID to the source. If the display is capable of accepting Deep Color, the source must be manually configured to output 8-bit color.

Specifications*

- Maximum Pixel Clock: 300 MHz
- Maximum TMDS Clock: 300 MHz
- Video Input Connector (Sender): (1) HDMI Type A 19-pin, female, locking
- Video Output Connector (Receiver): (1) HDMI Type A 19-pin, female, locking
- Link Connector (Sender/Receiver): (1) RJ-45, shielded
- RS-232 port (Sender): (1) DB-9, female
- RS-232 port (Receiver): (1) DB-9, male
- IR Extender port (Receiver): (1) 3.5mm mini-stereo jack
- IR Extender type: EXT-RMT-EXTIRN
- IR Out port (Sender/Receiver): (1) 3.5mm mini-mono jack
- IR In port (Sender): (1) 3.5mm mini-mono jack
- Power/HDCP Indicator LED (Sender/Receiver): (1) Bi-color: Blue/Amber
- Power Supply: (1) 24V DC, locking
- Power Consumption: 10W maximum
- Operating Temperature: 0 to +50 °C
- Operating Humidity: +10 to +90%, Relative Humidity, non-condensing
- Storage Temperature: -20 to +85 °C
- Storage Humidity: 0 to +95%, Relative Humidity, non-condensing
- MTBF: 50000 hours
- Dimensions (W x H x D) (Sender / Receiver): 4.3" x 1" x 3.2" (110mm x 26mm x 80mm)
- Unit Weight (Sender/Receiver): 0.35 lbs. (0.2 kg)
- Shipping Weight: 2.6 lbs. (1.2 kg)



GEFEN TOOLBOX

- CAT-5e CABLE** (Up to 495 ft)
- HDMI CABLE**
- IR**
- RS-232 CABLE**

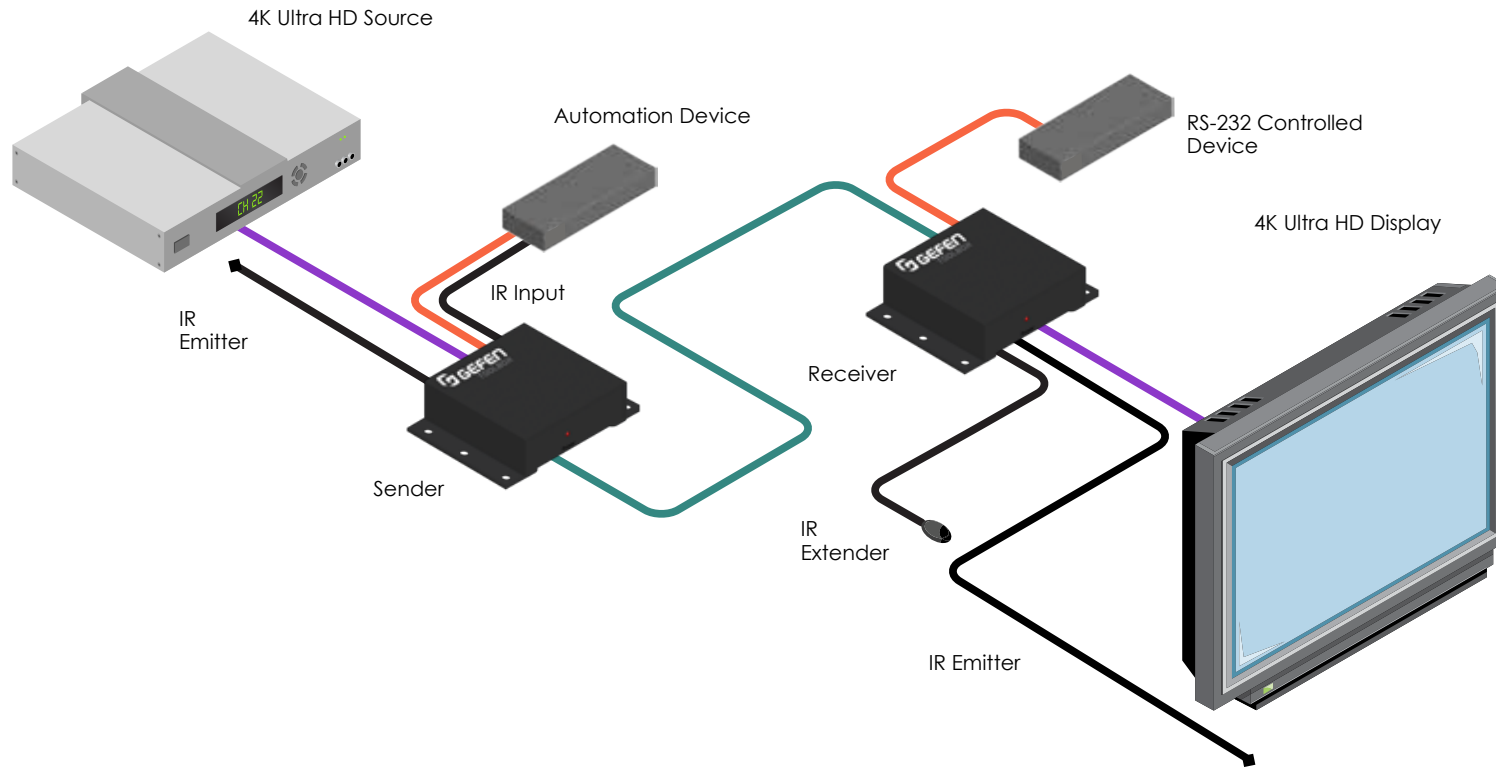

GTB-UHD2IRS-ELRPOL-BLK

Wireless Extenders for HDMI





Wireless Extender for HDMI 5 GHz Short Range up to 33 feet (10 meters)



**HDCP
COMPLIANT**

EXT-WHD-1080P-SR

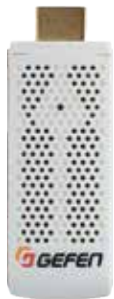

**1080P
PROGRESSIVE**



**AES128
Encryption**

**Up to 8
Senders**

The Wireless for HDMI 5 GHz SR (Short Range) Extender system sends high definition audio and video to any HDTV screen up to 33 feet (10 meters). It extends HDCP-compliant HDMI AV content from computers, game consoles, set-top boxes, Blu-ray players, and other AV sources to a remotely located display. HD resolutions up to 1080p Full HD, 7.1-channels of LPCM digital audio, and 5.1 channels of Dolby® or DTS® formats are supported. This wireless system is comprised of a Sender and a Receiver unit. The small "Stick" Sender connects directly to an HDMI port, and can be powered either from a powered USB port or from the included power supply. It is ideal for high-definition AV extension in a conference room or home theater installation that requires occasional connection of portable devices such as a presentation laptop computer or a video camera. The Receiver unit connects to a display with an HDMI input, using the supplied HDMI cable. It can be attached to a standard ¼"-20 camera tripod mount, wall mounted using two keyhole slots, or be placed on a shelf. Thanks to its small-size, low-profile, and the included wired IR Extender module, it can be hidden away behind the display or inside an equipment cabinet if needed. Up to eight Sender units can be accessed by the Receiver, one at a time, using its handheld remote control. While the Wireless for HDMI 5 GHz SR Extender system can transmit through obstacles and does not require line-of-sight placement of its transceivers, it is optimized for shorter distances that are typical of in-room use. For longer range extension, use the Gefen EXT-WHD-1080P-LR.

Features*

- Wireless extension of HDMI up to 33 feet (10 meters) **
- Supports resolutions up to 1080p Full HD, up to 7.1 channels of LPCM digital audio, and up to 5.1 channels of Dolby® and DTS® formats
- Transmits through obstacles – does not require line-of-sight
- HDMI Features Supported
 - 3DTV pass-through
 - HDCP pass-through
 - Lip Sync
- Uncompressed High Definition A/V from source to display
- Less than 1 frame latency
- AES 128 Encryption
- Compatible with legacy DVI displays
- Sender unit:
 - Small "Stick" connects directly to HDMI port
 - Powered from a USB port or included power supply
 - Ideal for temporary connection of mobile devices, laptops, cameras, etc.
- Receiver unit:
 - IR Extender module included for hidden installations
 - Small and compact form factor – can be installed behind the TV
 - Flexible mounting options: ¼"-20 thread, wall mounting, shelf placement
- Handheld IR remote for easy setup and operation
- Firmware update via Mini-USB port using Gefen Syner-G™ software
- WHDI 1.0, FCC Part 15, IC, and ETSI-compliant
- Additional Sender units (EXT-WHD-1080P-SR-TX) available separately ***

Specifications*

- Number & location of channels:
 - US model: 4: 5.19 GHz, 5.230 GHz, 5.755 GHz, 5.795 GHz
 - EU model: 2: 5.19 GHz, 5.230 GHz
- Maximum number of Senders to be linked: 8
- Video Input Connector (Sender): (1) HDMI Type A, 19-pin, male
- Video Output Connector (Receiver): (1) HDMI Type A, 19-pin, female
- Power Connector (Sender/Receiver): (1) USB Mini-B
- Power Supply (Sender): (1) 5V/2A DC with USB Type-A connector
- Power Supply (Receiver): (1) 5V/2A DC with USB Type-A connector
- Power Consumption (Sender/Receiver): 3W (max.) / 6W (max.)
- Operating Temperature: +32 to +104 °F (0 to +40 °C)
- Operating Humidity: +10 to +85%, Relative Humidity, non-condensing
- Storage Temperature: +14 to +140 °F (-10 to +60 °C)
- Storage Humidity: +5 to +90%, Relative Humidity, non-condensing
- Dimensions (W x H x D):
 - Sender Unit (including HDMI connector):
1.2" x 0.65" x 3.2" (30mm x 16mm x 80mm)
 - Receiver Unit (including feet):
3.8" x 1.4" x 3.8" (95mm x 35mm x 95mm)
- Net Unit Weight:
 - Sender Unit: 0.06 lbs (0.03 kg)
 - Receiver Unit: 0.3 lbs (0.15 kg)
- Shipping Weight:
 - EXT-WHD-1080P-SR: 1.9 lbs (0.9 kg)
 - EXT-WHD-1080P-SR-TX: 0.6 lbs (0.3 kg)

* Features and specifications are subject to change without notice.

** Obstructions such as walls and furniture, and RF interference could reduce reception distance. This product operates in the 5 GHz RF region, and features a specific number of channels. Other 5 GHz Transmitters including WiFi Routers may be occupying the same channels and may cause reception issues. See the User Manual for recommendations to help reduce interference.

*** Due to different transmission power levels, mixing of EXT-WHD-1080P-SR and EXT-WHD-1080P-LR Senders is not recommended. GTV-WHD-1080P-SR and GTV-WHD-1080P-LR Senders are not compatible with this product.



This product features firmware update using the Gefen Syner-G™ Software Suite, available for download at www.gefen.com

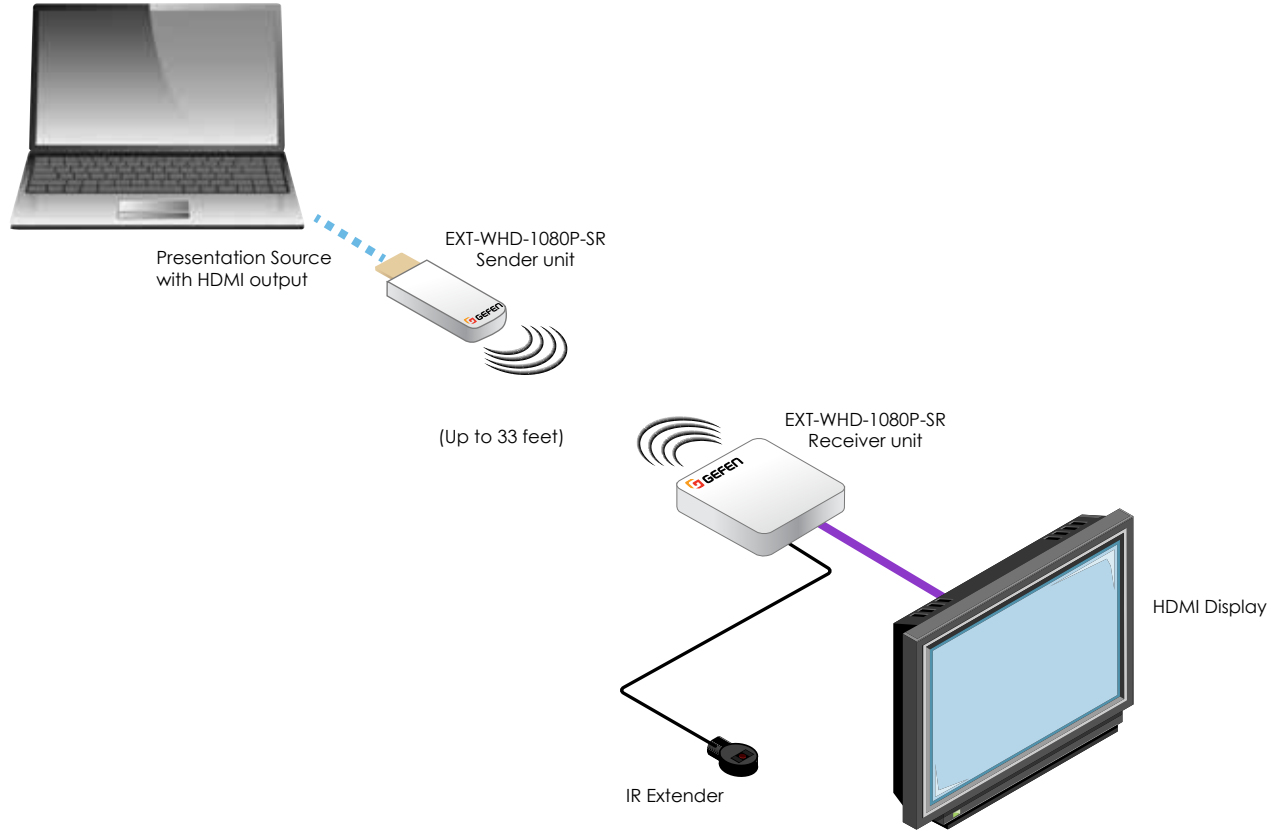

EXT-WHD-1080P-SR



Wireless Extender for HDMI 5 GHz Long Range up to 100 feet (30 meters)



CEC

AES128 Encryption

Up to 8 Senders

EXT-WHD-1080P-LR

The Wireless for HDMI 5 GHz LR (Long Range) Extender system sends high definition audio and video to any HDTV display up to 100 feet (30 meters). It extends HDCP-compliant HDMI AV content from computers, game consoles, set-top boxes, Blu-ray players, and other AV sources to a remotely located display. HD resolutions up to 1080p Full HD, 7.1-channels of LPCM digital audio, and 5.1 channels of Dolby® or DTS® formats are supported. This wireless system is comprised of a Sender and a Receiver unit. Both units can be attached to a standard 1/4"-20 camera tripod mount, wall mounted, or be placed on a shelf. The small and low-profile Receiver unit includes a wired IR Extender module, and can be hidden away behind the display or inside an equipment cabinet if needed. The Sender features two HDMI inputs and an HDMI output for connection to a local display. The end-user can select between the two HDMI sources by using the included handheld IR remote or by pressing the Input button on the Sender or the Receiver unit. The included IR emitter array can be connected to the Sender unit and attached to the IR sensor windows of the two Hi-Def sources, allowing full control of the source unit from another room simply by pointing the IR remote of the source at the Receiver unit. This wireless extender system is ideal for high-definition AV extension in a conference room, classroom, auditorium, home theater, and multiroom AV installations that feature multiple sources and two displays. Up to eight Sender units can be accessed by a Receiver, one at a time, using its handheld remote control. The Wireless for HDMI 5 GHz LR Extender system can transmit through walls and does not require line-of-sight placement of its transceivers.

Features*

- Wireless extension of HDMI up to 100 feet (30 meters) **
- Supports resolutions up to 1080p Full HD, up to 7.1 channels of LPCM digital audio, and up to 5.1 channels of Dolby® and DTS® formats
- Transmits through obstacles – does not require line-of-sight
- Long Range performance makes it ideal for multi-room use
- IR Back Channel for source control with carrier frequency selector
- HDMI Features Supported
 - CEC
 - 12-bit Deep Color
 - 3DTV pass-through
 - HDCP pass-through
 - Lip Sync
- Uncompressed High Definition A/V from source to display
- Less than 1 frame latency
- AES 128 Encryption
- Compatible with legacy DVI displays
- Sender unit:
 - 2 HDMI Inputs
 - Local HDMI "Mirrored" Output
 - IR Output port and included Emitter Array for source control
 - Ideal for use with 2 sources in a fixed home theater type installation
 - Flexible mounting options: 1/4"-20 thread, wall mounting, shelf placement
- Receiver unit:
 - IR Extender module included for hidden installations
 - Small and compact form factor – can be installed behind the TV
 - Flexible mounting options: 1/4"-20 thread, wall mounting, shelf placement
- Handheld IR remote for easy setup and operation
- Firmware update via Mini-USB port using Gefen Syner-G™ software
- WHDI 1.0, FCC Part 15, IC, and ETSI-compliant
- Additional Sender units (EXT-WHD-1080P-LR-TX) available separately ***

* Features and specifications are subject to change without notice.

** Obstructions such as walls and furniture, and RF interference could reduce reception distance. This product operates in the 5 GHz RF region, and features a specific number of channels. Other 5 GHz Transmitters including WiFi Routers may be occupying the same channels and may cause reception issues. See the User Manual for recommendations to help reduce interference.



*** Due to different transmission power levels, mixing of EXT-WHD-1080P-SR and EXT-WHD-1080P-LR Senders is not recommended. Furthermore, GTV-WHD-1080P-SR and GTV-WHD-1080P-LR Senders are not compatible with this product.

Specifications*

- Number & location of channels:
 - US model: 4: 5.19 GHz, 5.230 GHz, 5.755 GHz, 5.795 GHz
 - EU model: 2: 5.19 GHz, 5.230 GHz
- Maximum number of Senders to be linked: 8
- Video Input Connectors (Sender): (2) HDMI Type A, 19-pin, female
- Video Output Connector (Sender): (1) HDMI Type A, 19-pin, female
- Video Output Connector (Receiver): (1) HDMI Type A, 19-pin, female
- Power Connector (Sender): (1) 3.5mm barrel-type DC jack
- Power Connector (Receiver): (1) USB Mini-B
- Power Supply (Sender): (1) 5V/2A DC with USB Type-A connector
- Power Supply (Receiver): (1) 5V/2A DC with USB Type-A connector
- Power Consumption (Sender/Receiver): 7W (max.) / 6W (max.)
- Operating Temperature: +32 to +104 °F (0 to +40 °C)
- Operating Humidity: +10 to +85%, Relative Humidity, non-condensing
- Storage Temperature: +14 to +140 °F (-10 to +60 °C)
- Storage Humidity: +5 to +90%, Relative Humidity, non-condensing
- Dimensions (W x H x D, including feet):
 - Sender Unit: 7.2" x 1.3" x 3.9" (182mm x 33mm x 98mm)
 - Receiver Unit: 3.8" x 1.4" x 3.8" (95mm x 35mm x 95mm)
- Net Unit Weight:
 - Sender Unit: 0.5 lbs (0.25 kg)
 - Receiver Unit: 0.3 lbs (0.15 kg)
- Shipping Weight:
 - EXT-WHD-1080P-LR: 2.6 lbs (1.2 kg)
 - EXT-WHD-1080P-LR-TX: 1.5 lbs (0.65 kg)



This product features firmware update using the Gefen Syner-G™ Software Suite, available for download at www.gefen.com

HDMI CABLE 
IR IN 
IR OUT 

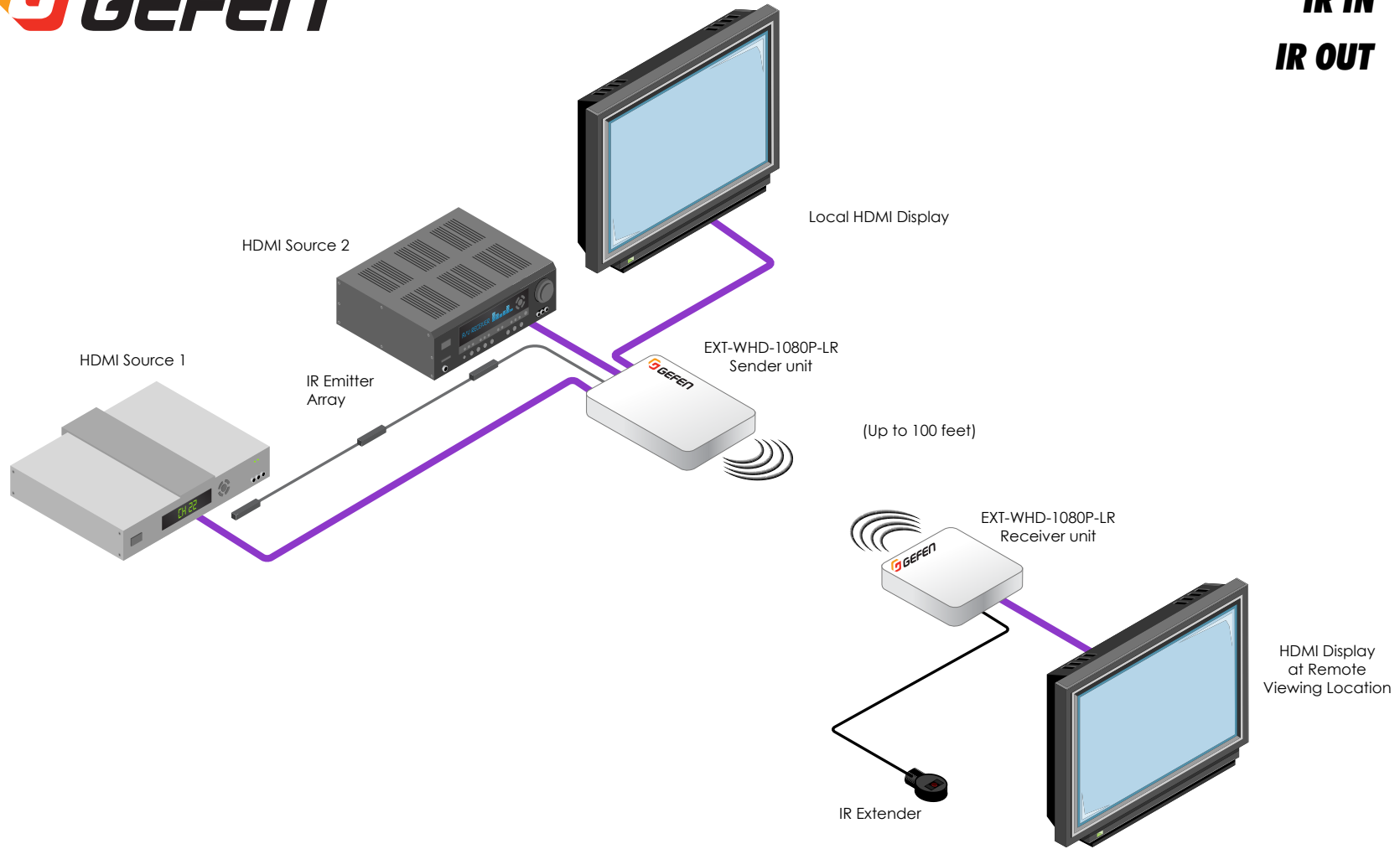

EXT-WHD-1080P-LR



Wireless Extender for HDMI 60 GHz



GTV-WHD-60G

Wirelessly extend HDMI video at 1080p Full HD with high resolution lossless 7.1 channel digital audio up to 33 feet (10 meters)

The GefenTV Wireless for HDMI 60 GHz extender system sends high definition audio and video to any HDTV display up to 33 feet (10 meters). It extends HDMI A/V content from computers, set-top boxes, and Blu-ray players to a remote HDCP-compliant Hi-Def display. This wireless product is comprised of small table-top Sender and Receiver units. It supports resolutions up to 1080p Full HD, 3DTV, CEC, and 7.1-channels of High Bit Rate (HBR) lossless digital audio such as Dolby® TrueHD, DTS-HD Master Audio™. The Wireless for HDMI 60 GHz is specifically designed to transmit within a room. Its signal will not penetrate through walls, facilitating interference-free operation of multiple units in adjacent venues and close proximity. Line-of-sight placement of transceivers, however, is not necessary. Thanks to its small form-factor, high performance, and near-zero latency, this product is ideal for high-definition A/V extension within a conference room or home theater installation.

How It Works

Connect the included HDMI cable from the Hi-Def source to the Sender unit. Connect the other included HDMI cable from the Receiver unit to the HDTV display. Connect the power supplies to both the Sender and Receiver units and to available electrical outlets. Power-up the source and the display. Press the power buttons on the Sender and Receiver units and make sure that they are on. A clear and vivid Hi-Def picture will appear on the screen and high resolution 7.1 channel audio will be played back through the audio system. CEC commands are also transferred seamlessly between connected HDMI components.

Features*

- Wireless extension of HDMI up to 33 feet (10 meters)
- Supports resolutions up to 1080p Full HD
- HDMI Features Supported
 - HDCP pass-through
 - 3DTV pass-through
 - CEC pass-through
 - Dolby® TrueHD, DTS-HD Master Audio™, and LPCM digital audio streams up to 7.1 channels
 - Lip Sync
- Uncompressed High Definition A/V from source to display
- Near zero latency (less than one frame)
- Specifically designed for in-room operation only.
- Operates in the uncluttered 60GHz frequency region, minimizing the chances of interference from household devices such as cordless phones or WiFi equipment.
- Field-upgradable via USB port

Specifications*

- Frequency Band Range: 60 GHz
- Video Input Connector (Sender): (1) HDMI Type A, 19-pin, female
- Video Output Connector (Receiver): (1) HDMI Type A, 19-pin, female
- USB Connector (Sender/Receiver): (1) Micro-B (firmware upgrade only)
- Link/Pair Button (Sender/Receiver): (1) Tact-type push-button switch
- Power Button (Sender/Receiver): (1) Latching push-button switch
- Power Indicator (Sender/Receiver): (1) LED, blue
- Power Supply (Sender/Receiver): 5V/2A DC
- Power Consumption (Sender/Receiver): 10W max.
- Dimensions (Sender/Receiver, W x H x D):
3.4" x 1.2" x 2.8" (85mm x 31mm x 72mm)
- Shipping Weight: 2.0 lbs. (0.9 kg)



HDCP COMPLIANT



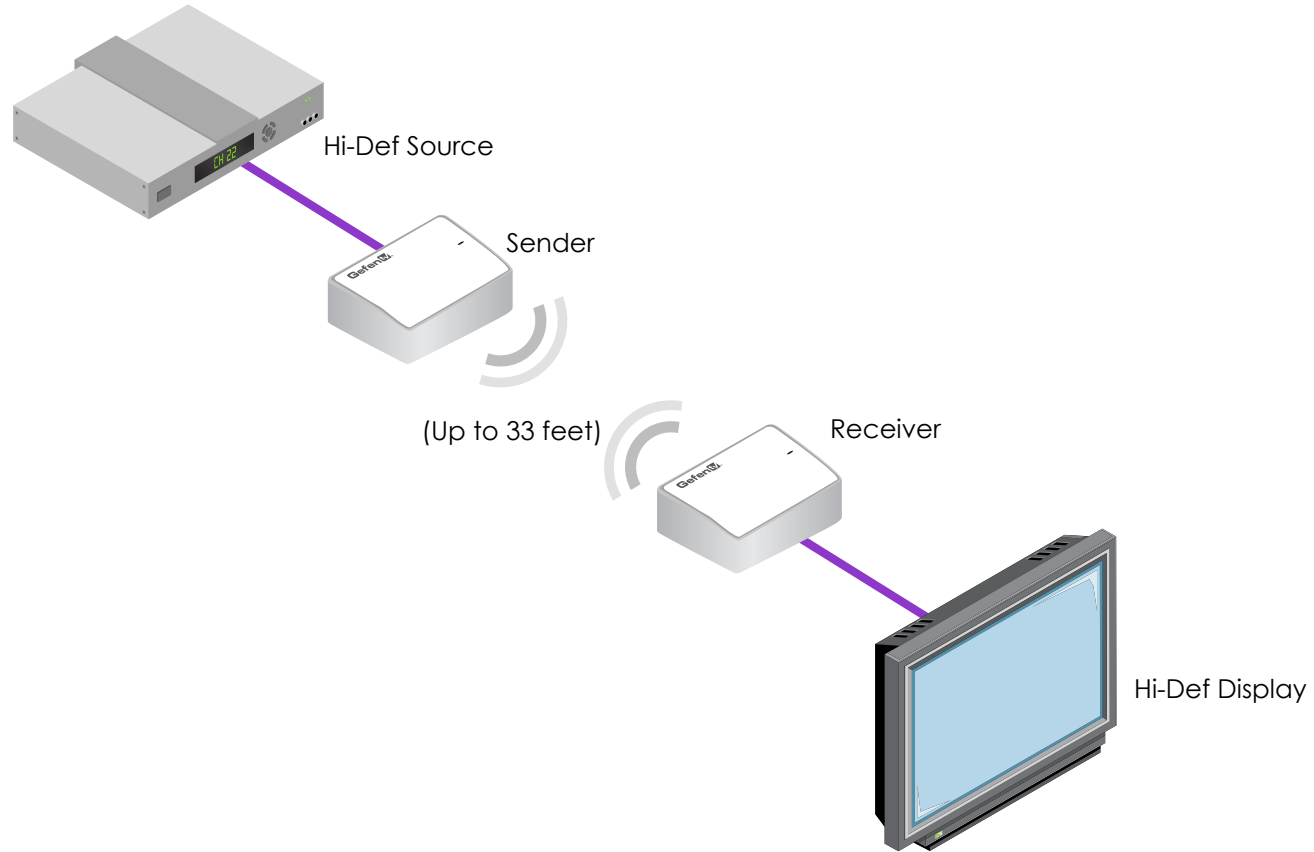

GTV-WHD-60G

Splitters



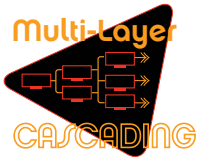

4K Ultra HD 1:2 Splitter for HDMI

The Gefen GTB-HD4K2K-142C routes one Ultra HD source to two 4K Ultra HD displays. This HDCP-compliant product has been specifically designed to support multiple layers of splitting/cascading for flawless performance in large video distribution and signage applications, supporting hundreds of displays. Resolutions supported include 4K Ultra HD (3860 x 2160 at 60 Hz, 4:2:0 color space), 4K DCI (4096 x 2160 at 24 and 30 Hz), 1080p Full HD, and 1920x1200 (WUXGA). Deep Color, 3D, and multichannel digital audio including 7.1 channels of LPCM and HBR (High Bit Rate) lossless formats are also passed through. This product features Fast Switching Technology (FST). FST is a Gefen firmware implementation for HDMI products. It eliminates the lengthy HDMI authentication process, and allows disconnecting, reconnecting, or powering down HDTV displays without any of these activities causing picture loss in other displays within the same distribution system. The choice between built-in and passed-through EDIDs, and the ability to configure the EDID for 2-channel or multichannel operation help customize your AV system to meet its operational requirements. The Gefen 1:2 Splitter is a high performance and capable choice for any small or large 4K video distribution system.

How It Works

The Ultra HD 4K Splitter is connected between the Ultra Hi-Def source and two Ultra HD displays. One or both of its outputs can alternatively be connected to another Gefen splitter to create a cascaded system that distributes HDMI to a larger number of displays. Each splitter should also be connected to an AC outlet using the included power supply. Once the source and the displays are turned on and power is applied to the splitter(s), the 4K picture will appear on all connected screens without any further set-up.



Features*

- Simultaneously displays an Ultra Hi-Def source on up to two Ultra HD displays
- Specifically designed to support 10 layers of splitting/cascading in large video distribution and signage applications, supporting hundreds of displays
- Supports resolutions up to 4K DCI (4096 x 2160 at 24 and 30 Hz), 4K Ultra HD (3860 x 2160 at 60Hz, 4:2:0 color space), 1080p Full HD, and 1920x1200 WUXGA
- Supports 12-bit Deep Color at 1080p
- 3DTV pass-through
- Lip Sync pass-through
- FST Technology speeds up HDCP authentication process
- EDID Management and Audio Mode selectors for rapid integration of source and displays
- Supports LPCM 7.1, Dolby® TrueHD, Dolby Digital® Plus, and DTS-HD Master Audio™
- Supports the use of DVI sources and DVI displays with HDMI-to-DVI adapters (not included)
- Field-upgradeable firmware using Mini-USB port
- Locking Power Supply
- Surface-mountable

Specifications*

- Maximum Pixel Clock: 300 MHz
- HDMI Input Connector: (1) Type A 19-pin female, locking
- HDMI Output Connectors: (2) Type A 19-pin female, locking
- USB Port: (1) Mini-B
- Power Indicator: (1) LED, blue
- FST Switch: (1) 2-position slide-type
- Audio Switch: (1) 2-position slide-type
- EDID Switch: (1) 2-position slide-type
- DC Power Connector: (1) Locking type
- Power Supply: 5V DC
- Power Consumption: 4 Watts (maximum)
- Operating Temperature: +32 to 104 °F (0 to +40 °C)
- Dimensions (W x H x D): 3.0" x 6.5" x 1.0" (76mm x 165mm x 26mm)
- Shipping Weight: 2.5 lbs. (1.1 kg)

4K ULTRA HD
60Hz, 4:2:0

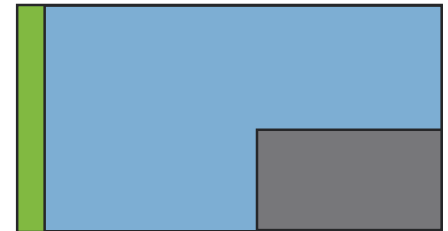

- 4K Cinema-DCI (4096 x 2160)
- 4K Ultra HD (3840 x 2160)
- 1080p Full HD (1920 x 1080)



GTB-HD4K2K-142C-BLK

GEFEN
TOOLBOX

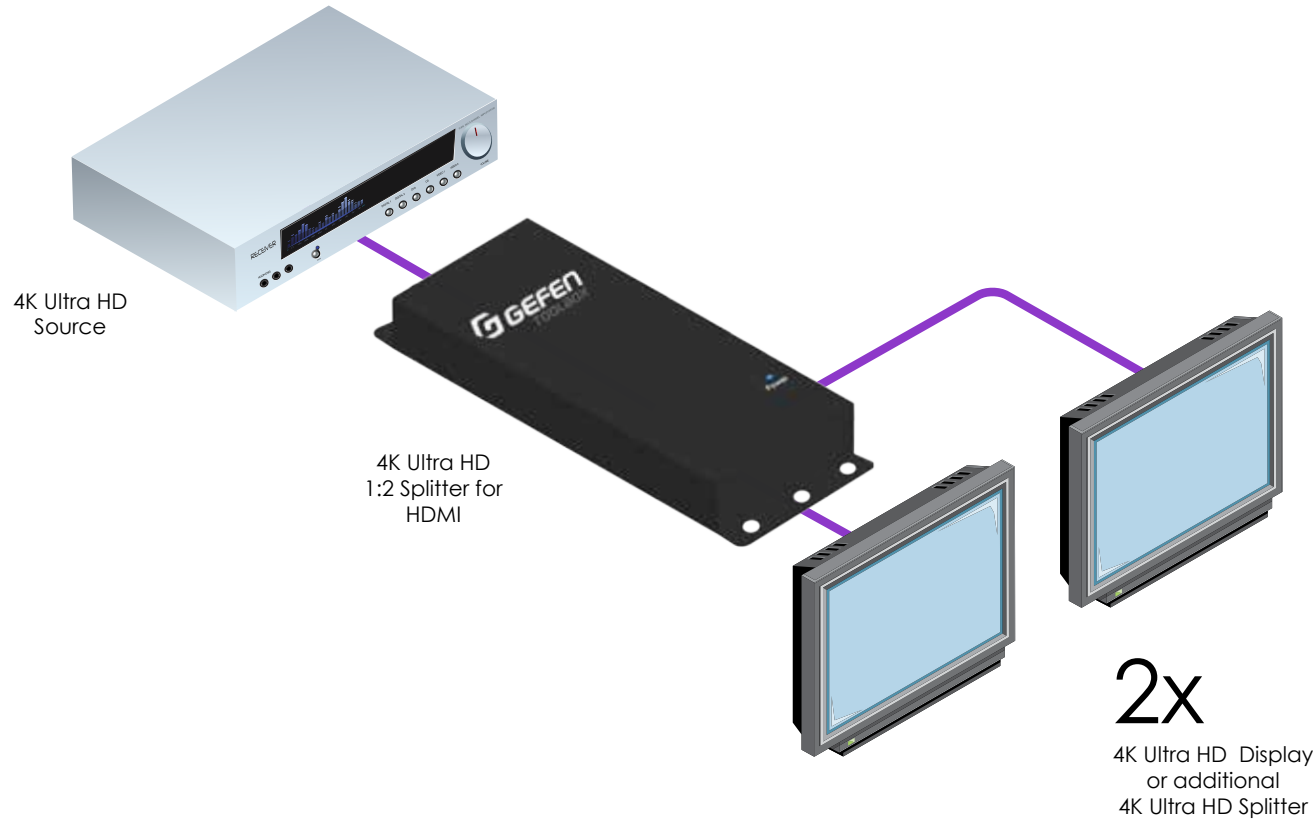

GTB-HD4K2K-142C-BLK

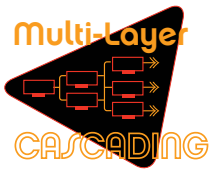

4K Ultra HD 1:4 Splitter for HDMI

The Gefen GTB-HD4K2K-144C routes one Ultra HD source to four 4K Ultra HD displays. This HDCP-compliant product has been specifically designed to support multiple layers of splitting/cascading for flawless performance in large video distribution and signage applications, supporting hundreds of displays. Resolutions supported include 4K Ultra HD (3860 x 2160 at 60 Hz, 4:2:0 color space), 4K DCI (4096 x 2160 at 24 and 34 Hz), 1080p Full HD, and 1920x1200 (WUXGA). Deep Color, 3D, and multichannel digital audio including 7.1 channels of LPCM and HBR (High Bit Rate) lossless formats are also passed through. This product features Fast Switching Technology (FST). FST is a Gefen firmware implementation for HDMI products. It eliminates the lengthy HDMI authentication process, and allows disconnecting, reconnecting, or powering down HDTV displays without any of these activities causing picture loss in other displays within the same distribution system. The choice between built-in and passed-through EDIDs, and the ability to configure the EDID for 2-channel or multichannel operation help customize your AV system to meet its operational requirements. The Gefen 1:4 Splitter is a high performance and capable choice for any small or large 4K video distribution system.

How It Works

The Ultra HD 4K Splitter is connected between the Ultra Hi-Def source and four Ultra HD displays. One or all of its outputs can alternatively be connected to another Gefen splitter to create a cascaded system that distributes HDMI to a larger number of displays. Each splitter should also be connected to an AC outlet using the included power supply. Once the source and the displays are turned on and power is applied to the splitter(s), the 4K picture will appear on all connected screens without any further set-up.

4K ULTRA HD
60Hz, 4:2:0

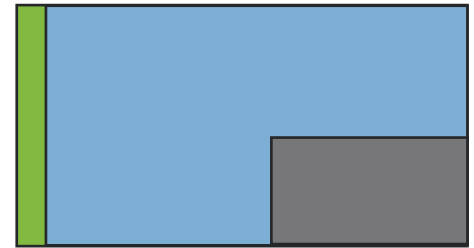

- 4K Cinema-DCI (4096 x 2160)
- 4K Ultra HD (3840 x 2160)
- 1080p Full HD (1920 x 1080)



Features*

- Simultaneously displays an Ultra Hi-Def source on up to four Ultra HD displays
- Specifically designed to support 10 layers of splitting/cascading in large video distribution and signage applications, supporting hundreds of displays
- Supports resolutions up to 4K DCI (4096 x 2160 at 24 and 30 Hz), 4K Ultra HD (3860 x 2160 at 60Hz, 4:2:0 color space), 1080p Full HD, and 1920x1200 WUXGA
- Supports 12-bit Deep Color at 1080p
- 3DTV pass-through
- Lip Sync pass-through
- FST Technology speeds up HDCP authentication process
- EDID Management and Audio Mode selectors for rapid integration of source and displays
- Supports LPCM 7.1, Dolby® TrueHD, Dolby Digital® Plus, and DTS-HD Master Audio™
- Supports the use of DVI sources and DVI displays with HDMI-to-DVI adapters (not included)
- Field-upgradeable firmware using Mini-USB port
- Locking Power Supply
- Surface-mountable

Specifications*

- Maximum Pixel Clock: 300 MHz
- HDMI Input Connector: (1) Type A 19-pin female, locking
- HDMI Output Connectors: (4) Type A 19-pin female, locking
- USB Port: (1) Mini-B
- Power Indicator: (1) LED, blue
- FST Switch: (1) 2-position slide-type
- Audio Switch: (1) 2-position slide-type
- EDID Switch: (1) 2-position slide-type
- DC Power Connector: (1) Locking type
- Power Supply: 5V DC
- Power Consumption: 5 Watts (max.)
- Operating Temperature: +32 to 104 °F (0 to +40 °C)
- Dimensions (W x H x D): 3.0" x 9.0" x 1.0" (76mm x 228mm x 26mm)
- Shipping Weight: 2.7 lbs. (1.2 kg)



GTB-HD4K2K-144C-BLK

GEFEN
TOOLBOX

HDMI CABLE 

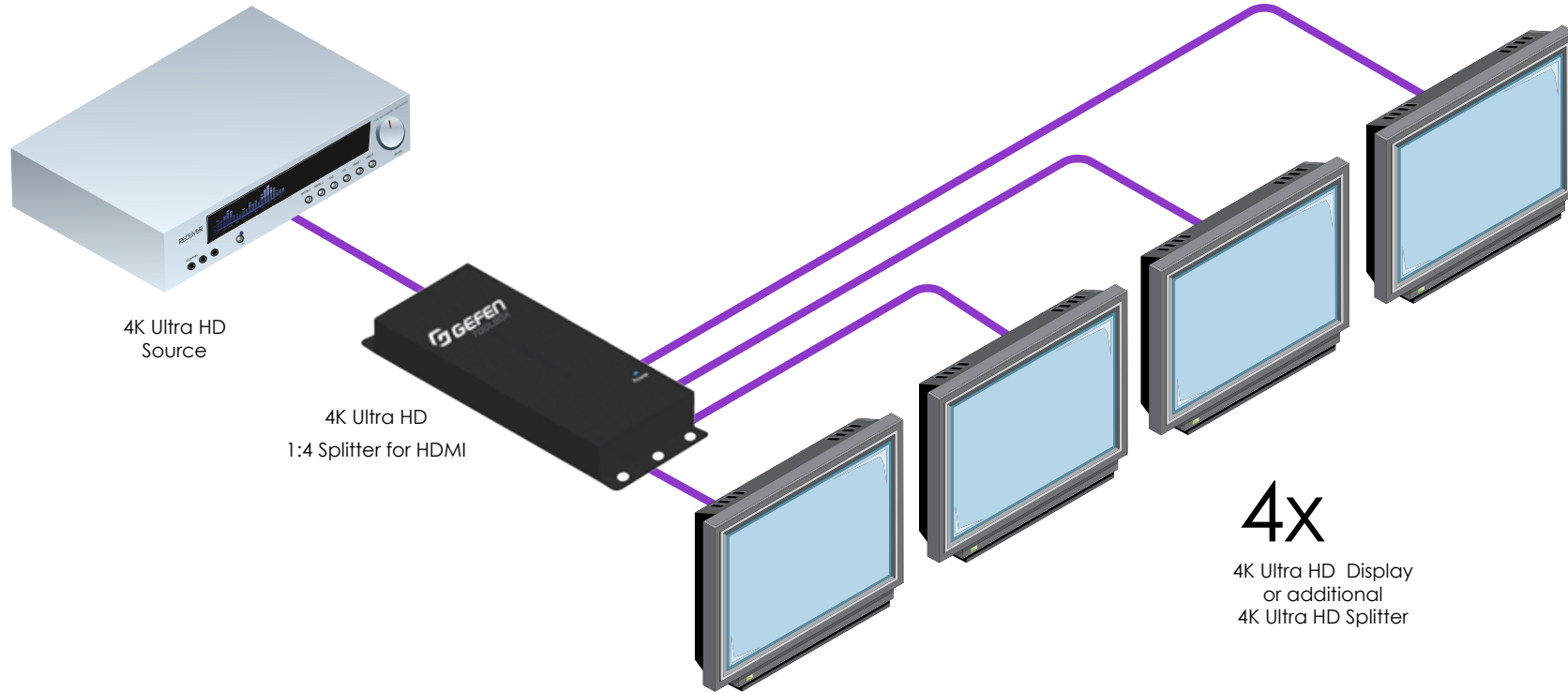

GTB-HD4K2K-144C-BLK

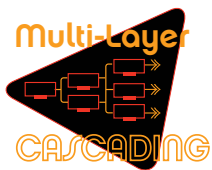

4K Ultra HD 1:8 Splitter for HDMI

The Gefen GTB-HD4K2K-148C routes one Ultra HD source to eight 4K Ultra HD displays. This HDCP-compliant product has been specifically designed to support 10 layers of splitting/cascading for flawless performance in large video distribution and signage applications, supporting hundreds of displays. Resolutions supported include 4K Ultra HD (3860 x 2160 at 60 Hz, 4:2:0 color space), 4K DCI (4096 x 2160 at 24 and 30 Hz), 1080p Full HD, and 1920x1200 (WUXGA). Deep Color, 3D, and multichannel digital audio including 7.1 channels of LPCM and HBR (High Bit Rate) lossless formats are also passed through. This product features Fast Switching Technology (FST). FST is a Gefen firmware implementation for HDMI products. It eliminates the lengthy HDMI authentication process, and allows disconnecting, reconnecting, or powering down HDTV displays without any of these activities causing picture loss in other displays within the same distribution system. The choice between built-in and passed-through EDIDs, and the ability to configure the EDID for 2-channel or multichannel operation help customize your AV system to meet its operational requirements. The Gefen 1:8 Splitter is the perfect choice for any small or large 4K video distribution system.



How It Works

The Ultra HD 4K Splitter is connected between the Ultra Hi-Def source and eight Ultra HD displays. One or all of its outputs can alternatively be connected to other Gefen splitters to create a cascaded system that distributes HDMI to a larger number of displays. Each splitter should also be connected to an AC outlet using the included power supply. Once the source and the displays are turned on and power is applied to the splitter(s), the 4K picture will appear on all connected screens without any further set-up.



4K ULTRA HD
60Hz, 4:2:0



-  4K Cinema-DCI (4096 x 2160)
-  4K Ultra HD (3840 x 2160)
-  1080p Full HD (1920 x 1080)

Features*

- Simultaneously displays an Ultra Hi-Def source on up to eight Ultra HD displays
- Specifically designed to support 10 layers of splitting/cascading in large video distribution and signage applications, supporting hundreds of displays
- Supports resolutions up to 4K DCI (4096 x 2160 at 24 and 30 Hz), 4K Ultra HD (3860 x 2160 at 60Hz, 4:2:0 color space), 1080p Full HD, and 1920x1200 WUXGA
- Supports 12-bit Deep Color at 1080p
- 3DTV pass-through
- Lip Sync pass-through
- FST Technology speeds up HDCP authentication process
- EDID Management and Audio Mode selectors for rapid integration of source and display
- Supports LPCM 7.1, Dolby® TrueHD, Dolby Digital® Plus, and DTS-HD Master Audio™
- Supports the use of DVI sources and DVI displays with HDMI-to-DVI adapters (not included)
- Field-upgradeable firmware using Mini-USB port
- Locking Power Supply
- Surface-mountable

Specifications*

- Maximum Pixel Clock: 300 MHz
- HDMI Input Connector: (1) Type A 19-pin female, locking
- HDMI Output Connectors: (8) Type A 19-pin female, locking
- USB Port: (1) Mini-B
- Power Indicator: (1) LED, blue
- FST Switch: (1) 2-position slide-type
- Audio Switch: (1) 2-position slide-type
- EDID Switch: (1) 2-position slide-type
- DC Power Connector: (1) Locking type
- Power Supply: 5V DC
- Power Consumption: 13 Watts (max.)
- Operating Temperature: +32 to 104 °F (0 to +40 °C)
- Dimensions (W x H x D): 4.5" x 10.4" x 1.0" (115mm x 264mm x 26mm)
- Shipping Weight: 3 lbs. (1.4 kg)



GTB-HD4K2K-148C-BLK

GEFEN
TOOLBOX

HDMI CABLE 

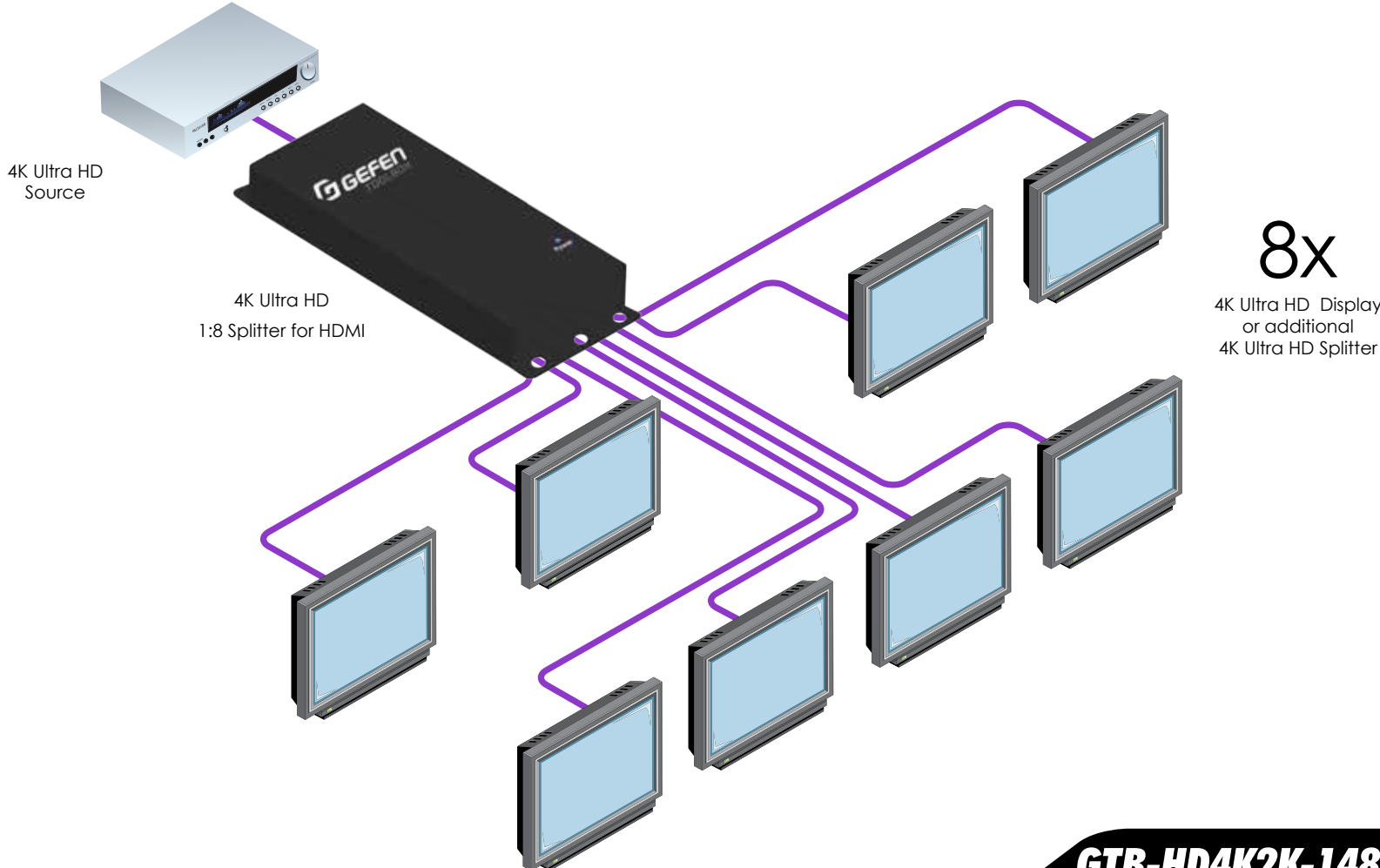

GTB-HD4K2K-148C-BLK

Scaler/Converters





3GSDI to HDMI Converter



EXT-3G-HD-C

Use an SDI source with an HDMI display or downstream equipment

The Gefen EXT-3G-HD-C converts audio and video from SDI to HDMI format, at resolutions up to 1080p Full HD. 3G-SDI, single link HD-SDI, and audio formats up to 8 channels of LPCM are supported. This product is fully compatible with the Gefen Syner-G™ software suite. The Gefen Syner-G™ is a powerful set of software tools specifically designed to help discover, configure/customize, manage, monitor, and upgrade Gefen products. The Gefen EXT-3G-HD-C's compact enclosure, while light enough to be held in place using double sided Velcro® tape, features an ISO standard 1/4-20 attachment provision as well as a detachable surface-mounting bracket. This, along with a flexible power input circuitry capable of accepting a wide range of DC voltages and a locking power supply connector, make the EXT-3G-HD-C ideal for cutting edge mobile A/V applications as well as high performance fixed installations.

How It Works

This product can be installed on camera gear via an industry-standard 1/4-20 attachment thread located on the bottom of the unit. It can also be surface-mounted using the included surface mounting bracket. The EXT-3G-HD-C is light and compact enough to be held in place using Velcro® if your particular installation does not allow for the two preferred methods of installation described above. Set the DIP switches as necessary. Connect an SDI cable between the input of the EXT-3G-HD-C and an SDI source. Connect the HDMI output of the Gefen converter to an HDMI display or other downstream equipment using a Gefen locking HDMI cable. Connect the included 12V DC power supply to the 3GSDI to HDMI Converter's power supply jack and to an available electrical outlet. To remove the power supply plug from the unit, disengage the lock by pulling back on its plastic sleeve. The power LED indicator will glow in blue to indicate that the unit is powered on. The HDMI Out LED indicator will glow in green to indicate that an active HDMI sink is present. Use the USB Mini-B port with Gefen Syner-G™ software suite for performing firmware updates. See the user manual for details.

Features*

- Converts SDI to HDMI
- Input resolutions up to 1080p60
- Output resolutions up to 1080p Full HD
- HDMI (YCbCr 4:4:4) or DVI (RGB 4:4:4) output modes
- Supports 3G-SDI Levels A and B, Single-Link HD-SDI, and SD-SDI
- Supports up to 10 bit color on input and output
- Up to LPCM 7.1 audio support
- Field configurable via DIP switch settings
- Mini USB port for use with Gefen Syner-G™ for in-field firmware updates
- Wide power supply operating range (6V to 24V DC)
- Locking power supply connector
- 1/4-20 industry-standard camera gear attachment thread on bottom
- Surface-mountable using the included detachable bracket

Specifications*

- Maximum Pixel Clock: 150 MHz
- Maximum TMDS Clock: 225 MHz
- Video Input Connector: (1) SDI BNC-type, female
- Video Output Connector: (1) HDMI Type A 19-pin, female, locking
- USB Connector: (1) Mini-B
- Configuration Switches: (5) DIP-type
- HDMI Indicator: (1) LED, green
- Power Indicator: (1) LED, blue
- Power Supply Connector: (1) 3-pin, locking
- Power Supply: 12V DC nominal (6V to 24V DC operating range)
- Power Consumption: 2W maximum
- Operating Temperature: +32 to +122 °F (0 to +50 °C)
- Operating Humidity: 5% to 90% RH, non-condensing
- Storage Temperature: -4 to +185 °F (-20 to +85 °C)
- Storage Humidity: 0% to 95% RH, non-condensing
- MTBF: 50000 hours
- Dimensions (excluding connectors, W x H x D):
2.9" x 1.2" x 2.3" (74mm x 30mm x 59mm)
- Net Unit Weight: 0.3 lbs (0.15 kg)

This product has been specifically designed for use with the Gefen Syner-G™ Software Suite, available for download at www.gefen.com. The Gefen Syner-G™ interfaces with the EXT-3G-HD-C via its USB Mini-B port and simplifies in-field firmware updates.





HDMI CABLE 
SDI CABLE 

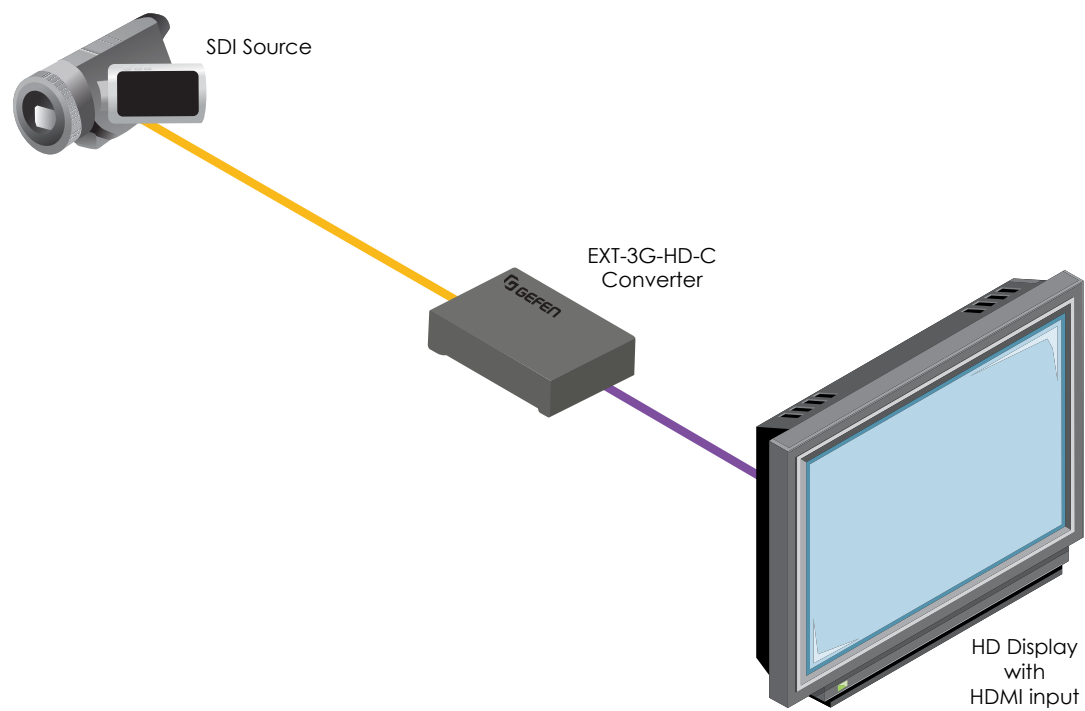

EXT-3G-HD-C



HDMI to 3GSDI Converter



EXT-HD-3G-C

Use an HDMI source with an SDI display or downstream equipment

The Gefen HD-3G-C converts audio and video from HDMI to 3G-SDI and single link HD-SDI. Resolutions up to 1080p Full HD and audio formats up to 8 channels of LPCM are supported. This product is fully compatible with the Gefen Syner-G™ software suite. The Gefen Syner-G™ is a powerful set of software tools specifically designed to help discover, configure/customize, manage, monitor, and upgrade Gefen products. The Gefen EXT-HD-3G-C's compact enclosure, while light enough to be held in place using double sided Velcro® tape, features an ISO standard 1/4-20 attachment provision as well as a detachable surface-mounting bracket. This, along with a flexible power input circuitry capable of accepting a wide range of DC voltages and a locking power supply connector, make the EXT-HD-3G-C ideal for cutting edge mobile A/V applications as well as high performance fixed installations.

How It Works

This product can be installed on camera gear via an industry-standard 1/4-20 attachment thread located on the bottom of the unit. It can also be surface-mounted using the included surface mounting bracket. The EXT-HD-3G-C is light and compact enough to be held in place using Velcro® if your particular installation does not allow for the two preferred methods of installation described above. Set the DIP switches as necessary. Connect an SDI cable between the output of the EXT-HD-3G-C and an SDI display or other downstream equipment. Connect the HDMI source to the HDMI input of the EXT-HD-3G-C using the included Locking HDMI cable. Connect the included 12V DC power supply to the 3GSDI to HDMI Converter's power supply jack and to an available electrical outlet. To remove the power supply plug from the unit, disengage the lock by pulling back on its plastic sleeve. The power LED indicator will glow in blue to indicate that the unit is powered on. The HDMI In LED indicator will glow in green to indicate that an active HDMI source is present. Use the USB Mini-B port with Gefen Syner-G™ software suite for EDID customization as well as performing firmware updates. See the user manual for details.

NOTE: The Gefen EXT-HD-3G-C is not compatible with HDCP encoded HDMI content. If the input signal is HDCP-encoded, there will be no SDI output.

Features*

- Converts HDMI to SDI
- Input resolutions up to 1920 x 1200 (WUXGA) and 1080p Full HD
- Output resolutions up to 1080p60
- Supports HDMI 12 bit color and SDI 10-bit color
- Supports Color Spaces: 4:4:4 (RGB and YCbCr) and 4:2:2 (YCbCr)
- Supports 3G-SDI Levels A and B
- Up to LPCM 7.1 audio support
- Field configurable via DIP switch settings or Gefen Syner-G™ software
- Gefen Syner-G™ simplifies in-field firmware updates and advanced EDID management
- Mini USB port for use with Gefen Syner-G™
- Wide power supply operating range (6V to 24V DC)
- Locking power supply connector
- 1/4-20 industry-standard camera gear attachment thread on bottom
- Surface-mountable using the included detachable bracket

Specifications*

- Maximum Pixel Clock: 150 MHz
- Maximum TMDS Clock: 225 MHz
- Video Input Connector: (1) HDMI Type A 19-pin, female, locking
- Video Output Connector: (1) SDI BNC-type, female
- USB Connector: (1) Mini-B
- Configuration Switches: (3) DIP-type
- HDMI Indicator: (1) LED, green
- Power Indicator: (1) LED, blue
- Power Supply Connector: (1) 3-pin, locking
- Power Supply: 12V DC nominal (6V to 24V DC operating range)
- Power Consumption: 3W maximum
- Operating Temperature: +32 to +122 °F (0 to +50 °C)
- Operating Humidity: 5% to 90% RH, non-condensing
- Storage Temperature: -4 to +185 °F (-20 to +85 °C)
- Storage Humidity: 0% to 95% RH, non-condensing
- MTBF: 50000 hours
- Dimensions (excluding connectors, W x H x D):
2.9" x 1.2" x 2.3" (74mm x 30mm x 59mm)
- Net Unit Weight: 0.3 lbs (0.15 kg)

This product has been specifically designed for use with the Gefen Syner-G™ Software Suite, available for download at www.gefen.com. In addition to all the configuration settings that are available via the DIP Switches, the Gefen Syner-G™ simplifies in-field firmware updates and provides the ability to configure this converter for custom EDID settings.

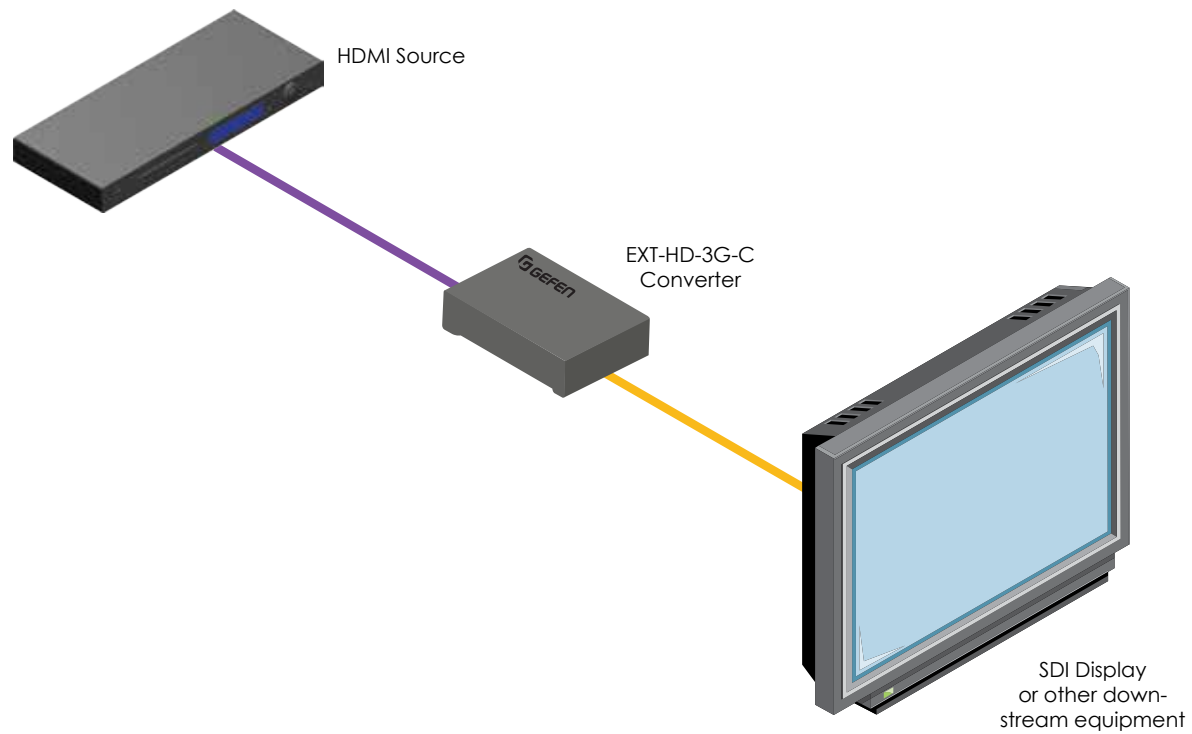

EXT-HD-3G-C



HDMI & VGA to 3GSDI Scaler/Converter



EXT-HDVGA-3G-SC



Switch video and audio from an HDMI and a VGA source, scale the picture, and output it to an SDI device

The Gefen HDVGA-3G-SC scales and converts video from an HDMI or a VGA source to SDI formats, including 3G-SDI and single link HD-SDI. It can also embed HDMI audio or analog L/R audio into the SDI stream. Video can be scaled up to 1080p Full HD. An intuitive and comprehensive on-screen display (OSD) menu allows easy set-up and control. This product can be configured and updated using the Gefen Syner-G™ software suite. The Gefen Syner-G™ is a powerful set of software tools specifically designed to help discover, configure/ customize, manage, monitor, and upgrade Gefen products. Wide power supply operating range of 6V to 24V DC offers installation flexibility for mobile use, in complex studio systems with a common power supply, and with remotely located power sources. A locking power supply connector, small footprint, and a surface-mountable enclosure facilitate easy and secure installation.

How It Works

Use the included HDMI and VGA cables to connect an HDMI source to the HDMI input and/or a VGA source to the VGA input. If you will be embedding analog L/R audio into the SDI stream, connect the included 3.5mm mini-stereo cable from the source to the L/R audio input. Connect an SDI display or other downstream equipment to the BNC video connector output. Connect the included 12V DC power supply to the unit and to an available electrical outlet. The power LED will glow in blue once the power supply is plugged in. Once the unit is powered-on, the HDMI and VGA buttons can be used to select the desired input. Once an input is selected, the corresponding LED will glow in green. To bring up the On-Screen Display (OSD), press the Menu button. Use the Up and Dn (down) buttons to navigate through the various functions of the OSD.

Features*

- Converts and scales HDMI and VGA and L/R analog audio to SDI
- Input resolutions up to 1920 x 1200 (WUXGA) and 1080p60
- Output resolutions up to 1080p60
- On-screen display (OSD) menu allows easy set-up and control
- Aspect Ratio Control: Full Screen, Panoramic, Letter/Pillar, Extract/Crop
- Test Pattern Generator for quick system configuration
- Embeds 2-channel analog stereo audio in SDI signal (VGA Input only)
- Up to LPCM 7.1 audio support (HDMI input only)
- Gefen Syner-G™ simplifies in-field firmware updates and advanced EDID management including custom input timings
- USB port for use with Gefen Syner-G™
- Wide power supply operating range (6V to 24V DC)
- Locking power supply connector
- Surface-mountable

Specifications*

- Maximum Pixel Clock - HDMI and VGA Inputs: 165 MHz
- Maximum Pixel Clock - SDI Output: 150 MHz
- Maximum TMDS Clock: 225 MHz
- Video Input Connectors: (1) HDMI: Type A 19-pin, female, locking
(1) VGA: HD-15, female
- Audio Input Connector: (1) 3.5mm mini-stereo jack
- Video Output Connector: (1) SDI, BNC-type, female
- USB Connector: (1) Mini-B
- Input Select/Menu/Navigation Switches: (3) tact-type
- HDMI Indicator: (1) LED, green
- VGA Indicator: (1) LED, green
- Power Indicator: (1) LED, blue
- Power Supply Connector: (1) 3-pin, locking
- Power Supply: 12V DC nominal (6V to 24V DC operating range)
- Power Consumption: 5W maximum
- Operating Temperature: +32 to +122 °F (0 to +50 °C)
- Operating Humidity: 5% to 90% RH, non-condensing
- Storage Temperature: -4 to +185 °F (-20 to +85 °C)
- Storage Humidity: 0% to 95% RH, non-condensing
- MTBF: 50000 hours
- Dimensions (excluding connectors, W x H x D):
5.6" x 1.2" x 3.7" (141 mm x 30mm x 93mm)
- Net Unit Weight: 0.5 lbs (0.23 kg)

 This product has been specifically designed for use with the Gefen Syner-G™ Software Suite, available for download at www.gefen.com

In addition to all the configuration settings that are available from the On Screen Display, the Gefen Syner-G™ simplifies in-field firmware updates and provides the ability to configure this scaler/converter for custom input timings.





VGA CABLE 

HDMI CABLE 

SDI CABLE 

MINI STEREO AUDIO CABLE 

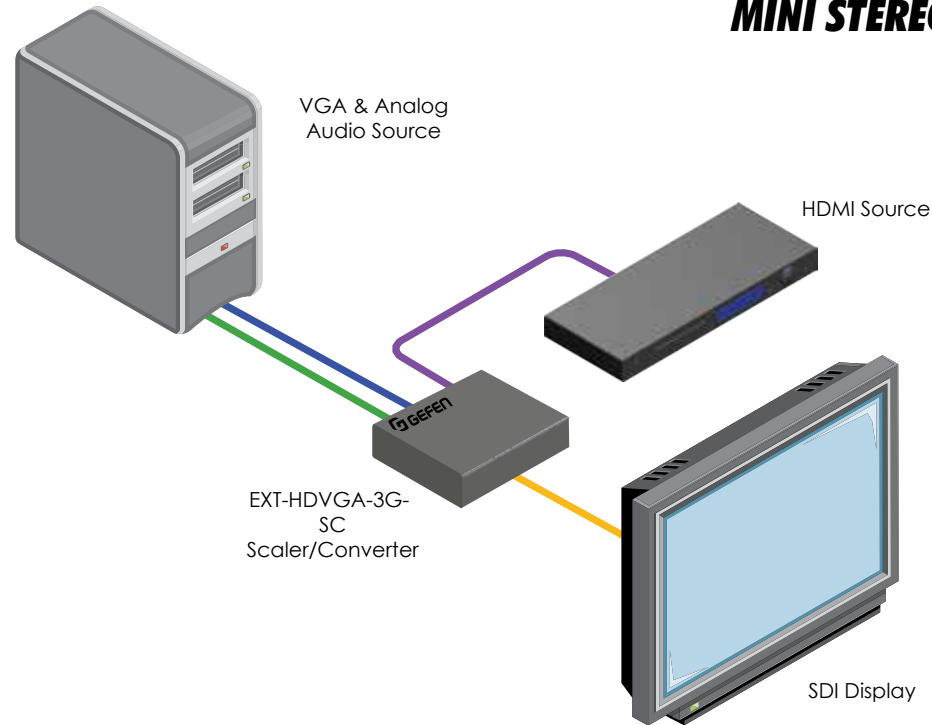

EXT-HDVGA-3G-SC



VGA to DVI Scaler/Converter



EXT-VGA-DVI-SC



Scale and convert video from a VGA source for use with a DVI Display

The Gefen EXT-VGA-DVI-SC scales and converts video from a VGA source to a DVI output. Video can be scaled up to 1080p Full HD and 1920 x 1200 (WUXGA). An intuitive and comprehensive on-screen display (OSD) menu allows easy set-up and control. This product can be configured and updated using the Gefen Syner-G™ software suite. The Gefen Syner-G™ is a powerful set of software tools specifically designed to help discover, configure/customize, manage, monitor, and upgrade Gefen products. Wide power supply operating range of 6V to 24V DC offers installation flexibility for mobile use, in complex studio systems with a common power supply, and with remotely located power sources. A locking power supply connector, small footprint, and a surface-mountable enclosure facilitate easy and secure installation.

How It Works

Use the included VGA cable to connect a VGA source to the VGA input. Use a DVI cable to connect a DVI display to the DVI output. Connect the included 12V DC power supply to the unit and to an available electrical outlet. The power LED will glow in blue once the power supply is plugged in. Once the unit is connected, powered on, and displaying video, press the Menu button to bring up the On-Screen Display (OSD). The Up and Dn (down) buttons are used to navigate through the various functions of the OSD.

Features*

- Converts and scales VGA to DVI
- Input resolutions up to 1920 x 1200 (WUXGA)
- Output resolutions up to 1080p60 and 1920 x 1200 (WUXGA)
- On-screen display (OSD) menu allows easy set-up and control
- Aspect Ratio Control: Full Screen, Panoramic, Letter/Pillar, Extract/Crop
- Test Pattern Generator for quick system configuration
- Gefen Syner-G™ simplifies in-field firmware updates and advanced EDID management including custom input timings
- USB port for use with Gefen Syner-G™
- Wide power supply operating range (6V to 24V DC)
- Locking power supply connector
- Surface mountable

Specifications*

- Maximum Pixel Clock: 165 MHz
- Maximum TMDS Clock: 165 MHz
- Video Input Connector: (1) VGA HD-15, female
- Video Output Connectors: (1) DVI-I, 29-pin, female (digital only)
- USB Connector: (1) Mini-B
- Menu/Navigation Switches: (3) tact-type
- Power Indicator: (1) LED, blue
- Power Supply Connector: (1) 3-pin, locking
- Power Supply: 12V DC nominal (6V to 24V DC operating range)
- Power Consumption: 2W maximum
- Operating Temperature: +32 to +122 °F (0 to +50 °C)
- Operating Humidity: 5% to 90% RH, non-condensing
- Storage Temperature: -4 to +185 °F (-20 to +85 °C)
- Storage Humidity: 0% to 95% RH, non-condensing
- MTBF: 50000 hours
- Dimensions (excluding connectors, W x H x D):
4.9" x 1" x 3.2" (123mm x 26mm x 82mm)
- Unit Weight: 0.4 lbs. (0.2kg)



This product has been specifically designed for use with the Gefen Syner-G™ Software Suite, available for download at www.gefen.com

In addition to all the configuration settings that are available from the On Screen Display, the Gefen Syner-G™ simplifies in-field firmware updates and provides the ability to configure this scaler/converter for custom input timings.



1080P
PROGRESSIVE



VGA CABLE 
DVI CABLE 

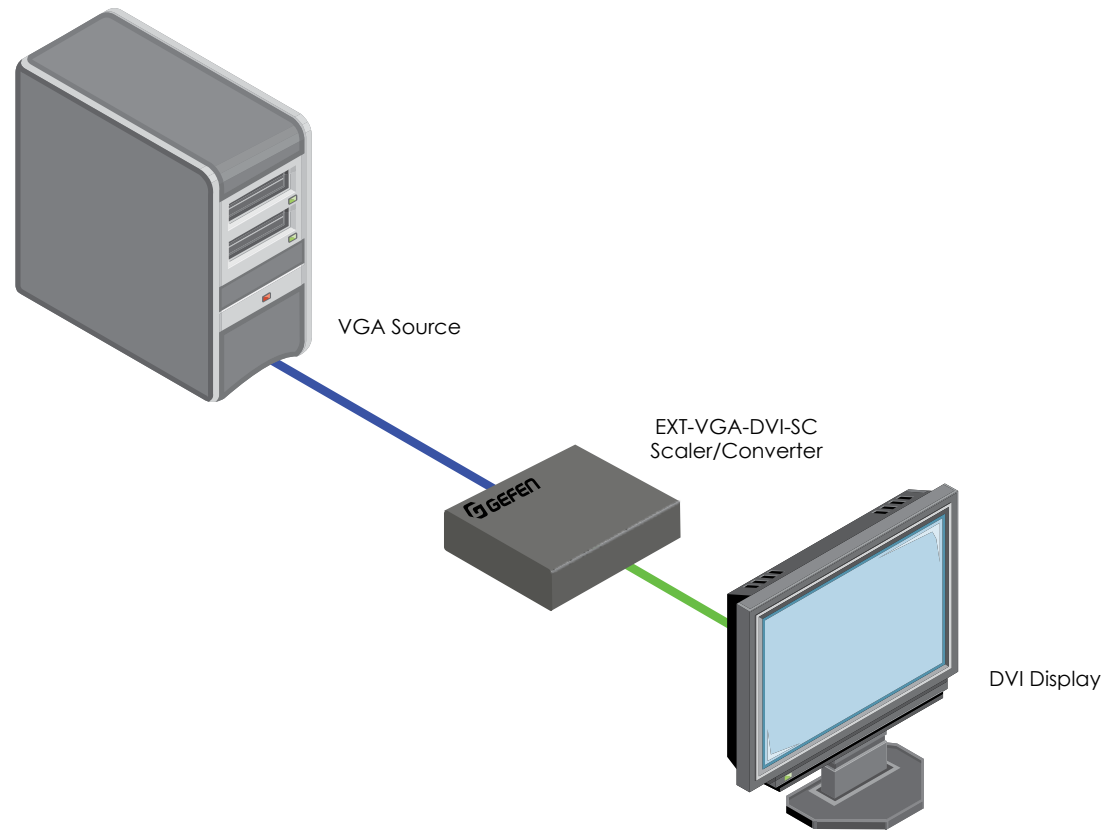

EXT-VGA-DVI-SC



VGA & Audio to HDMI Scaler/Converter



EXT-VGAA-HD-SC



Scale and convert video and audio from a VGA source for use with an HDMI Display

The Gefen EXT-VGAA-HD-SC scales and converts video from a VGA source to digital video from an HDMI output. It can also embed analog L/R audio into HDMI. Video can be scaled up to 1080p Full HD and 1920 x 1200 (WUXGA). An intuitive and comprehensive on-screen display (OSD) menu allows easy set-up and control. This product can be configured and updated using the Gefen Syner-G™ software suite. The Gefen Syner-G™ is a powerful set of software tools specifically designed to help discover, configure/customize, manage, monitor, and upgrade Gefen products. Wide power supply operating range of 6V to 24V DC offers installation flexibility for mobile use, in complex studio systems with a common power supply, and with remotely located power sources. A locking power supply connector, small footprint, and a surface-mountable enclosure facilitate easy and secure installation.

How It Works

Use the included VGA cable to connect a VGA source to the VGA input. Connect the included 3.5mm mini-stereo cable from the source to the L/R audio input. Use a Gefen locking HDMI cable to connect a display to the HDMI output. Connect the included 12V DC power supply to the unit and to an available electrical outlet. The power LED will glow in blue once the power supply is plugged in. Once the unit is connected, powered on, and displaying video, press the Menu button to bring up the On-Screen Display (OSD). The Up and Dn (down) buttons are used to navigate through the various functions of the OSD.

 This product has been specifically designed for use with the Gefen Syner-G™ Software Suite, available for download at www.gefen.com. In addition to all the configuration settings that are available from the On Screen Display, the Gefen Syner-G™ simplifies in-field firmware updates and provides the ability to configure this scaler/converter for custom input timings.

Features*

- Converts and scales VGA and L/R analog audio to HDMI
- Input resolutions up to 1920 x 1200 (WUXGA)
- Output resolutions up to 1080p60 and 1920 x 1200 (WUXGA)
- On-screen display (OSD) menu allows easy set-up and control
- Aspect Ratio Control: Full Screen, Panoramic, Letter/Pillar, Extract/Crop
- Test Pattern Generator for quick system configuration
- Embeds 2-channel analog stereo audio in HDMI signal
- Gefen Syner-G™ simplifies in-field firmware updates and advanced EDID management including custom input timings
- USB port for use with Gefen Syner-G™
- Wide power supply operating range (6V to 24V DC)
- Locking power supply connector
- Surface mountable

Specifications*

- Maximum Pixel Clock: 165 MHz
- Maximum TMDS Clock: 225 MHz
- Video Input Connector: (1) VGA HD-15, female
- Video Output Connector: (1) HDMI Type A 19-pin, female, locking
- Audio Input Connector: (1) 3.5mm mini-stereo jack
- USB Connector: (1) Mini-B
- Menu/Navigation Switches: (3) tact-type
- Power Indicator: (1) LED, blue
- Power Supply Connector: (1) 3-pin, locking
- Power Supply: 12V DC nominal (6V to 24V DC operating range)
- Power Consumption: 2.6W maximum
- Operating Temperature: +32 to +122 °F (0 to +50 °C)
- Operating Humidity: 5% to 90% RH, non-condensing
- Storage Temperature: -4 to +185 °F (-20 to +85 °C)
- Storage Humidity: 0% to 95% RH, non-condensing
- MTBF: 50000 hours
- Dimensions (excluding connectors, W x H x D): 4.9" x 1" x 3.2" (123mm x 26mm x 82mm)
- Net Unit Weight: 0.4 lbs. (0.2kg)





- VGA CABLE** 
- HDMI CABLE** 
- MINI STEREO AUDIO CABLE** 

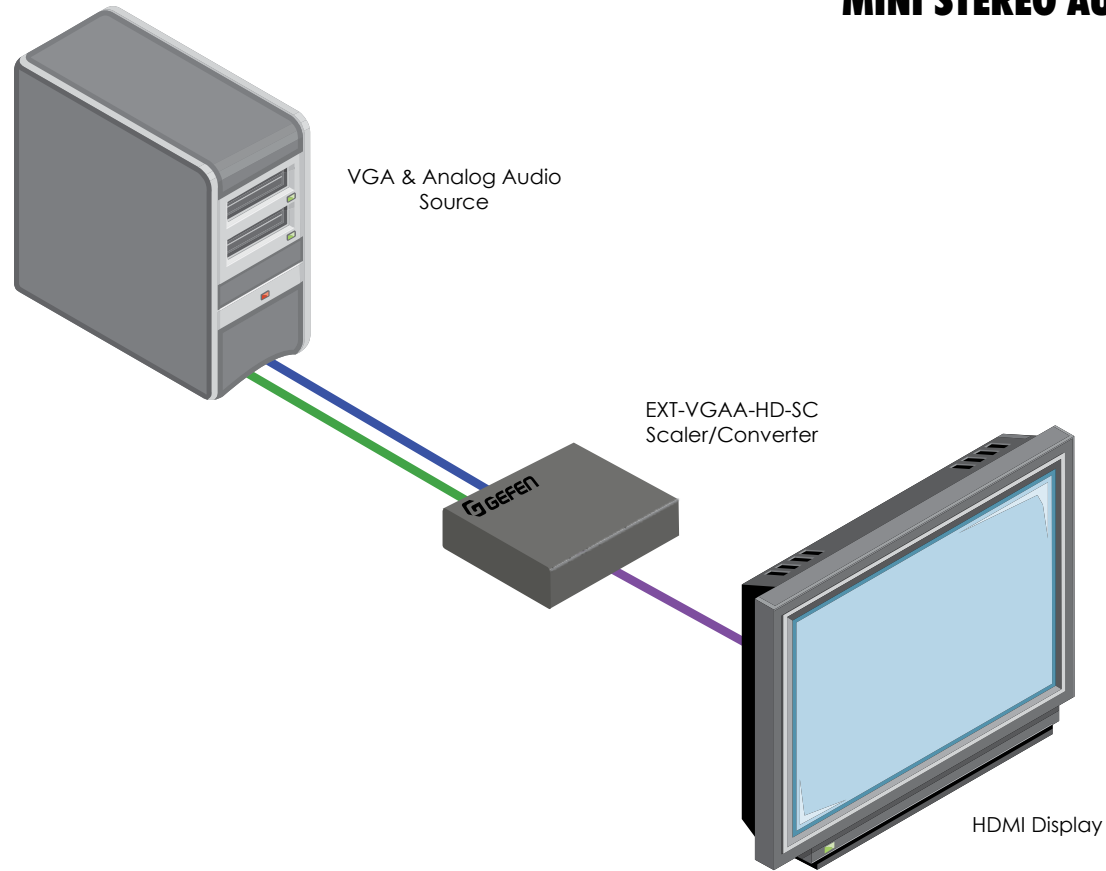

EXT-VGAA-HD-SC

Multi-Format Processor





Multi-Format Processor



Intuitive and Powerful Web Server Interface



EXT-MFP



Switch, convert, and scale today's most advanced and legacy AV formats

The Gefen EXT-MFP Multi-Format Audio/Video Processor is a compact and powerful presentation switcher with cutting edge format conversion and scaling abilities. It supports input and output resolutions up to 1080p Full HD and 1920 x 1200 (WUXGA), with HDCP. Its unique features include an intuitive and elegant web server interface, an easy-to-use On Screen Display (OSD), IP (Telnet and UDP) control, RS-232 control, IR control, independently password-protected user and administrator access, advanced EDID management, a wide variety of video inputs including Mac and PC compatible DisplayPort, independent and configurable audio and video routing, input selection via contact closure, assignable input naming, and a compact form factor that can be surface or rack mounted, or placed on a shelf. The EXT-MFP features full compatibility with the Gefen Syner-G™ software, including Discovery, Show-Me, and IP configuration. It is a complete and cost-effective solution for managing video and audio in classrooms, conference rooms, command centers, and as the backbone of any other high performance system that needs to interface with multiple sources, AV formats, and resolutions in a dynamic environment.

How It Works

If this product will be placed on a shelf, attach the included rubber feet to the bottom of the unit. If two units are to be mounted in a standard 19-inch wide rack, use the Gefen EXT-RACK-1U-GRY rack tray (available separately). Attach the EXT-MFP to the rack tray using the two machine screws provided. It can also be mounted on a surface using the L-brackets provided. The following inputs are available on the EXT-MFP: HDMI, DVI, DisplayPort, VGA, and Composite Video. Connect them to compatible AV or video sources, using high quality cables specific to each format and resolution. Connect up to two displays, projectors, or downstream equipment to the HDMI and DVI outputs. Connect up to two digital audio sources to TOSLINK® Optical and S/PDIF Coaxial inputs. Connect up to two analog audio sources to the L/R 1 and L/R 2 inputs using 3.5mm mini-stereo cables. Connect a pair of L/R RCA cables from Audio Out to the input of a 2-channel power amplifier. To select inputs via contact closure, wire the relays from an automation control device to the 6-pin Phoenix quick-disconnect plug and connect it to the Input Control port of the Multi-Format Processor. This product can be set up and operated via the front panel push buttons or the included IR remote control, in conjunction with its on screen menu system. It can also be configured and controlled through its web server interface, Telnet, UDP, or RS-232. To control the unit via IR, point the handheld remote towards the front panel of the unit. If the processor is not located within the line of sight of the handheld remote, connect a Gefen EXT-RMT-EXTIRN IR Extender to the IR Ext port and install it in a location where it can receive the IR commands. To facilitate independent IR control of multiple units installed in close proximity, the remote and the EXT-MFP can be configured to work with four distinct sets of IR codes. For IP control, connect a CAT-5 cable from your Local Area Network to the IP Control port. For RS-232 control, connect a DB-9 cable from the RS-232 port to an automation control device. Connect the included power supply to the 12V DC power supply jack and to an available electrical outlet. Press and release the Power button to toggle between On and Standby modes. When the processor is on, the Power LED will glow in blue. A red power LED indicates that the unit is in Standby. The audio/video LED indicators on the front of the processor will glow bright green when the corresponding input is selected.

Features*

- Independent and configurable audio and video routing
- Supports input and output resolutions up to 1080p Full HD & 1920 x 1200 (WUXGA)
- HDCP compliant
- HDMI, DisplayPort, DVI, VGA, and Composite Video inputs
- DisplayPort input is compatible with Mac and PC computers
- TOSLINK® optical digital, S/PDIF coaxial digital, and two analog L/R audio inputs
- Each audio source can be independently assigned to any video source
- Audio sources can be temporarily switched away from their assigned video sources
- On-screen display (OSD) menu and web server interface allow easy set-up & control
- IP control via Telnet, UDP, and web server interface
- RS-232 Serial interface for use with an automation control system
- Independent IR control of up to four units in proximity, using distinct command sets
- Password-protected user and administrative access
- Advanced EDID Management for rapid integration of sources and displays
- Assignable input naming
- System Configuration Upload/Download function
- Plug-and-Play installation with little to no set-up
- Locking power supply connector
- Rack-mountable using EXT-RACK-1U-GRY (available separately)
- Surface-mountable using the included L-brackets

Specifications*

- Maximum Pixel Clock: 165 MHz
- Maximum TMDS Clock: 225 MHz
- Video Input Connectors:
 - (1) HDMI Type A 19-pin, female, locking
 - (1) DisplayPort, 20-pin, female
 - (1) DVI-I, 29-pin, female, digital only
 - (1) VGA HD-15, female
 - (1) Composite, RCA-type, female
- Audio Input Connectors:
 - (2) 3.5mm mini-stereo jack
 - (1) TOSLINK® optical, female
 - (1) S/PDIF Coaxial, RCA-type, female
- Video Output Connectors:
 - (1) HDMI Type A 19-pin, female, locking
 - (1) DVI-I, 29-pin, female, digital only
- Audio Output Connectors: RCA x 2
- USB Connector: (1) Mini-B (factory use only)
- IR Sensor: (1) on front panel
- IR Extender Port: (1) 3.5mm mini-stereo jack
- IR Extender Type: EXT-RMT-EXTIRN
- Input Selection Contact Closure Connector: 6-pin Phoenix quick-disconnect
- IP Port: (1) RJ-45 jack
- RS-232 Port: (1) DB-9, female
- Input Select Button: (1) tact-type
- Power/Stand-by Button: (1) tact-type
- Power/Standby Indicator: (1) bi-color LED, blue/red
- Video Input Indicators: (5) LEDs, green
- Audio Input Indicators: (5) LEDs, green
- Power Supply Connector: (1) 3-pin, locking
- Power Supply: 12V DC
- Power Consumption: 8.5W maximum
- Operating Temperature: +32 to +122 °F (0 to +50 °C)
- Operating Humidity: 5% to 90% RH, non-condensing
- Storage Temperature: -4 to +185 °F (-20 to +85 °C)
- Storage Humidity: 0% to 95% RH, non-condensing
- MTBF: 50000 hours
- Dimensions (excluding buttons & connectors, W x H x D): 8.4" x 1.6" x 8.5" (213mm x 41mm x 216mm)
- Net Unit Weight: 3.2 lbs (1.5 kg)



 This product has been specifically designed for use with the Gefen Syner-G™ Software Suite, available for download at www.gefen.com. The Gefen Syner-G™ Discovery and Show-Me features simplify initial IP configuration.

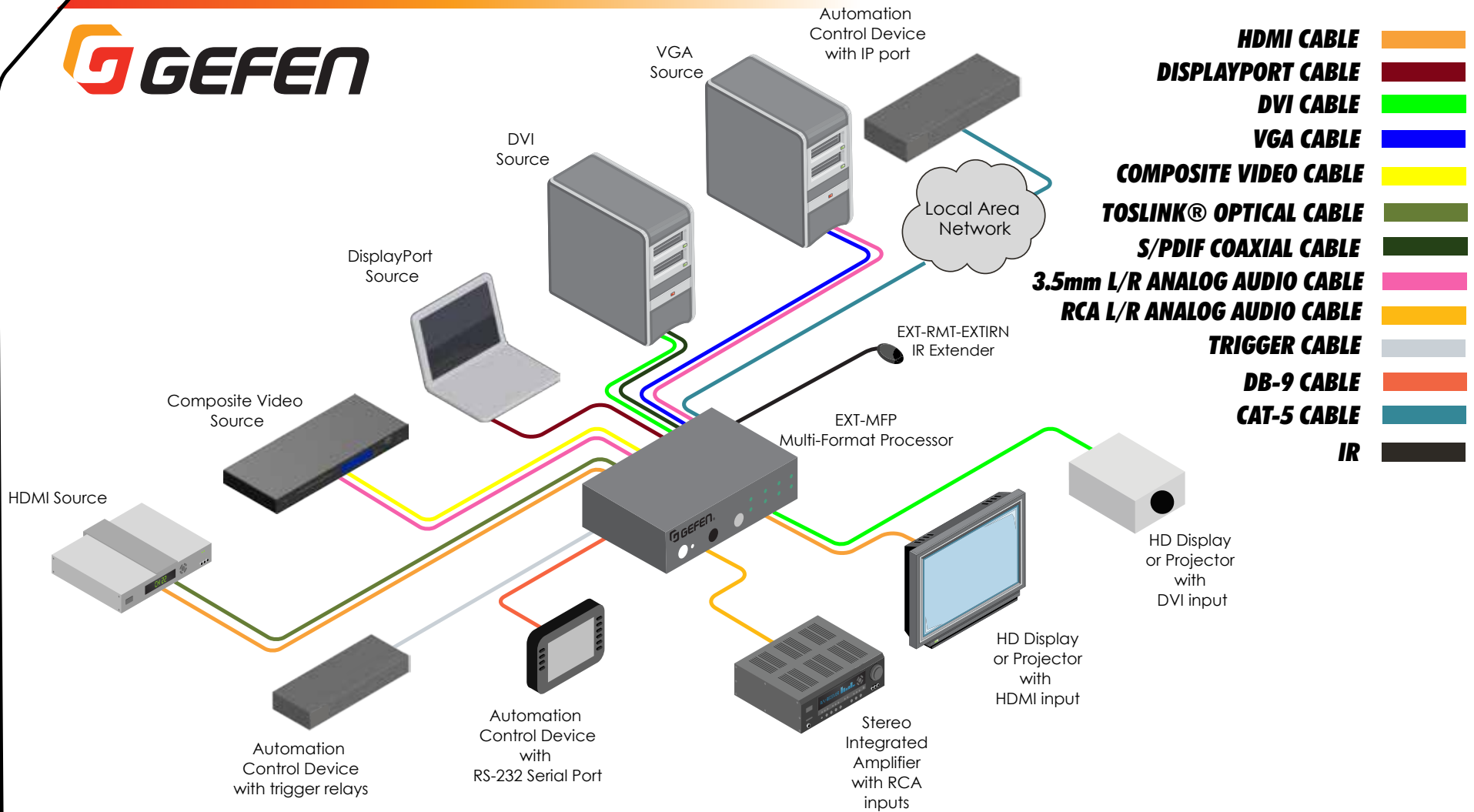

EXT-MFP

Multiview Switcher





4x1 DVI KVM Multiview Switcher



EXT-DVIK-MV-41

Interface four computers to one dual-screen workstation

The EXT-DVIK-MV-41 is the perfect solution for controlling four computers from a dual monitor workstation. The operator can observe up to 4 pictures on one screen, while a second monitor can be switched to display the picture that needs closer attention. This product is HDCP compliant, supporting input and output resolutions up to 1920 x 1200 (WUXGA) and 1080p Full HD. The two front panel USB ports and/or Bi-Directional audio (mic and headphones/speaker) can be independently routed from any of the four computers to the workstation.

Four default factory presets provide most commonly used arrangements of windows on a display, including single window output, Picture-In-Picture, Quad view, and Picture-And-Picture. The 4x1 DVI KVM Multiview Switcher is controllable via front panel, keyboard/mouse, and RS-232. An intuitive on-screen Graphical User Interface simplifies system configuration and operation. Up to 8 DVI KVM Switchers can be daisy-chained together to create an elaborate 32 computer workstation. This product is field firmware upgradable with the Gefen Syner-G™ software suite.

How It Works

This product can be placed on a shelf or mounted in a standard 19-inch rack. Connect DVI video output, USB, L/R audio output, and microphone input from up to four computers to DVI-D In, USB Host, L/R In, and Mic ports for Source 1 through 4 on the back panel of EXT-DVIK-MV-41. Connect up to two DVI displays to the Video A DVI-D and Video B DVI-D Outputs. Connect a pair of headphones or powered speakers to the L/R Out audio output. Connect a mono PC microphone to the Mic jack. Connect a keyboard and a mouse to the Workstation USB ports on the back of the unit. Two USB peripherals can be connected to the USB ports on the front of the switcher. If rack-mounting the unit, securely connect the Grounding Terminal to the system ground by 16 AWG or larger diameter copper wiring. Connect the included 12V DC power supply to the unit's 12V DC power supply jack and to an available electrical outlet. To power on the KVM switcher by flipping the Main switch to on position. The switcher can be controlled by using the front panel push-buttons, keyboard/mouse, or via RS-232. To control the switcher via RS-232, connect an automation controller to RS-232 In. To cascade the KVM Switchers together to create an expanded system, connect the RS-232 output from the first unit to the RS-232 input of the next unit until all units are daisy-chained. Up to 8 EXT-DVIK-MV-41 Switchers can be connected together to form an elaborate 32 computer system controlled by a single set of keyboard and mouse. The Power LED on the front of the switcher will glow blue when the unit is powered-on. The Video, Audio, and USB LED indicators will glow in blue when the corresponding input is selected.

Features*

- Dual Screen Workstation Set-up: Full Screen and Multiview
- 4 Multiview Modes: Full Screen, Quad-View, PIP (Picture-In-Picture), and PAP (Picture-And-Picture)
- Input and Output resolutions up to 1920 x 1200 (WUXGA) and 1080p Full HD
- HDCP 1.4 Compliant
- Controlled via front panel, keyboard/mouse, and RS-232.
- Comprehensive and easy-to-use On Screen Display.
- Supports cascading of up to 8 units to create a 32 computer system controlled from one keyboard/mouse workstation.
- Firmware update via USB port using the Gefen Syner-G™ software
- Locking power supply connector
- Rack-mountable using the included brackets

Specifications*

- Maximum Pixel Clock: 165 MHz
- Maximum TMDS Clock: 225 MHz
- Video Input Connectors: (4) DVI-I, 29-pin, female (digital only)
- Video Output Connectors: (2) DVI-I, 29-pin, female (digital only)
- USB Connectors:
 - Front Panel: (2) Type A, 5V DC at 1A maximum shared current
 - Rear Panel: (2) Type A, 5V DC at 1A maximum shared current
 - Rear Panel: (4) Type B
- Microphone Input: (1) 3.5mm mini-mono jack
- Microphone Outputs: (4) 3.5mm mini-mono jacks
- L/R Audio Inputs: (4) 3.5mm mini-stereo jacks
- L/R Audio Output: (1) 3.5mm mini-stereo jack
- RS-232 Input Port: (1) DB-9, female
- RS-232 Output Port: (1) DB-9, male
- Main Power Switch: (1) toggle, on back panel
- Chassis Ground Connection: (1) machine screw, on back panel
- Front Panel Controls: (10) tact-type, blue backlight, (6) tact-type
- Power Indicator: (1) LED, blue
- Video B Indicators: (4) LEDs, blue
- Audio Indicators: (4) LEDs, blue
- USB Indicators: (4) LEDs, blue
- Power Supply Connector: (1) 3-pin, locking
- Power Supply: 12V DC
- Power Consumption: 40W maximum
- Operating Temperature: +32 to +122 °F (0 to +50 °C)
- Operating Humidity: 5% to 90% RH, non-condensing
- Storage Temperature: -4 to +185 °F (-20 to +85 °C)
- Storage Humidity: 0% to 95% RH, non-condensing
- MTBF: 50000 hours
- Dimensions (excluding connectors, W x H x D):
 - 17.2" x 1.2" x 7.9" (437mm x 30mm x 200mm)
- Net Unit Weight: 3.7 lbs (1.6 kg)

This product has been specifically designed for use with the Gefen Syner-G™ Software Suite, available for download at www.gefen.com. The Gefen Syner-G™ interfaces with the EXT-DVIK-MV-41 via USB and simplifies in-field firmware updates.





- RS-232 CABLE** 
- USB CABLE** 
- 3.5mm MINI-STEREO CABLE** 
- MIC CABLE** 
- DVI CABLE** 

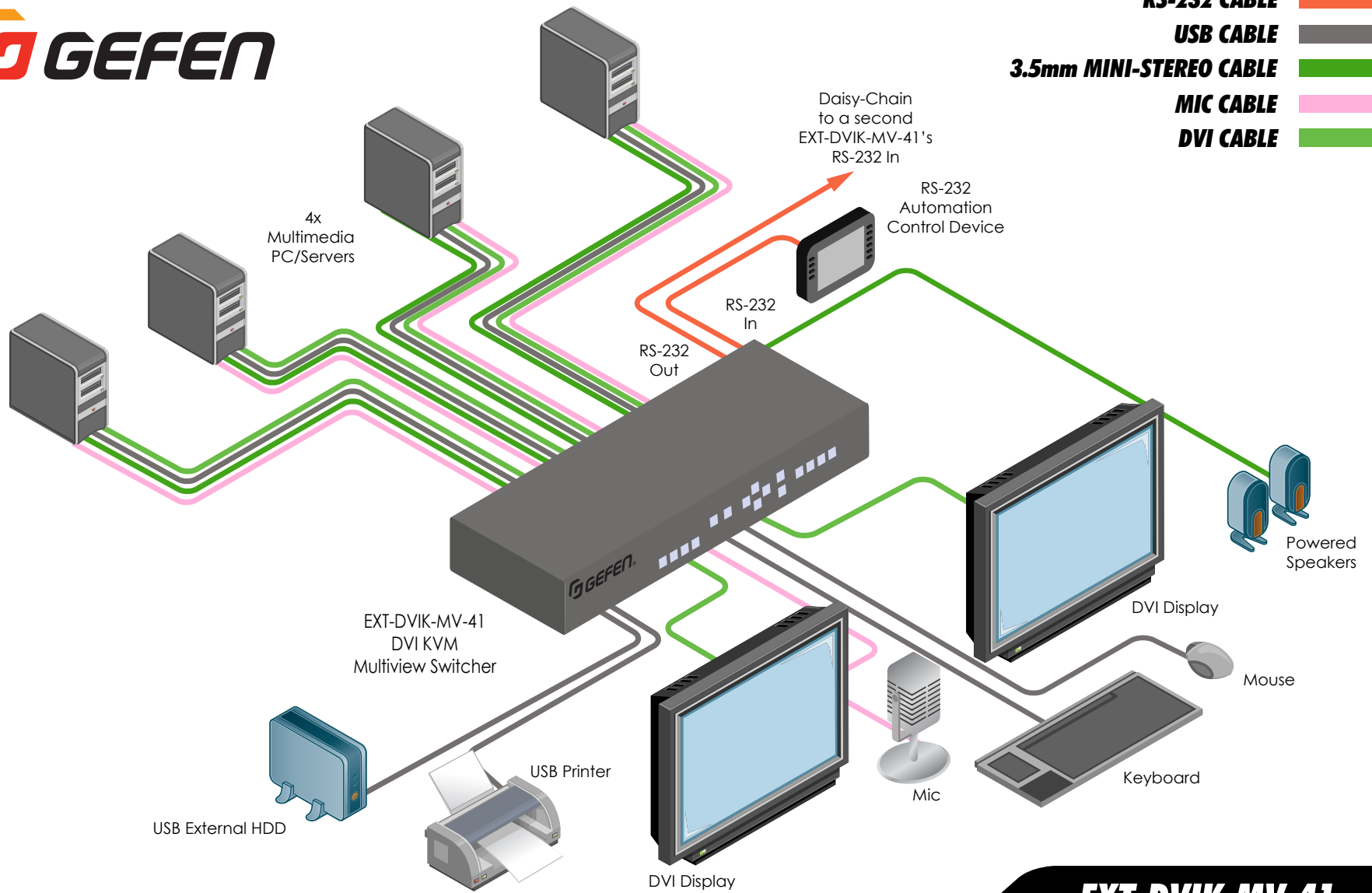

EXT-DVIK-MV-41

Digital Extenders	C1
DVI	C1
DVI and DVIKVM over CAT-5 / CAT-6.....	C1
DVI and DVIKVM over Fiber Optic.....	C1
HDMI	C1
Wireless.....	C1
HDMI over CAT-5.....	C1
HDMI over Fiber Optic.....	C1
USB and Audio Extenders over Fiber Optic and CAT-5 / CAT6.....	C2
DisplayPort over Fiber Optic and CAT-7.....	C2
DVI, HDMI and VGA over IP.....	C2
Video Wall Controllers, Multiview Switchers, Seamless Switchers, Seamless Matrix	C3
DVI and DisplayPort Switchers and Matrixes	C3
Single-Link DVI.....	C3
Dual-Link DVI.....	C3
DisplayPort.....	C3
Detectives and Boosters	C3
EDID Detectives.....	C3
Boosters.....	C3
Splitters, Converters and Scalers	C3
DVI Splitters.....	C3
HDMI Splitters.....	C3
Converters and Scalers.....	C3

Need help finding a product? Call the Gefen Sales Team at (800) 545-6900, or visit... www.gefen.com



Products on the following pages identified with a "CI" in the right column are available to Core Brands CI dealers.

Product Catalog

Cables	C4
DVI Fiber Optic Integrated Cables.....	C4
HDMI Extreme Integrated Fiber Optic Cables.....	C4
DisplayPort Extreme Fiber Optic Cables.....	C4
Dual-Link DVI Cables.....	C4
Dual-Link DVI DLX Cables.....	C4
High-Speed HDMI Cables with Ethernet and Mono•LOK™.....	C4
DVI to HDMI Cables.....	C4
VGA and other Extenders	C4
Adapters and Couplers	C4
Accessories	C4
IR Extenders, Emitters and Rack Trays.....	C4
Gefen Digital Signage	C4
Gefen ToolBox Product Line	
Splitters, Switchers and Matrixes for HDMI - 4K Ultra HD.....	C5
HD Signal Generator.....	C5
4K Ultra HD HDBaseT™ Extenders.....	C5
USB 2.0 Extenders.....	C5
Scalers	C5
Daisy Chain Extender for HDMI.....	C5
Gefen TV Product Line	
Extenders for HDMI.....	C5
Converters, Scalers and Switchers.....	C5
Audio Splitters, Switchers and Converters.....	C5
Gefen Pro Product Line	
Matrixes	C5
Extenders	C5

Digital Extenders		
DVI		
DVI and DVI-KVM over CAT-5 / CAT-6		
EXT-CAT5-1600HD	CAT5-1600HD Extends DVI with HDCP and USB 2.0 up to 200 feet away over two CAT-6a cables at resolutions reaching 1920 x 1200	
EXT-DVI-1CAT5-SR	DVI ELR Lite Extender over one CAT5 Extends any DVI source to a display up to 230 ft. away over CAT-6A cable	
EXT-DVIKVM-ELR	DVIKVM Extra Long Range Extender Extends DVI and USB to a monitor, touch screen display, or digital signage application up to 330 ft using one Cat-5 cable	
EXT-DVI-1CAT5-ELR	DVI ELR Extender over one CAT5 Extends DVI over a single CAT-5 cable up to 495 feet (150 meters)	
DVI and DVI-KVM over Fiber Optic		
EXT-DVI-1500HD	DVI•1500HD Extends DVI up to 1650 feet (500 meters) over fiber optics cables.	
EXT-DVI-FMP	DVI FM Extender PLUS Extends a DVI display up to 2000 feet using four-strand multi-mode LC fiber optic cable	
EXT-DVI-CP-FM10	DVI Fiber Optic (Pigtail Modules) Extends DVI with HDCP up to 1000 feet using single-strand fiber optic cable to a supporting display at 1920 x 1200	
EXT-DVI-FM15	DVI Fiber Optic (Donale Modules) Extends DVI up to 3300 feet to a display supporting resolutions up to 1920 x 1200 using a single-strand fiber optic cable	
EXT-DVI-FM2500	Dual Link DVI (Dongle Modules) Extends dual-link DVI up to 3300 feet to a display supporting resolutions up to 3840 x 2400 using a two-strand fiber cable	
EXT-DVI-FM500	DVI FM 500 Extender Extends hi-res DVI up to 5,000 feet over 2 strand fiber optic cables	
EXT-DVI-FM1000	DVI FM 1000 Extender Extends a DVI display up to 3,280 feet (1km) away using a single-strand SC-terminated fiber optic cable	
EXT-DVI-3600HD	DVI 3600HD Optical DVI/ USB 2.0 / RS-232/ Audio Extender Extends DVI, USB 2.0, analog audio, and RS-232 from a computer to a remote workstation up to 6,600 ft with single-link	
HDMI		
Wireless		
EXT-WHD-1080P-SR	Wireless Extender for HDMI 5 GHz SR (Short Range) Extender System Sends high definition audio and video to any HDTV screen up to 30 feet (10 meters)	CI
EXT-WHD-1080P-SR-TX	Wireless Extender for HDMI 5 GHz SR (Short Range) - Sender Package (US & Canada) Sends high definition audio and video to any HDTV screen up to 30 feet (10 meters) (Sender Only)	CI
EXT-WHD-1080P-LR	Wireless Extender for HDMI 5 GHz LR (Long Range) Extender System Sends high definition audio and video to any HDTV display up to 100 feet (30 meters)	CI
EXT-WHD-1080P-LR-TX	Wireless Extender for HDMI 5 GHz LR (Long Range) - Sender Package (US & Canada) Sends high definition audio and video to any HDTV display up to 100 feet (30 meters) (Sender Only)	CI
EXT-WHD-1080P-SR-EU	Wireless Extender for HDMI 5 GHz SR (Short Range) Extender System (EU) Sends high definition audio and video to any HDTV screen up to 30 feet (10 meters)	CI
EXT-WHD-1080P-SR-TX-EU	Wireless Extender for HDMI 5 GHz SR (Short Range) - Sender Package (EU) Sends high definition audio and video to any HDTV screen up to 30 feet (10 meters) (Sender Only)	CI
EXT-WHD-1080P-LR-EU	Wireless Extender for HDMI 5 GHz LR (Long Range) Extender System (EU) Sends high definition audio and video to any HDTV display up to 100 feet (30 meters)	CI
EXT-WHD-1080P-LR-TX-EU	Wireless Extender for HDMI 5 GHz LR (Long Range) - Sender Package (EU) Sends high definition audio and video to any HDTV display up to 100 feet (30 meters) (Sender Only)	CI
HDMI over CAT-5		
EXT-UHD-CAT5-ELRPOL	4K Ultra HD ELR-POL Extender w/ RS-232, Ethernet, and 2-way IR Extends HDMI, RS-232, Ethernet, and Bi-Directional IR over a single CAT-5 up to 495 feet (150 meters)	
EXT-HDKVM-ELR	HDKVM ELR Extender for HDMI and USB over One CAT5 Extends HDMI, KVM, and USB up to 330 feet over CAT-5	
HDMI over Fiber Optic		
EXT-HD-CP-FM10	Fiber Optic for HDMI (Pigtail Modules) Extends HDMI up to 3300 feet using a single-strand 50/125µm multimode (OM2) SC-terminated fiber optic cable	CI
EXT-HDRS2IR-4K2K-1FO	4K Ultra HD Extender over One Fiber w/ RS-232 and 2-way IR Extends HDMI, RS-232, and Bi-Directional IR over a single Fiber Optic cable up to 2 kilometers (6600 feet)	CI



Products identified with a "CI" in the right column are available to Core Brands CI dealers.

USB and Audio Extenders		
EXT-USB-400FON	USB 400 FO - Optical 4 Port USB 2.0 Hub Extends USB devices up 1640 feet (500 meters) away from the USB source	
EXT-USB2.0-LR	USB 2.0 Extender Extends USB 2.0 peripherals up to 330-feet over CAT-5 cable	CI
EXT-DIGAUD-141	Digital Audio Extender Extends your Digital S/PDIF and TOSLINK audio up to 330 ft	CI
DisplayPort over Fiber Optic and CAT-7		
EXT-DP-2CAT7	DisplayPort Extender over CAT-7 Extends DisplayPort device over 100 feet using CAT-7cables	
EXT-DP-CP-2FO	DisplayPort Extender over Fiber Optic Extends DisplayPort up to 1000 feet over two strands of fiber	
EXT-DP-CP-FM10	DisplayPort Fiber Optic (Pigtail Modules) Extends a DisplayPort up to 1000 feet using a single-strand multimode fiber optic cable with resolutions up to 2560 x 1600	
DVI, HDMI, and VGA over IP		
EXT-DVIKVM-LANRX	DVI KVM over IP - Receiver Package Includes DVI KVM over IP - Receiver Package	
EXT-DVIKVM-LAN-LRX	DVI KVM over IP w/ Local DVI Output - Receiver Unit Package DVI KVM over IP w/ Local DVI Output - Receiver Unit Package	
EXT-HD2IRS-LAN-RX	HDMI over IP with RS-232 and Bi-Directional IR - Receiver Package HDMI over IP with RS-232 and Bi-Directional IR - Receiver Package	
EXT-HDKVM-LANRX	HD KVM over IP - Receiver Package Includes HD KVM over IP - Receiver Package	
EXT-DVIKVM-LANTX	DVI KVM over IP - Sender Package Includes DVI KVM over IP - Sender Package	
EXT-DVIKVM-LAN-LTX	DVI KVM over IP w/ Local DVI Output - Sender Unit Package DVI KVM over IP w/ Local DVI Output - Sender Unit Package	
EXT-HD2IRS-LAN-TX	HDMI over IP with RS-232 and Bi-Directional IR - Sender Package HDMI over IP with RS-232 and Bi-Directional IR - Sender Package	
EXT-HDKVM-LANTX	HD KVM over IP - Sender Package Includes HD KVM over IP - Sender Package	
EXT-VGAKVM-LANRX	VGA KVM over IP - Receiver Package Includes EXT-VGAKVM-LAN Receiver Unit	
EXT-VGAKVM-LANTX	VGA KVM over IP - Sender Package Includes EXT-VGAKVM-LAN Sender Unit	
EXT-CU-LAN	Matrix Controller Manage and control Video and KVM over IP products in a virtual matrix environment	



Products identified with a "CI" in the right column are available to Core Brands CI dealers.

Video Wall Controllers, Multiview Switchers, Seamless Switchers, and Seamless Matrixes		
EXT-HD-VWC-144	HD Video Wall Controller 2x2 Wall Controller	CI
EXT-HD-SL-444	4x4 Seamless Matrix for HDMI Accepts four Hi-Def sources and routes them to any or all of four HDTV displays	
EXT-HD-MVSL-441	Multiview Seamless Switcher Accepts four Hi-Def sources and outputs them individually or as windows on a single HDTV display	CI
EXT-UHD-88	4K Ultra HD 8x8 Matrix for HDMI w/ HDCP 2.2 Routes eight 4K sources to any combination of up to eight 4K displays	CI
EXT-DVIK-MV-41	4x1 DVI KVM Multiview Switcher Interface four computers to one dual-screen workstation	
DVI and DisplayPort Switchers and Matrixes		
Single-Link DVI		
EXT-DVI-848	8x8 DVI Matrix Combine eight DVI-compliant devices with HDCP (when used in EDID pass-through mode) and eight DVI displays	
EXT-DVI-16416	16x16 DVI Crosspoint Matrix Combine sixteen cross-platform computers and sixteen DVI displays	
Dual-Link DVI		
EXT-DVI-444DL	4x4 DVI Dual Link Matrix Switches four DVI Dual Link video sources to any four DVI Dual Link displays	
EXT-DVIKVM-241DL	2x1 DVI KVM DL Switcher Switches dual-link DVI, USB 2.0 & Audio between two Computers (PC or Mac)	
EXT-DVIKVM-441DL	4x1 DVI KVM DL Switcher Switches a workstation between any 4 computers with support for dual-link or single-link DVI, USB 2.0 and audio signals	
EXT-DVIKVM-841DL	8x1 DVI KVM DL Switcher Switch between any eight computers (Mac or PC) using one Dual Link DVI Display	
EXT-DVIKVM-444DL	4x4 DVI KVM Dual Link Matrix Switches four sources w/ USB and audio to 4 dual link DVI displays	
DisplayPort		
EXT-DPKVM-241	2x1 DisplayPort KVM Switcher KVM Switching Between Two DisplayPort Sources Using One Display	
EXT-DP-144	1:4 Splitter for DisplayPort Allows a DisplayPort-equipped source to be connected to four DisplayPort displays	
Detectives and Boosters		
EDID Detectives		
EXT-HD-EDIDPN	HDMI Detective Plus Use EDID to ensure that a connected Hi-Def source sends compatible audio and video signals	CI
EXT-DVI-EDIDN	DVI Detective N Stores DVI EDID information w/Locking EDID and Program Button	
EXT-DVI-EDIDP	DVI Detective Plus Records the EDID from a display and makes it available to a source at all times	
Boosters		
EXT-HDBOOST-141	Booster for HDMI with EDID Detective Extends HDMI up to 115 feet at 4K Ultra HD resolutions	CI
EXT-DVI-141DLBP	DVI DL Booster PLUS (Dual Link) Extends a dual-link DVI source with HDCP up to 200 feet away at resolutions reaching 2560 x 1600	
EXT-HDMI1.3-141SBP	Super Booster PLUS for HDMI 1.3 Extends HDMI 1.3 up to 100 ft. and HDMI 1.2 up to 200 ft	
Splitters, Converters, and Scalers		
DVI Splitters		
EXT-DVI-142DLN	1:2 Dual Link DVI Distribution Amplifier Splits video using a dual link DVI source to two DVI dual link outputs	
EXT-DVI-144DL	1:4 DVI Dual Link Splitter Distributes a dual-link DVI source to four dual-link DVI outputs, without losing quality or resolution	
EXT-DVI-144N	1:4 DVI Splitter Connect one DVI source to four DVI displays	
EXT-DVI-148	1x8 DVI Distribution Amplifier Connect one DVI source with HDCP to up to eight DVI displays	
HDMI Splitters		
EXT-HDMI1.3-142D	1:2 Splitter for HDMI 1.3 with Digital Audio Sends a Hi-Def A/V source with HDCP to up to 2 HDTV displays at the same time without losing quality or resolution	CI
EXT-HDMI1.3-144	1:4 Splitter for HDMI 1.3 Allow an HDMI source with HDCP to be connected to four HDTV displays	CI
Converters and Scalers		
EXT-MFP	Audio/Video Multi-Format Processor Compact and powerful presentation switcher with cutting edge format conversion and scaling abilities	CI
EXT-HDVGA-3G-SC	HD & VGA to 3GSDI Scaler / Converter Scales and converts video from an HDMI or a VGA source to SDI formats	
EXT-VGAA-HD-SC	VGA & Audio to HD Scaler / Converter Scales and converts video from a VGA source to digital video from an HDMI output	CI
EXT-VGA-DVI-SC	VGA to DVI Scaler / Converter Scales and converts video from a VGA source to a DVI output	
EXT-HD-3G-C	HDMI to 3GSDI Converter Converts audio and video from HDMI to 3G-SDI and single link HD-SDI	
EXT-3G-HD-C	3GSDI to HDMI Converter Converts audio and video from SDI to HDMI	
EXT-DVI-2-VGAN	DVI to VGA Converter Converts DVI-D to VGA	
EXT-DVI-2-HDSDISSL	DVI to HD-SDI Single Link Scaler Box Converts and Scales DVI to HD-SDI/SDI	

Products identified with a "CI" in the right column are available to Core Brands CI dealers.

Cables		
DVI Fiber Optic Integrated Cable		
CAB-DVIFO-60MM	Multimode DVIFO DVI-D Fiber Optic Cable 66 ft (M-M) DVIFO DVI-D Fiber Optic Cable 66 ft (M-M)	CI
HDTV Extreme DVI Fiber Optic Integrated Cables		
CAB-HDTV-50MM	HDTV DVI-D Fiber Optic Cable 50 ft (M-M) HDTV DVI-D Fiber Optic Cable 50 ft (M-M)	CI
CAB-HDTV-150MM	HDTV DVI-D Fiber Optic Cable 166 ft (M-M) HDTV DVI-D Fiber Optic Cable 166 ft (M-M)	CI
DisplayPort Extreme Fiber Optic Cables		
CAB-DPX-100	DisplayPort Extreme Extension Cable 100 ft DisplayPort Extreme Extension Cable 100 ft	CI
CAB-DPX-150	DisplayPort Extreme Extension Cable 164ft DisplayPort Extreme Extension Cable 164 ft	CI
Dual-Link DVI Cables		
CAB-DVIC-DLN-06MM	Dual Link DVI Copper Cable 6 ft (M-M), Black DVI-D Copper Cable 6 ft (M-M)	CI
CAB-DVIC-DLBN-50MM	Dual Link DVI Copper Cable 50 ft (M-M), Black, Retail Package Dual Link DVI Copper Cable 50 ft (M-M), Black, Retail Package	CI
Dual-Link DVI DLX Cable		
CAB-DVIC-DLX-100MM	Dual Link DVI Copper Cable 100 ft (M-M) 100 ft. DVI Dual Link DLX Copper Cable	CI
High-Speed HDMI Cables with Ethernet and Mono-LOK™		
CAB-HD-LCK-01MM	High Speed HDMI Cable with Ethernet and Mono-LOK 1 ft (M-M) High Speed HDMI Cable with Ethernet and Mono-LOK 1 ft (M-M)	CI
CAB-HD-LCK-03MM	High Speed HDMI Cable with Ethernet and Mono-LOK 3 ft (M-M) High Speed HDMI Cable with Ethernet and Mono-LOK 3 ft (M-M)	CI
CAB-HD-LCK-06MM	High Speed HDMI Cable with Ethernet and Mono-LOK 6 ft (M-M) High Speed HDMI Cable with Ethernet and Mono-LOK 6 ft (M-M)	CI
CAB-HD-LCK-10MM	High Speed HDMI Cable with Ethernet and Mono-LOK 10 ft (M-M) High Speed HDMI Cable with Ethernet and Mono-LOK 10 ft (M-M)	CI
CAB-HD-LCK-15MM	High Speed HDMI Cable with Ethernet and Mono-LOK 15 ft (M-M) High Speed HD Cable with Ethernet and Mono-LOK 15 ft (M-M)	CI
DVI TO HDMI Cables		
CAB-DVI2HDMI-LCK-06MM	DVI to HDMI Locking Cable 6 ft (M-M) DVI to HDMI Locking Cable 6 ft (M-M)	CI
CAB-DVI2HDMI-LCK-10MM	DVI to HDMI Locking Cable 10 ft (M-M) DVI to HDMI cable with Lock 10 ft	CI
VGA and Other Extenders		
EXT-VGA-141SRN	VGA Extender SRN Extends 1920x1200 resolution VGA up to 150 ft via one CAT-5e	CI
EXT-VGA-141LR	VGA Extender LR Extends 1920x1200 resolution VGA up to 330 ft via one CAT-5e	CI
EXT-VGA-AUDIO-141	VGA Audio Extender Extends 1920x1200 resolution VGA and analog audio up to 150 ft via one CAT-5e	CI
EXT-VGARS232-141	VGA RS232 Extender Extends VGA and RS232 up to 330 ft via one CAT-5e	CI
EXT-RS232	RS232 extender Extends RS232 up to 1000 ft via one CAT-5e	CI
EXT-AUD-1000	Audio Extender Extends analog stereo audio and microphone up to 1000 ft	CI
Couplers		
DVI Couplers		
ADA-DVI-FFN	DVImate (Female to Female DVI coupler) DVImate (Female to Female DVI coupler)	CI
ADA-HDMI-FF	HDMI Mate Adapter w/ Mono-LOK Female to Female Adapter with Mono-Lok	CI
Accessories		
IR Extenders and Emitters		
EXT-RMT-EXTIR	RMT IR Extender Relocate your switcher up to 6 feet away from the IR Sensor	CI
EXT-RMT-EXTIRN	IR Extender Module with Carrier Frequency Extender IR sensor up to 6 feet away.	CI
Rack Trays		
EXT-RACK-1U	1U Rack Tray Rack Tray for select Gefen half-rack-width products. See website for details.	CI
EXT-RACK-1U-GRY	1U Rack Tray - Gray Finish 1U Rack Tray - Gray Finish	CI
Gefen DS - Digital Signage		
EXT-HD-DSMP	HD Digital Signage Media Player It provides an effective means to play and schedule digital signage content with both digital and analog connections	CI
EXT-HD-DSWFPN	Digital Signage Player with Wi-Fi Plus LAN-based - supports 1080p Full HD, text tickers, 2-channel L/R audio / calendars with templates, live video, RS-232	CI



Products identified with a "CI" in the right column are available to Core Brands CI dealers.

GefenToolBox® Product Line		
Splitters, Switchers, and Matrixes for HDMI - Ultra HD 4K		
GTB-HD4K2K-142C-BLK	1:2 Splitter for HDMI 4Kx2K with Cascading Capability Distributes one Ultra Hi-Def source to two Ultra HD displays simultaneously	CI
GTB-HD4K2K-144C-BLK	1:4 Splitter for HDMI 4Kx2K with Cascading Capability Distributes one Ultra Hi-Def source to four Ultra HD displays simultaneously	CI
GTB-HD4K2K-148C-BLK	1:8 Splitter for HDMI 4Kx2K with Cascading Capability Distributes one High-Def source to eight Ultra HD displays	CI
GTB-HD4K2K-441-BLK	4x1 Switcher for HDMI 4K x 2K Switch four HD sources to one display	CI
GTB-HD4K2K-442-BLK	4x2 Matrix for HDMI 4Kx2K Route four HD sources to two displays	CI
GTB-HD4K2K-444-BLK	4x4 Matrix for HDMI 4Kx2K Route four HD sources to four displays	CI
GTB-HD4K2K-642-BLK	6x2 Matrix for HDMI 4Kx2K Route six HD sources to two displays	CI
GTB-HD4K2K-848-BLK	4K Ultra HD 8x8 Matrix for HDMI Routes eight 4K Ultra HD sources to eight displays	CI
HD Signal Generator		
GTB-HD-SIGGEN	HD Pattern Signal Generator Evaluate, Calibrate, and Test Digital Video Equipment	CI
4K Ultra HD HDBase™ Extenders		
GTB-UHD2IRS-ELRPOL-BLK	4K Ultra HD ELR-POL Extender w/ RS-232 and 2-way IR Extends HDMI, RS-232, and Bi-Directional IR over a single CAT-5 cable up to 495 feet (150 meters)	CI
GTB-HDBT-POL-BLK	Extender for HDMI with POL Extends HDMI up to 230 ft (70 m) over one CAT-5e cable up to 1080p Full HD	CI
USB 2.0 Extender		
GTB-USB2.0-4LR-BLK	USB 2.0 LR 4-Port Extender (Black) Extends a USB source up to 330 feet using a single CAT-5e cable	CI
Scaler		
GTB-HD-1080PS-BLK	High Definition 1080p Scaler - Black Scale one HDMI input with HDCP to one HDMI output with up to 1080p Full HD and Deep Color	CI
Daisy Chain Extender for HDMI		
GTB-HD-DCR-BLK	Daisy Chain HD System - Receiver Unit Distribute video to multiple displays in series using Video Over IP techniques	
GTB-HD-DCRP-BLK	Daisy Chain HD System - Splitter Unit Distribute video to multiple displays in series using Video Over IP techniques	
GTB-HD-DCS-BLK	Daisy Chain HD System - Sender Unit Distribute video to multiple displays in series using Video Over IP techniques	
GefenTV® Product Line		
Extenders for HDMI		
Wireless		
GTV-WHD-60G	Wireless for HDMI 60 GHz Extender System Sends high definition audio and video to any HDTV display up to 33 feet (10 meters)	CI
Converters, Scalers and Switchers		
GTV-DVIDL-2-MDP	Dual Link DVI to Mini DP Converter View any PC or Mac with audio support on a display using mini DisplayPort	
GTV-HDMI-2-COMPSVIDSN	HDMI to Composite / S-Video Scaler Transforms HDMI video into Composite or S-Video	CI
GTV-COMPSVID-2-HDMIS	Composite to HDMI Scaler Transforms composite or S-Video into scaled HDMI video	CI
GTV-HDMI1.3-441N	4x1 Switcher for HDMI with RS232 Shares a single HDTV display with up to 4 HDMI video sources with HDCP and RS232 support	CI
Audio Splitters, Switchers, and Converters		
GTV-DIGAUD-2-AAUD	Digital Audio to Analog Adapter Converts digital audio to L/R analog audio	CI
GTV-AAUD-2-DIGAUD	Analog to Digital Audio Adapter Takes analog audio and converts it to digital via TOSLINK / SPDIF	CI
GTV-DD-2-AA	Digital Audio Decoder Converts digital audio to analog audio with support for Dolby to create surround sound audio	CI
GTV-DIGAUDT-141	Digital Audio Translator Converts coaxial and optical digital audio formats	CI
GTV-HDMI-2-HDMIAUD	HDMI to HDMI Plus Audio Converter Converts Hi-Def source using HDMI with HDCP and outputs to an HDTV display with up to 8 channels of LPCM audio	CI
GefenPRO® Product Line		
Matrixes		
GEF-DVIKVM-848DL-PB	8x8 DVI KVM Dual Link Matrix w/ Push Button Control Route DVI, USB, and Audio from eight computers to eight Hi-Def workstations	
GEF-HDFST-MOD-16416-HD	16 x 16 Modular Matrix for HDMI w/ HDCP - HDMI In/Out 16x16 Modular Matrix For HDMI w/ HDCP - HDMI In/Out	
GEF-HDFST-MOD-16416-HDEL R	16 x 16 Modular Matrix for HDMI w/ HDCP - HDMI In/ELR Out 16x16 Modular Matrix for HDMI w/ HDCP - HDMI In/ELR Out	
GEF-HDFST-MOD-32432-HD	32 x 32 Modular Matrix for HDMI w/ HDCP - HDMI In/Out 32x32 Modular Matrix for HDMI w/ HDCP - HDMI In/HDMI Out	
GEF-HDFST-MOD-32432-HDEL R	32 x 32 Modular Matrix for HDMI w/ HDCP - HDMI In/ELR Out 32x32 Modular Matrix for HDMI w/ HDCP - HDMI In/ELR Out	
GEF-DVI-16416-PB	16x16 DVI Matrix with Front Panel Push Button Control Routes 16 DVI Sources with 16 Monitors	
Extenders		
GEF-DVI-FM1500	DVI FM1500 Optical DVI Extender with Recordable EDID Extends a DVI source up to 3280 feet (1000 meters) using single-strand SC-terminated fiber optic cable	
GEF-DVI-FM2000	DVI FM 2000 Extender (Dual Link) Extends a DVI source with HDCP to a single or dual-link display up 1000 feet away at resolutions reaching 3840 x 2400	

Products identified with a "CI" in the right column are available to Core Brands CI dealers.





gefen.com