



COMMERCIAL AUDIO PUBLIC ADDRESS

COMPONENTS AND SYSTEMS

sound culture



ENG 2015

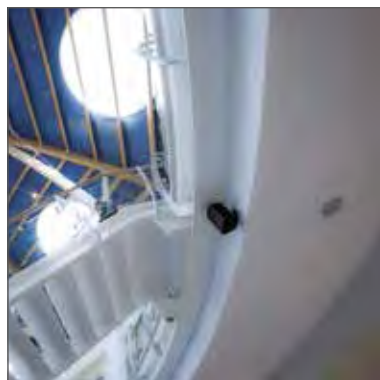



Founded in 1949, RCF built its history of sound amplification from basic solutions for small spaces to vast and complex digital systems for theatres, shopping malls, airports, railway stations, underground metro's, exhibition centres, schools, hospitals, sports arenas, stadia, hotels. Our Product's design and manufacturing are held in the Reggio Emilia headquarters where more than 240 people are employed ensuring the high quality of RCF's products and systems.



Today RCF produces a wide and diverse range of products to satisfy any sound and musical amplification need. This can range from a single product to complete integrated solution. In doing so, the company can cover everything from a small project to very large and complex system. RCF controls every step of the production process, from the design to the construction and marketing of its products. Owning its own transducers technology gives RCF an enormous advantage in the development of complete speaker systems, achieving the perfect match between transducers and electronics, now more and more focused on digital technology.





RCF has always been committed in providing complete support to its customers helping them to choose the most suitable solutions for their projects, instruct on how to install the products in the correct way and achieve the best possible performances.

This support activity **is crucial to RCF's continual success** and we keep investing in this department by expanding our engineering team of product specialists as well as the use of the latest equipments and software technologies.

The direct involvement in groups and more complex projects around the world is continually raising the know-how, experience and reputation of our team of specialists that is considered one of the best **Engineering Support Group** in our industry.



A system design must always be carried out considering the acoustics of the environment, the architectural and installation constraints, the maintenance costs and, on top of everything, the user's requirements. **The extensive and complete range of RCF products enables the Engineering Support Group to submit multiple design solutions** optimized and tailored according to costs' and performances' requirements.

ESG engineers are also involved in educational and training activities where they can exchange information and opinion with consultants and contractors participating to the RCF Audio Academy program, an extensive range of courses and workshops organized worldwide on several subjects by RCF engineers.

Engineering Support Group is able to produce:

- **Design proposal** based on supplied venue details, including environment acoustic simulation, products list, bloc diagram, speaker coverage mapping.
- **Design validation** based on design submitted by the client providing guidance on the proper selection and placement of RCF products.
- **Design of alternative solutions**, based on existing specs, providing advice and improved system configurations based upon RCF products.
- **Acoustical consultancy** for the definition of projects specifications in cooperation with architects' and contractors' offices.
- **On site** system start-up and commissioning. Furthermore RCF provides on request rack already wired completed with connection diagrams and operation manuals.
- **Educational and training activities**, included in the RCF Audio Academy world-wide program, or tailor made for the client's requirements.

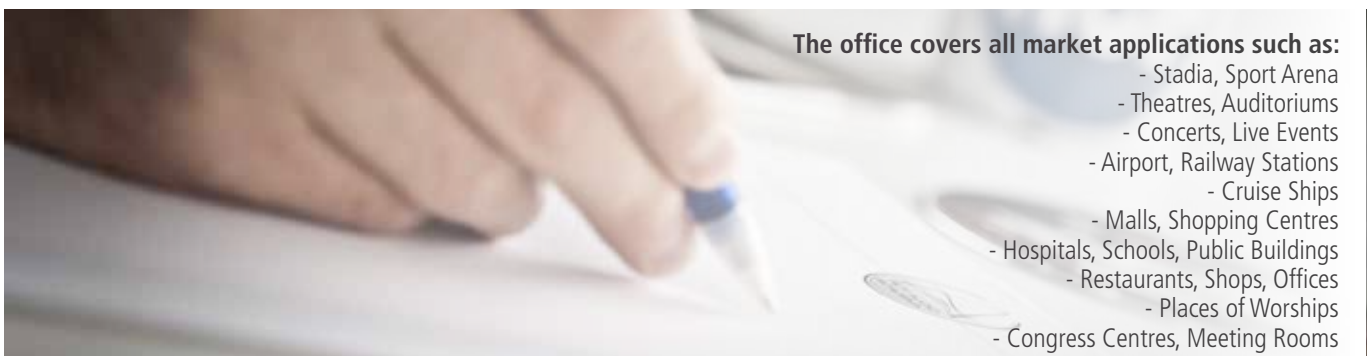

The office covers all market applications such as:

- Stadia, Sport Arena
- Theatres, Auditoriums
- Concerts, Live Events
- Airport, Railway Stations
- Cruise Ships
- Malls, Shopping Centres
- Hospitals, Schools, Public Buildings
- Restaurants, Shops, Offices
- Places of Worships
- Congress Centres, Meeting Rooms

INDEX



MULTI-ZONE SYSTEMS

Paging and background music to different zones.

6



CONFERENCE SYSTEMS

Flexible, easy to use and install. Suitable for any small hall or council chambers.

10



MICROPHONES AND WIRELESS MICROPHONES

Optimised in the voice frequency range to guarantee maximum speech clarity.

12



AUDIO SOURCES

CD players, Radio receivers, message players for every hi-fidelity listening need.

24



AMPLIFIERS AND PREAMPLIFIERS

For constant voltage systems or professional audio applications.

26



FLUSH MOUNTED AND WALL SPEAKERS

38



SOUND PROJECTORS, MONITORS AND COLUMN SPEAKERS

48



HORN SPEAKERS

60



VOLUME ATTENUATORS AND AUDIO TRANSFORMERS

To adjust the audio system according to specific needs.

64



MOBILE AMPLIFICATION

67



RACK COMPONENTS

For the optimum management of the system configurations.

68

MULTI-ZONE SYSTEMS

Paging and background music to different zones.



MODEL	MS 520	ZM 2000
MAX NUMBER OF ZONES	5 (expandable to 10)	6 (expandable to 54)
MAX. NUMBER OF PAGING MICROPHONES	1	6
AUDIO CHANNELS	5 to LINE level	2
PAGING MIC. PROGRAMMING	-	YES (chime)
SYSTEM SETUP	YES	YES
SYSTEM SETUP DISPLAY	LCD	LCD
PAGING MICROPHONE CABLES	To be chosen according to the used paging microphone and the number of paged zones	RJ45
LOUDSPEAKER CABLES	Twisted Pair	Twisted Pair
REMOTE CONTROLS	YES	YES
MUSIC ON/OFF ON EACH ZONE	YES	YES
DIRECT CURRENT POWER SUPPLY	-	YES

MS 520

p/n 121.35.043

RCF *Ambiente*

AMPLIFIER / CONTROL UNIT



- MS 520 contains all functions required by a system to send different musical programmes in homes and commercial premises
- Three different musical programmes and one for paging can be sent to five mono zones or, alternatively, 3 mono zones and one stereo zone
- It is also possible link two RCF AMBIENTE and share the music sources in order to extend the number of zones to ten
- Its backlit display and function keys make it possible to access all menus to configure and adjust the system: volume, tone, loudness, output settings, 'VOX'
- The third music source input can have priority (when enabled) over the other two music sources
- Power outlet controlled by the system to switch a connected sound sources on/off
- Black label provided for front panel

- Five amplified 20 W / 4 ohm outputs, each also available as full-range or low-pass signal at line level on RCA connectors to drive external power amplifiers (when areas to be covered are particularly large)
- A direct auxiliary input is available for each of the five zones to connect sources such as CD players, wireless microphones or mixers to be used exclusively for one zone/room
- The universal MIC-LINE input can be used for paging, with the possibility to have a tone that precedes the announcement
- The VOX function can be matched to a zone group to work without pressing keys or closing contacts (e.g. from a suitable private telephone exchange)
- For each zone, an RJ 45 connector allows the connection of remote controls (max. 3 per zone) via CAT5 cable for volume control, musical programme selection or direct input activation installable in any electrical mounting box by using the original local country supports and cover-plates

REAR VIEW

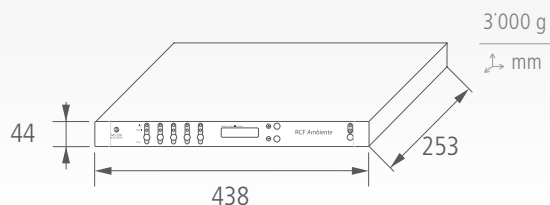

SPECIFICATIONS

SPECIFICATIONS	MS 520
OUTPUT POWER	5 x 20 W RMS
FREQUENCY RESPONSE	20 ÷ 18000 Hz (± 3 dB)
T.H.D.	< 0.5% @ 1 kHz
MIN. OUTPUT LOAD (PER ZONE)	4 Ω
TONE CONTROLS	LOW: 100 Hz ± 8 dB; HIGH: 12.5 kHz ± 8 dB
SIGNAL / NOISE RATIO	> 60 dB (PAGING IN); > 78 dB (MUSIC SOURCE IN, DIRECT IN)
INPUT SENSITIVITY	(MIC) - 58 dBu ÷ - 41 dBu (1 ÷ 7 mV); (LINE) - 43 dBu ÷ -27 dBu (5.5 ÷ 35 mV); (MUSIC, DIRECT) - 16 dBu (120 mV)
PHANTOM POWER SUPPLY (PAGING INPUT)	16 V dc
POWER SUPPLY	100 ÷ 240 V ac (50 - 60 Hz)
INPUT CONNECTORS	11 x RCA (LINE), RJ 45 FOR REMOTE CONTROLS
OUTPUT CONNECTORS	7 x RCA, SCREW TERMINALS FOR LOUDSPEAKERS

RC 62

REMOTE CONTROL FOR RCF MS 520

- RC 62-W white p/n 133.60.039
- RC 62-G gray p/n 133.60.040
- RC 62-S silver p/n 133.60.041



Designed to be simply inserted into any 503 flush / wall mounted box using original standard supports and cover-plates that can be found on the market.

It allows to select programmes and adjust the volume in the respective zone. It can turn the MS 520 in stand-by mode as well. It can be linked to a MS 520 by using CAT5 cables and RJ 45 plugs.

Available in white (W), grey (G) and silver (S)

* The picture above shows a possible installation of the RC 62 remote control (box, front plate, blank keys are not included).

ZM 2124

240W 6 ZONES POWERED
MASTER UNIT

p/n 121.35.085

16'100 g
mm

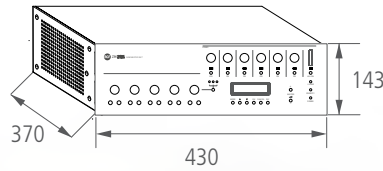

- Dual-bus system architecture
- System Paging consoles input for up to 6 selective devices daisy-chained, aux input and overall emergency input on precedence primary bus
- 4 inputs of which 2 microphone and 2 universal, 3 selectable aux inputs with individual volume and tone controls with configurable priority on secondary bus
- 240W constant voltage power amplifier with VU-meter for output signal level and overload indication.
- Auxiliary external amplifier input and output terminals to manage primary and secondary buses independently
- Volume attenuators and switches with indicators to send or not the secondary bus program (i.e. music) on each of the 6 speaker line outputs
- Link to connect up to eight ZE 2200 6six-zone expansion units so to built-up paging systems in excess of 50 zones.
- Dedicated wall mounting system remote control allows you to remote the main commands available on the master unit
- Priority indicator to show when any system priority circuit has been triggered
- Selectable chime generator is available on announcements
- GPI and GPO logic ports are available for interface purposes with third parties systems and for monitoring feedback

ZM 2100

240W 6 ZONES PRE-AMPLIFIED
MASTER UNIT

p/n 171.70.166

8'200 g
mm

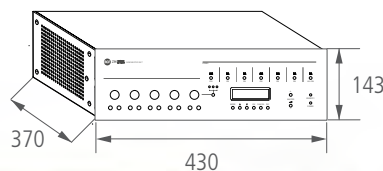

- Dual-bus system architecture
- System Paging consoles input for up to 6 selective devices daisy-chained, aux input and overall emergency input on precedence primary bus
- 4 inputs of which 2 microphone and 2 universal, 3 selectable aux inputs with individual volume and tone controls with configurable priority on secondary bus
- Interconnection terminals for power amplifiers to manage primary and secondary buses independently, using 100V single or dual amplifier configuration or 0dB multi-amplifier configuration according to system requirements
- Switches with indicators to send or not the secondary bus program (i.e. music) on each of the 6 output zones
- Link to connect up to eight ZE 2200 6six-zone expansion units so to built-up paging systems in excess of 50 zones.
- Priority indicator to show when any system priority circuit has been triggered
- Selectable chime generator is available on announcements
- GPI and GPO logic ports are available for interface purposes with third parties systems and for monitoring feedback.
- Dedicated wall mounting system remote control allows you to remote the main commands available on the master unit
- RS 232 port for FW upgrade and communication/interface purposes
- Power supply AC or DC24V, 3U 19" rack mounting

SPECIFICATIONS

	ZM 2124	ZM 2100
INTERNAL AMPLIFIER MAX. OUTPUT POWER	240 W	-
INTERNAL AMPLIFIER OUTPUT VOLTAGE	100 – 70 V (direct), 100 V (6 zones)	-
FREQUENCY RESPONSE (+1 / -3 dB)	MIC: 60 Hz ÷ 15 kHz ; AUX: 50 Hz ÷ 20 kHz	
DISTORTION	< 1%	
INPUT SENSITIVITY MIC/LINE/AUX	1,5 mV (- 54 dBu) / 200 mV (- 12 dBu) / 200 mV (- 12 dBu)	
NOISE/SIGNAL RATIO INPUT MIC/LINE/AUX	> 60 dB / > 70 dB / > 75 dB	
INPUT IMPEDANCE MIC/LINE/AUX	600 Ω (balanced) / 600 Ω (balanced) / 10 kΩ (unbalanced)	
INPUTS	4 input mic. + 3 aux su RCA + 2 paging	
OUTPUTS	6 (power)	6 a 100 V / 0 dB depending on the configuration
EMERGENCY INPUT SENSITIVITY	100 mV (unbalanced audio signal), 100 V line	
SIGNAL/NOISE RATIO EMERGENCY INPUT	> 70 dB	
EMERGENCY INPUT IMPEDANCE	600 Ω (balanced audio signal, input 100 mV)	
POWER SUPPLY	115 V / 230 V ac, 24 V dc	
MAX POWER CONSUMPTION	720 W	100 W

ZE 2200

6 ZONES EXPANSION UNIT

p/n 171.70.167

3400 g

↕ mm

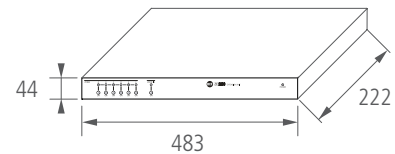

- Direct link to ZM 2100 or ZM 2124 to expand the number of the system output zones till 54 by linking up to 8 devices in daisy-chain wiring topology
- 6 zone management based on ZM 2000 dual-bus system architecture: primary and secondary buses. Interconnection terminals for power amplifiers to manage primary and secondary buses independently
- GPI and GPO logic ports are available for interface purposes with third parties systems and for monitoring feedback.

SPECIFICATIONS

FREQUENCY RESPONSE (+1 / -3 dB)	50 Hz ÷ 20 kHz
AUX INPUT SENSITIVITY	1 V (+ 2 dBu)
SIGNAL/NOISE RATIO INPUT AUX	> 75 dB
IMPEDANCE INPUT AUX	10 kΩ (unbalanced)
INPUTS / OUTPUTS	6 a 100 V / 0 dB depending on the configuration
POWER SUPPLY	115 V / 230 V ac (50-60 Hz), 24 V
MAX CONSUMO DI POTENZA	15 W

ZE 2200

BM 2006

PAGING MICROPHONE

p/n 143.22.021



- 6 zone buttons for selective announcements
- 1 general call button.
- Up to 6 consoles can be linked to the main unit.

BE 2012

EXTENSION MODULE

p/n 143.22.022



- 12 buttons for selective announcements on the zones.
- Extensione for BM 2006 console
- Up to 4 extensions can be linked to BM2006

RC 2946

WALL MOUNT REMOTE CONTROL

p/n 133.60.237



- Wall mount remote control for the main units.
- It controls the unit zones, source and volume (shown on the display).
- Input for an external audio source.
- Balanced mic input for announcements.
- Inputs are mixable and adjustable.

SPECIFICATIONS

POWER HANDLING	BM 2600 24 V c.c.	BE 2012 24 V c.c. (with BM 2006)
MAX ABSORBED POWER	50 mA (BM 2006 only) 130 mA (with 1 BE 2012) 210 mA (with 2 BE 2012) 290 mA (with 3 BE 2012) 370 mA (with 4 BE 2012)	80 mA (with one single BE 2012)
MAX. OUTPUT LEVEL	1 V (RMS)	-
FREQUENCY RESPONSE	100 Hz ÷ 15 kHz	-
VOICE FILTER	high pass, cutoff frequency: 315 Hz 6 dB / octave	-
DIMENSIONS (L, H, P)	108 mm, 55 mm, 240 mm (BM 2006 only)	108 mm, 55 mm, 240 mm
WEIGHT	1 kg (solo BM 2006)	0,7 kg

FORUM 3000

Flexible, easy to use and install.
Suitable for any small hall and council chambers.



MMU 3100

MASTER UNIT

| p/n 171.80.042

5'200 g
↕ mm

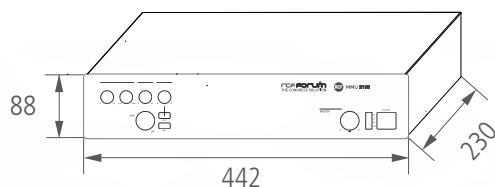

- Input to connect up to 80 microphone sets with volume and voice EQ controls
- Additional universal input on both XLR and removable screw terminals for lectern microphone or interview microphone or other sources with volume and voice EQ controls. Input can be set as mixed or with precedence on the system microphone consoles, controlled by an external command or voice activated; Phantom power available.
- Input and outputs connections to an external recorder/player device, PLAY / REC selector switches with LED indicators. Volume control and tone EQ on PLAY-OUT
- Teleconference dedicated input and output
- Sound reinforcement and recording system output
- Built-in power amplifier to feed the consoles speakers with volume selector
- Built-in 80W power amplifier output with volume control for additional constant voltage sound reinforcement speakers
- Connection to link two MMU 3100 units to increase microphone sets to 160 units
- 2U 19" standard rack, mounting ears provided

SPECIFICATIONS

POWER SUPPLY	MMU 3100 115-230V / 50-60 Hz
MAXIMUM POWER CONSUMPTION	240 W
DIMENSIONS (W X H X D)	442 x 88 x 230 mm
WEIGHT	4 Kg
DESK INPUT	
SENSITIVITY	-7 dBu (max. + 13 dBu)
IMPEDANCE	1 Ω
INGRESSO PLAY	
SENSITIVITY	-7 dBu (max. + 13 dBu)
IMPEDANCE	20 Ω
MIXER OUT	
MAXIMUM POWER LEVEL	+21 dBu
IMPEDANCE	100 Ω
RECORDING OUTPUT	
FREQUENCY RESPONSE (-3 dB)	35 Hz ÷ 20 kHz
S/N RATIO	≥ 85 dBA

MMS 3405P

CHAIRMAN MICROPHONE SET

p/n 143.22.019



1'000 g

↕ mm

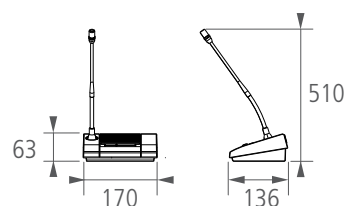

- Chairman Microphone Set MMS 3405P
- PRO-quality cardioid microphone with LED ring mounted on 46cm gooseneck
- Push-to-lock switch for microphone activation in mixed mode, with LED indicator
- Push-to-talk switch for microphone activation in priority mode, with LED indicator
- Hi quality transducer for sound reinforcement purpose, automatically disabled when microphone is active
- RJ 45 terminal for the connection to MMU 3100 master unit through CAT5 FTP cable
- Two RJ 45 connectors to daisy-chain delegate consoles branches through CAT5 FTP cable
- Robust shielded enclosure suitable for desktop or semi-flush mounting

SPECIFICATIONS

MICROPHONE CAPSULE	MMS 3405P
TYPE	ELECTRET
SENSITIVITY	HYPERCARDIOID
FREQUENCY RESPONSE	0.56 mV / Pa
SPEAKER POWER	70 Hz ÷ 18 kHz
CONNECTORS	1 W
WEIGHT	RJ 45
	1 kg

MMS 3404D

DELEGATE MICROPHONE SET

p/n 143.22.020



1'000 g

↕ mm

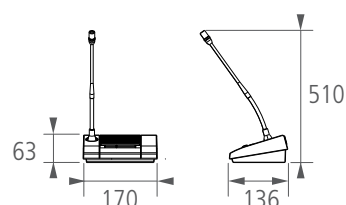

- Delegate Microphone Set MMS 3404D
- PRO-quality cardioid microphone with LED ring mounted on 46cm gooseneck
- Push-to-lock switch for microphone activation in mixed mode, with LED indicator
- Hi quality transducer for sound reinforcement purpose, automatically disabled when microphone is active
- RJ 45 terminals for daisy-chain link to MMS 3405P chairman console through CAT5 FTP cable
- Robust shielded enclosure suitable for desktop or semi-flush mounting

SPECIFICATIONS

MICROPHONE CAPSULE	MMS 3404D
TYPE	ELECTRET
SENSITIVITY	HYPERCARDIOID
FREQUENCY RESPONSE	0.56 mV / Pa
SPEAKER POWER	70 Hz ÷ 18 kHz
CONNECTORS	1 W
WEIGHT	RJ 45
	1 kg

MICROPHONES AND WIRELESS MICROPHONES

Optimised in the voice frequency range to guarantee maximum speech clarity.



MODEL	MD 7600	MD 7800	MD 6000X
TYPE	Dynamic	Dynamic	Dynamic
POLAR PATTERN	Supercardioid	Supercardioid	Cardioid
FREQUENCY RESPONSE	60 ÷ 16000 Hz	60 ÷ 20000 Hz	300 ÷ 3000 Hz
SENSITIVITY (0 dB=1V/ μ bar, 1kHz)	- 75 dB	- 70 dB	- 70 dB
PHANTOM PWR. SUPPLY	-	-	-
CONNECTOR	3 pole XLR (M)	3 pole XLR (M)	3 pole XLR (M)
ON/OFF SWITCH	Yes	Yes	Yes
USE	Speech, singing	Speech, singing	Speech, emergency



MODEL	MC 4064	MC 5030	MC 5054
TYPE	Electret	Electret	Electret
POLAR PATTERN	Cardioid	Cardioid	Cardioid
FREQUENCY RESPONSE	50 ÷ 18.000 Hz	80 ÷ 14000 Hz	50 ÷ 14.000 Hz
SENSITIVITY (0 dB=1V/ μ bar, 1kHz)	- 58 dB	- 75 dB	- 68 dB
PHANTOM PWR. SUPPLY	12 ÷ 52 V	12 ÷ 48 V	9 ÷ 52 V
CONNECTOR	XLR 3 (M)	3 pole XLR (M)	XLR 3 (M)
ON/OFF SWITCH	Yes	Yes	No
USE	Speech, conference	Speech, announcements	Speech, announcements



MODEL	BM 3001	BM 3003	BM 3022	BM 3014
TYPE	Electret	Electret	Electret	Dynamic
POLARN PATTERN	Cardioid	Cardioid	Cardioid	Cardioid
FREQUENCY RESPONSE	50 ÷ 18000 Hz	50 ÷ 18000 Hz	100 ÷ 12000 Hz	100 ÷ 12000 Hz
SENSITIVITY (0 dB=1V/ μ bar, 1kHz)	- 65 dB	- 65 dB	- 82 dB	- 80 dB
POWER SUPPLY	18 ÷ 48 V PHANTOM	115 - 230 V ac / 24 V dc	115 - 230 V ac / 24 V dc	-
CONNECTORS	RJ 45	RJ 45	RJ 45	3 pole XLR (M)
ON/OFF SWITCH	Yes	Yes	Yes	Yes
USE	Announcements	Announcements	Announcements	Announcements



MODEL	MT 3100	MT 3200
TYPE	Electret	Electret
POLAR PATTERN	Omnidirectional	Semicardioid
FREQUENCY RESPONSE	50 ÷ 18000 Hz	50 ÷ 18000 Hz
SENSITIVITY (0 dB=1V/ μ bar, 1kHz)	- 58 dB	- 58 dB
PHANTOM PWR. SUPPLY	12 ÷ 52 V	12 ÷ 52 V
CONNECTOR	3 pole XLR (M)	3 pole XLR (M)
ON/OFF SWITCH	-	-
USE	Speech (table top)	Speech (table top)

MD 7600

DYNAMIC MICROPHONE

p/n 141.15.014



290 g

EASYLINE
SOLUTIONS

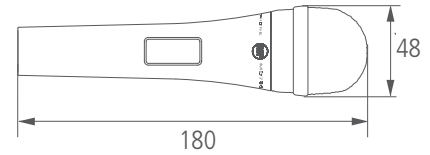

- Typical use: speech, singing
- Supercardioid dynamic microphone
- Anti-pop filter
- ON/OFF switch with lock
- Minimum handling noise
- 5 metre balanced and screened cable with 3 pole XLR connectors included
- Mic. holder for stands and soft bag included

SPECIFICATIONS

TYPE

IMPEDANCE

SENSITIVITY

FREQUENCY RESPONSE

CONNECTORS

MD 7600

DYNAMIC, SUPERCARDIOID

500 Ω \pm 30% (1 kHz)

- 75 dB \pm 3 dB (0 dB=1V/ μ bar, 1kHz)

60 \div 16000 Hz

3 pole XLR (m)

MD 7800

PROFESSIONAL DYNAMIC MICROPHONE

p/n 141.15.013



305 g

\updownarrow mm

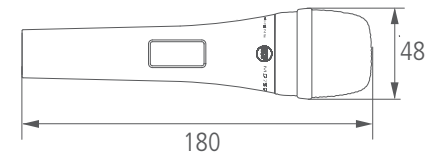

- Typical use: speech, singing
- Professional supercardioid dynamic microphone
- Anti-pop filter
- ON/OFF switch with lock
- Minimum handling noise
- 5 metre balanced and screened cable with 3 pole XLR connectors included
- Mic. holder for stands and soft bag included

SPECIFICATIONS

TYPE

IMPEDANCE

SENSITIVITY

FREQUENCY RESPONSE

CONNECTORS

MD 7800

DYNAMIC, SUPERCARDIOID

600 Ω \pm 30% (1 kHz)

- 70 dB \pm 3 dB (0 dB=1V/ μ bar, 1kHz)

60 \div 20000 Hz

3 pole XLR (m)

MC 4064

p/n. 141.15.025

GOOSENECK MICROPHONE
(DESK-TOP / ON FLOOR STAND)



200 g

↕ mm

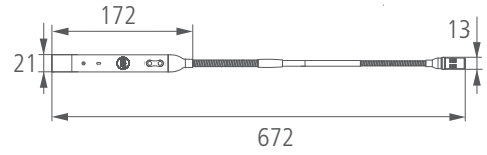

- Double joint gooseneck, 672 mm long
- Installation on desks (with or without hole), lecterns, mic. floor stands
- It has two switches (PUSH, LOCK), a red ring lamp that is lit when the microphone is activated, a high-pass filter with a switch to cut frequencies below 100 Hz.
- Phantom power supply (12 ÷ 52 V)
- 3 m screened and balanced cable with XLR connectors for linking to a mixer / amplifier, with 2 additional wires for command
- Polyurethane foam wind screen

SPECIFICATIONS

TYPE	MC 4064 ELECTRET, CARDIOID
IMPEDANCE	600 Ω BALANCED
FREQUENCY RESPONSE	50 ÷ 18000 Hz
SENSITIVITY	- 58 dB ± 3 dB (0 dB=1V/μbar, 1kHz)
CONNECTOR	3 pole XLR (m)

AC MIC DK

p/n 133.60.247

TABLE BASE FOR
MICROPHONE MC 4064



- Standard connection 5/8
- Diameter: 160 mm
- Weight: 1 Kg

MT 3100 MT 3200

p/n 141.10.079

p/n 141.10.080

DESK-TOP MICROPHONES



MT 3100 OMNIDIRECTIONAL



MT 3200 SEMICARDIOID

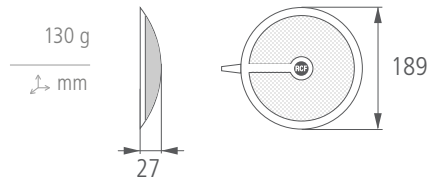

- Resistant plastic body with metal mesh and base
- Red LED lit when the microphone is ON
- Electronic filter for suppressing noise caused by vibrations transmitted from the support surface
- Phantom power supply (12 ÷ 52 V dc)
- 5 m screened and balanced cable with 3 pole XLR connectors
- Dimensions: Ø120 x 27mm (h)
- Colour:
RAL 7021 anthracite grey (MT 3100)
RAL 9003 white (MT 3200)

SPECIFICATIONS

TYPE	MT 3100 - 3200 ELECTRET, OMNIDIRECTIONAL (MT 3100), SEMICARDIOID (MT 3200)
IMPEDANCE	600 Ω BALANCED
FREQUENCY RESPONSE	50 ÷ 18000 Hz
SENSITIVITY	- 54 dB ± 3 dB (0 dB=1V/μbar, 1kHz)
CONNECTORS	3 pole XLR (m)

EASYLINE
SOLUTIONS

TX 2006

p/n 142.50.007

UHF DIVERSITY SYSTEM - HAND HELD TX



EASYLINE
SOLUTIONS

PX 2106

p/n 142.50.009

UHF DIVERSITY SYSTEM - POCKET TX



Each receiver has 2 antennas for smart switching diversity control (the higher level radio signal is automatically selected), greater reliability and coverage, reduced risks of breakdowns and interferences. 16 different frequencies / channels are available. It is possible to use up to 6 channels simultaneously (when having 6 wireless microphone kits).

Channels can be manually selected on all transmitters and receivers.

SPECIFICATION

CHANNEL	TX 2006 - PX 2106
TYPE	SINGLE
FREQUENCY BAND	(PLL) UHF, 'DIVERSITY' RECEIVER
FREQUENCY RESPONSE	UHF, 638 ÷ 662 MHZ
FREQUENCY STABILITY	50 HZ ÷ 50 KHZ (± 3 DB)
MODULATION MODE	± 0.005 %
DYNAMIC	FM (F3E)
RX 2006 RECEIVER	> 100 DB
T.H.D.	< 1 %
AUDIO OUTPUT	280 MV @ ± 15 KHZ DEVIATION
S/N RATIO	> 90 DB
RF SENSITIVITY	- 100 DBM / 30 DB SINAD
POWER SUPPLY	THROUGH EXTERNAL 12 V DC (0.5A) ADAPTER
DIMENSIONS	130 MM (W), 44 MM (H), 201 MM (D)
NET WEIGH	0.37 KG
TRANSMITTER / HANDHELD MICROPHONE TX 2000 - POCKET PX 2100	
RF OUTPUT POWER	10 MW
TONE FREQUENCY	32,768 kHz
CURRENT ABSORPTION	< 150 MA
MAX. DEVIATION	± 35 kHz
PILE	2 x TIPO 'AA' (1,5 V; NON RECHARGEABLE)
TX 2000 TYPE	DYNAMIC MICROPHONE
PX 2100 TYPE	'LAVALIER' (TIE-CLIP) ELECTRET MICROPHONE
DIMENSIONS TX 2000	(L) 220 mm
DIMENSIONS PX 2100	65 mm (L), 111 mm (H), 31 mm (P)
NET WEIGH	(TX 2000) 0,16 Kg - (PX2100) 0,11 Kg

HE 2006

p/n 141.15.023

'HEADSET' MICROPHONE

EASYLINE
SOLUTIONS

'Headset' type, reliable and light.

Cardioid electret capsule.

It ensures an excellent isolation from environmental noise.

Typical use: dancers, singers, djs, aerobic instructors, presenters, actors, etc.

The optimal use of the microphone requires a distance between the capsule and mouth of about 25 mm.



TX 4016

p/n 142.50.008

UHF TRUE DIVERSITY SYSTEM - HAND HELD TX



PX 4116

p/n 142.50.010

UHF TRUE DIVERSITY SYSTEM - POCKET TX



Each receiver has 2 antennas for smart switching diversity control (the higher level radio signal is automatically selected), greater reliability and coverage, reduced risks of breakdowns and interferences. The operating frequency of the transmitter can be automatically searched thanks to the receiver auto-scan function. Of course, it is possible to match the transmitter channel to the receiver one manually. 144 channels are available (12 groups, each with 12 different frequencies). It is possible to use up to 16 channels simultaneously (when having 16 wireless microphone kits).

SPECIFICATION

TX 4016 - PX 4116

CHANNEL	SINGLE (OUT OF 144 FREQUENCIES)
TYPE	(PLL) UHF, 'DIVERSITY' RECEIVER
FREQUENCY BAND	UHF, 638 MHZ ÷ 662 MHZ
FREQUENCY RESPONSE	50 HZ ÷ 50 KHZ (± 3 DB)
FREQUENCY STABILITY	± 0.005 % (-10 ÷ 50°C)
T.H.D.	< 0.8% (1 KHZ)
MODULATION MODE	FM (F3E)
DYNAMIC	> 100 DB
RX 4016 RECEIVER	
BALANCED AUDIO OUTPUT	1 V, ± 35 KHZ DEVIATION
UNBALANCED AUDIO OUTPUT	750 MV, ± 35 KHZ DEVIATION
S/N RATIO	> 90 DB
RF SENSITIVITY	- 100 DBM / 30 DB SINAD
POWER SUPPLY	THROUGH EXTERNAL 15 V DC (0.5A) ADAPTER
DIMENSIONS	210 MM (W), 44 MM (H), 155 MM (D); (8.2" X 1.7" X 6.1")
NET WEIGHT	0.99 KG
TRANSMITTER / HANDHELD MICROPHONE TX 4000 - BODY PACK TRANSMITTER PX 4100	
RF OUTPUT POWER	1 - 3 - 10 mW
FREQUENCY RESPONSE	(TX 4000) 90 Hz ÷ 12 kHz (± 3 DB) (PX 4100) 50 Hz ÷ 15 kHz (± 3 dB)
TX 4000 TYPE	DYNAMIC, CARDIOID
PX 4100 TYPE	ELECTRET MICROPHONE
tone frequency	30-33 kHz
MAX. DEVIATION	± 35 kHz
BATTERIES	2 x TIPO 'AA' (1,5 V; NON RECHARGEABLE)
DIMENSIONS TX 4000	277 mm (L), Ø 36.5 mm
DIMENSIONS TX PX 4100	97 mm (L), 68 mm (H), 22 mm (P)
NET WEIGHT	(TX 4000) 0,25 Kg - (PX4100) 0,01 Kg

HE 2006

p/n 141.15.023

'HEADSET' MICROPHONE



'Headset' type, reliable and light.
Cardioid electret capsule.

It ensures an excellent isolation from environmental noise.

Typical use: dancers, singers, djs, aerobic instructors, presenters, actors, etc.

The optimal use of the microphone requires a distance between the capsule and mouth of about 25 mm.



BM 3001 PAGING MICROPHONE

p/n 143.22.008

700 g

↕ mm

BM 3003 3 ZONE PAGING MICROPHONE

p/n 143.22.012

600 g

↕ mm

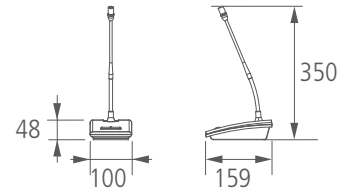

- Plastic body with 300 mm gooseneck
- Polyurethane foam wind screen
- [only BM 3001] It can be directly connected to ES 3160, ES 3323, AM 2080, AM 2160, AM 2320, UP 2081, UP 2161, UP 2321.
- ES 3160, AM 2160, AM 2320 chime activation
- PTT button with LED
- 5 m connecting cable (with RJ 45 plugs) included

solo BM 3003:

- 3 zone selection push buttons with LED
- Two colours LED indicating power supply and busy status
- It can be directly connected to ES 3323 amplifiers
- The power voltage for the first BM 3003 connected to the units is supplied by the ES 3323
- Line of max.12 BM 3003 paging microphones can be connected to the ES 3323 by using an additional power supply unit 24 V dc (AC AD2505, not included)
- BM 3003 works only with ES 3323

SPECIFICATIONS

	BM 3001	BM 3003
TYPE	ELECTRET, CARDIOID	ELECTRET, CARDIOID
IMPEDANCE	470 Ω BALANCED	470 Ω BALANCED
FREQUENCY RESPONSE	50 ÷ 18000 Hz	50 ÷ 18000 Hz
SENSITIVITY	- 65 dB ± 3 dB (0 dB=1V/μbar, 1kHz)	- 65 dB ± 3 dB (0 dB=1V/μbar, 1kHz)
CONNECTORS	8 pole RJ 45	2 x 8 pole RJ 45

EASYLINE
SOLUTIONS

BM 3014 PAGING MICROPHONE

p/n 143.20.135

1'600 g

↕ mm

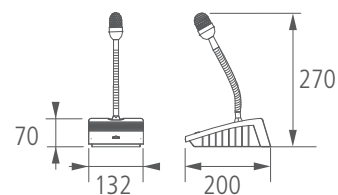

- Plastic body with 320 mm gooseneck
- Pushbutton for momentary microphone activation
- 5 m screened and balanced cable with XLR connectors for linking to a mixer / amplifier, with 2 additional wires for command

SPECIFICATIONS

	BM 3014
TYPE	DYNAMIC, CARDIOID
IMPEDANCE	500 Ω BALANCED
FREQUENCY RESPONSE	100 ÷ 12000 Hz
SENSITIVITY	- 71 dB ± 3 dB (0 dB=1V/μbar, 1kHz)
CONNECTORS	3 pole XLR

MC 5030

DESK-TOP MICROPHONE

p/n 141.15.005



295 g

↕ mm

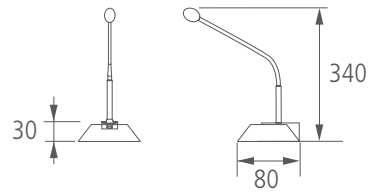

- Compact die-cast metal base with gooseneck
- Locking pushbutton with LED for microphone activation
- Power supplied by 'Phantom' (12 ÷ 48 V dc)
- 3 m screened and balanced cable with XLR connectors for linking to a mixer / amplifier, with 2 additional wires for command
- Polyurethane foam wind screen

SPECIFICATIONS

TYPE

IMPEDANCE

FREQUENCY RESPONSE

SENSITIVITY

CONNECTORS

MC 5030

ELECTRET, CARDIOID

200 Ω BALANCED

80 ÷ 14000 Hz

- 75 dB ± 3 dB (0 dB=1V/μbar, 1kHz)

3 pole XLR

BM 3022

PRE-AMPLIFIED DESK TOP MICROPHONE

p/n 143.22.013



600 g

↕ mm

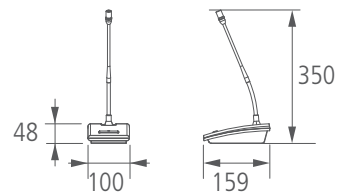

- Gooseneck microphone with hi-quality unidirectional electret capsule
- Direct connection to power amplifiers input through CAT5 cable
- Adjustable line output with RJ45 connector
- Switchable automatic gain control (AGC)
- Up to 30 BM 3022 paging microphones can be linked in a 'daisy-chain'
- Selectable mixing, interlocking or priority mode among devices
- When activating a microphone, the announcement can be preceded by a chime.

SPECIFICATIONS

TYPE

IMPEDANCE

FREQUENCY RESPONSE

SENSITIVITY

CONNECTORS

BM 3002

ELECTRET

130 Ω BALANCED

200 ÷ 7000 Hz

- 65 dB ± 3 dB (0 dB=1V/μbar, 1kHz)

2 x RJ 45 (IN - OUT)

MC 5054

FLEXIBLE UNIVERSAL
MICROPHONE

p/n 141.15.024



Flexible microphone, 445 mm length. Installation on microphone plug with XLR connector. Male 3 pin XLR output connector. Phantom power 9 V to 52 V.

Polyurethane anti wind foam. Electret, Cardioid.

Impedance: $200 \Omega \pm 30\%$ (at 1.000 Hz).

Frequency response: $50 \div 18.000$ Hz.

Sensitivity: $-65 \text{ dB} \pm 3 \text{ dB}$ ($0 \text{ dB} = 1 \text{ V}/\mu\text{bar}$ 1.000 Hz)

Dimensions: diameter 19x540 mm.

AC 112DK

UNIVERSAL XLR
DESKTOP MICROPHONE

p/n 143.80.018



Die cast zinc desktop base with activation button. Female 3 pin XLR microphone connector. Male 3 pin XLR connector for output cable. Dimensions: 162x112x47 mm. Weight 1.5 Kg.

AC 503FS

MC 5054 ADAPTOR FOR FLOOR
MICROPHONE STAND

p/n 143.80.033



Universal extended metal stand. Female 3 pins XLR microphone connector.

Installation with screws on a table, a bookstand or a microphone stand. Button for stable and unstable microphone insertion. Screw thread $5/8'' \times 27$ mm.

1,5 m cable (with 3 pin, male XLR) for amplifier connection

Dimensions: diameter 20,5 x 199,3 mm.

AC 502LC

MC 5054 ADAPTOR FOR
PLATFORMS

p/n 143.80.034



Universal table metal support. Female 3 pin XLR connector.

Installable on a bookstand with or without a cable hole.

Welding terminal for cable. Dimensions: diameter 45x63 mm.

OT 3500

TRANSFORMER FOR DISTRIBUTED SYSTEMS

p/n 171.20.056



Mumental insulation tranformer with removeable screw terminals. Can work with 0dB signals.

AR 1620

RACK MOUNTING ACCESSORY

p/n 173.60.031



1U 19" rack kit suitable for 1 or 2 receivers (models: RX 1000 or RX 1600).

MD 6000-X

HAND MICROPHONE

p/n 141.15.021



Unbalanced unidirectional handheld microphone optimised for voice reproduction. On/off pushbutton incorporated in the shockproof plastic body. Colour: black

A 504-N

MIC SUPPORT

p/n 143.80.014



Microphone support ($5/8''$ thread).

Suitable for use with the MD 7600, MD 7800 microphones on AC S64FL, AC S62FL and AC S50DK supports.

A 507

MIC. SUPPORT

P/n 143.10.008



Universal quick-release clamp holder for holding cylindrical, conical, and polyhedron shaped microphones.

Clamp opening: from 15 to 38 mm. Suitable for use with TX 1000 / TX 1600 / TX 516 wireless mic. on AC S64FL, AC S62FL and AC S50DK supports.

AC S50DK

DESKTOP STAND

P/n 143.80.011



Desk top microphone stand with die-cast base, suitable for 5/8" or 3/8" thread. Tilting telescopic rod, adjustable from 38 cm to 58 cm. Weight: 2 Kg. Height: min/max 38cm/58cm. Base dimensions 16x18cm

AC XLR-3M3F

CONNECTORS

P/n 133.60.102



3 XLR Female connector with nickel body and silver contacts
- 3 XLR Male connector with nickel body and silver contacts

2+2/C

AUDIO CABLE

P/n 143.40.013



4 Pole cable, 2 shielded wire and 2 unshielded, available in 200 meters coils (code refers to 1 meter cable)

CA 5XX

MIC. CABLE

P/n 143.40.017



5 m microphone cable with XLR connectors.

AC S76FL

FLOOR STAND

P/n 143.80.027



Floor microphone stand with folding base, suitable for 5/8" thread. Joints and legs in die-cast aluminium. Steel telescopic rod, adjustable from 96 cm to 156 cm. Tilting steel boom-arm, adjustable from 46 cm to 86 cm. Damping base with 58 cm limited opening diameter. Weight: 3.2 Kg. Length once folded: 102 cm

AC AD 2405

24 V ADAPTOR

P/n 143.80.022



Power adaptor for 24 V DC paging microphones

- input 230V AC
- output 24 V DC - 500 mA

2/C

AUDIO CABLE

P/n 143.40.012



2 Pole shielded cable, available in 200 meters coils (code refers to 1 meter cable)

MP 300

OPERATOR/USER INTERCOM
SYSTEM KIT

p/n 121.70.094

- MP 300 system allows conversations between an operator and users /clients when these are separated by a safety glass that reduces the sound transmission
- Operates in full-duplex mode, automatic or mixed-switching depending on the ambient noise in the room / hall served.
- On request, each single component can be purchased separately

MODEL	P/N	DESCRIPTION	QUANTITY
MP 341	124.01.005	Control unit / amplifier	1
MP 321	124.01.008	Operator microphone console with activation keys	1
MP 302	124.01.007	User microphone	1
MP 301	124.01.006	Loudspeaker	4



SPECIFICATIONS

MICROPHONES	MP 300 ELECTRET, UNIDIRECTIONAL
AMPLIFIER POWER	2 W (per each line)
ADDITIONAL LOUDSPEAKER OUTPUT	1 W - 8 Ω
POWER SUPPLY (AC)	230 / 115 V (50 / 60 Hz)
POWER SUPPLY (DC)	12 V

MP 321

OPERATOR MICROPHONE

P/n 124.01.008

800 g

↕ mm

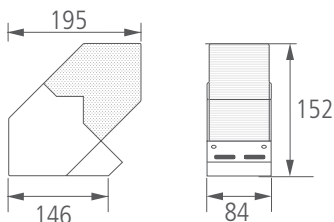

- Electret microphone with unidirectional polar pattern, housed into an anthracite grey die-cast aluminium alloy and protected by a painted stainless steel grille
- Equipped with 2 push-buttons to activate the operator-user line and the user-operator line respectively
- A LED indicates which line is activated
- It can be remote controlled (e.g. through a pedal switch)

MP 302

USER MICROPHONE

p/n 124.01.007

3.5 g
mm

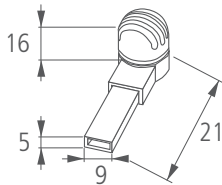

- Electret microphone having high sensitivity and an unidirectional polar pattern, suitable for clear voice reproduction even in very noisy rooms / halls
- Its compact white plastic enclosure has a very sleek contemporary design
- MP 302 has a slot (close to the audio cable output) for the insertion of a standard wiring duct
- It can be easily attached on safety glasses through bi-adhesive tape
- 5 m balanced and screened cable for connection to the MP 341 control unit / amplifier

MP 301

LOUDSPEAKERS

p/n 124.01.006

120 g
mm

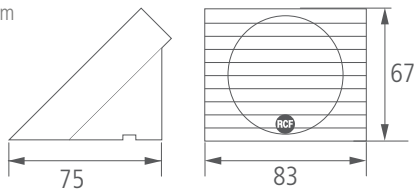

- MP 301 loudspeakers shall be installed near the microphones of the operator and users
- White plastic body
- 70 mm loudspeaker suitable for voice reproduction
- Loudspeakers can be fixed by using biadhesive tape (included)
- 5m loudspeaker cables for connection to the MP 341 control unit / amplifier

MP 341

CONTROL UNIT / AMPLIFIER

p/n 124.01.005

1'400 g
mm

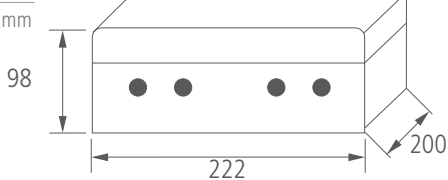

- It is the system main unit that manages audio signals coming from microphones.
- 4 switches inside (with LEDs) allow to select one of the 4 operating modes, according to the noise level at the operator's microphone and at the users' microphone. A switch for each line makes it possible to select either the 'direct' function (the line is always activated) or the 'switched' mode (the line is momentary activated when speaking). If both lines are set to the 'switched' mode, only one can be activated at a time. The other 2 switches enable the 'forced volume' function of each line, useful whenever it is necessary to increase (+ 10 dB) the audio level
- It is possible to adjust the listening volume of each position independently, as well as the trigger threshold level of each microphone (factory preset)
- Its plastic enclosure can be wall mounted

AUDIO SOURCES

CD players, Radio receivers, message players for every hi-fidelity listening need.



RD 2016

p/n 171.70.168

MP3 AUDIO FILES DIGITAL
RECORDER/PLAYER



- MP3 stereo player/recorder
- Supports SD cards and USB flash drives
- 32 GB Maximum supported memory
- Can play/record one file at a time
- A sequence of 64 file can be programmed
- Fixed MP3 recording format: 192 kbps
- 1 AUX INPUT with parallel AUX OUTPUT
- Disabled front buttons
- IR remote control included
- SD Card not included

REAR VIEW

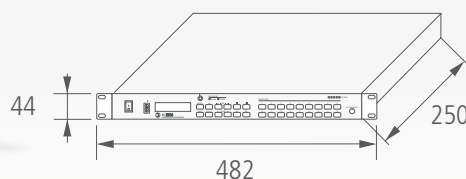
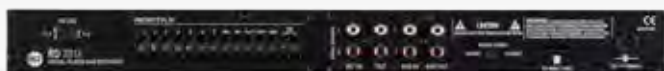

3'000 g
mm

SPECIFICATIONS

AUDIO OUTPUT LEVEL
DISTORTION (THD+N)
SIGNAL/NOISE RATIO
CHANNEL SEPARATION
NUMBER OF MESSAGES
MESSAGES LENGTH
POWER SUPPLY
OUTPUT CONNECTORS

RD 2016

+2 dBu ± 2 dB
< 0,2 %
> 70 dB
> 60 dB
16 (7 remotely activable)
Depending on the device capability
12 V c.c., 0,5 A (100 ÷ 240 V c.a. 50/60 Hz, 0,2 A power supply included)
RCA (L&R)

MS 1033

p/n 171.70.108

CD-USB MP3 PLAYER WITH
FM RADIO TUNER



- Double sound source with two independent sections and outputs (Tuner - CD/Mp3)
- CD player to reproduce audio tracks and MP3 files from a compact disc (CD, CD-R, CD-R/W) or from the USB drive ("Flash" memory-stick with only MP3 files)
- The USB port is available on both front and back panels to provide maximum flexibility
- The SD card port is available on front panels
- LCD backlit display gives information on the CD and MP3 files
- I/R remote control for CD and Tuner included
- FM radio tuner (87.5 - 108 MHz) with possibility to memorize your 30 favourite radio stations
- Stereo / Mono selector for applications where stereo signals are not needed
- LCD backlit display shows the frequency and stations that are in the memory

REAR VIEW

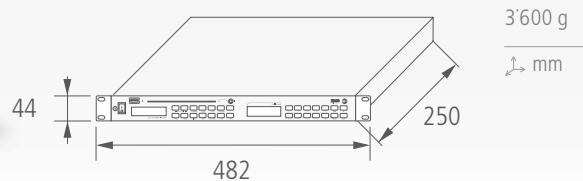

SPECIFICATIONS

SPECIFICATIONS	MS 1033
AUDIO OUTPUT LEVEL	+4 dBu ± 2 dBu (1.2 V ± 0.2 V)
FREQUENCY RESPONSE	20 ÷ 20.000 Hz (CD); 100 ÷ 12.000 Hz (RADIO)
DISTORTION (THD+N)	< 0.1% (CD); < 0.8% (RADIO)
FREQUENCY RANGE	87.5 ÷ 108 MHz (FM)
SIGNAL TO NOISE RATIO	> 70 dB (CD); > 60 dB (RADIO)
CHANNEL SPLIT	≥ 60 dB (CD); ≥ 30 dB (RADIO)
SENSITIVITY	≤ 10 V
SUPPLY VOLTAGE	220 ÷ 240 V / 110 ÷ 120 V (50 / 60 Hz)
OUTPUT CONNECTORS	RCA (L&R RADIO); RCA (L&R CD USB/MP3); RCA (L&R MIXED)

AMPLIFIERS AND PREAMPLIFIERS

For constant voltage systems or professional audio applications.



MODEL	ES 3323-II	ES 3160-II	ES 3080
OUTPUT RMS POWER	320 W	160 W	80 W
OUTPUT	4 Ω (2W max), 100 V, 70 V	4 Ω, 100 V, 70 V	4 Ω, 100 V, 70 V
FREQUENCY RESPONSE	50 ÷ 18.000 Hz	50 ÷ 18.000 Hz	50 ÷ 18.000 Hz
DISTORTION @ 1 kHz	< 0.3%	< 0.3%	< 0.3%
SIGNAL TO NOISE RATIO	> 65 dB	> 65 dB	> 60 dB
INPUT SENSITIVITY	(MIC) -60 dBu; (AUX) -80 dBu	(MIC) -60 dBu; (AUX) -80 dBu	(MIC) -62 dBu; (AUX) -18 ÷ +20 dBu
INPUT IMPEDANCE	(MIC) 10 KΩ; (AUX) 20 KΩ	(MIC) 10 KΩ; (AUX) 20 KΩ	(MIC) 10 KΩ; (AUX) 20 KΩ
INPUT CONNECTORS	1 x XLR, 2 x RJ45, 4Term., 1 RCA	1 x XLR, 2 x RJ45, 4Term., 1 RCA	1 x XLR, 1 x RJ45, 2 Term, 1 RCA
OUTPUT CONNECTORS	4 x RCA, Screw terminal	4 x RCA, Screw terminal	2 x RCA (mono)



MODEL	AM 2160 - AM 2320	AM 2080	UP 1121
OUTPUT RMS POWER	160 W / 320 W	80 W	120 W
OUTPUT	4 Ω, 100 V, 70 V	4 Ω, 100 V, 70 V	4 Ω, 100 V, 70 V
FREQUENCY RESPONSE	50 ÷ 18.000 Hz	50 ÷ 18.000 Hz	60 ÷ 15.000 Hz
DISTORTION @ 1 kHz	< 0.3%	< 0.3%	< 1.5%
SIGNAL TO NOISE RATIO	> 60 dB	> 60 dB	> 80 dB
INPUT SENSITIVITY	(MIC) -58 dBu; (LINE) 0 dBu	(MIC) -62 dBu; (LINE) 0 dBu	(LINE) 2 dBu
INPUT IMPEDANCE	(MIC) 10 KΩ; (AUX) 20 KΩ	(MIC) 10 KΩ; (AUX) 20 KΩ	(MIC) 10 KΩ
INPUT CONNECTORS	1 x XLR, 2 x RJ45, 4 Term., 4 RCA	1 x XLR, 2 x RJ45, 4 Term.	Balanced 'line' level AUDIO INPUT (terminal strip)
OUTPUT CONNECTORS	4 x RCA, Screw terminal	4 x RCA, Screw terminal	Screw terminal



MODEL	UP 2081 / UP 2161 / UP 2321	UP 2082 / UP 2162	AM 1125
OUTPUT RMS POWER	80W / 160 W / 320 W	2 x 80W / 2 x 160 W	120 W
OUTPUT	4 Ω, 100 V, 70 V	4 Ω, 100 V, 70 V	4 Ω, 100 V, 70 V
FREQUENCY RESPONSE	50 ÷ 18.000 Hz	50 ÷ 18.000 Hz	50 ÷ 15.000 Hz
DISTORTION @ 1 kHz	< 0.3%	< 0.3%	< 1.5%
SIGNAL TO NOISE RATIO	> 80 dB	> 80 dB	> 85 dB
INPUT SENSITIVITY	(MIC) -58 dBu; (LINE) 0 dBu	(MIC) -58 dBu; (LINE) 0 dBu	(MIC) -54 dBu; (LINE) -12 dBu
INPUT IMPEDANCE	(MIC) 10 KΩ; (AUX) 20 KΩ	(MIC) 10 KΩ; (AUX) 20 KΩ	(MIC) 600 Ω; (AUX) 10 KΩ
INPUT CONNECTORS	1 x XLR, 1 x RJ45, 1 Screw terminal	1 Screw terminal	MIC/LINE with XLR connector, 'Phantom' power supply, priority by contact or 'VOX'
OUTPUT CONNECTORS	1 x RCA, Screw terminal	1 x RCA, Screw terminal	Screw terminal



MODEL	UP 8501	UP 8502	UP 8504
OUTPUT RMS POWER	1 X 500 W	2 X 250 W	4 X 125 W
OUTPUT	100 V, 70 V	100 V, 70 V	100 V, 70 V
FREQUENCY RESPONSE	20 HZ ÷ 20 KHZ	20 HZ ÷ 20 KHZ	20 HZ ÷ 20 KHZ
DISTORTION @ 1 kHz	< 0.3%	< 0.3%	< 0.3%
SIGNAL TO NOISE RATIO	> 86 dB	> 86 dB	> 86
INPUT SENSITIVITY	0 DBU (775 MV, MAX. 7 V)	0 DBU (775 MV, MAX. 7 V)	0 DBU (775 MV, MAX. 7 V)
INPUT IMPEDANCE	10 KΩ	10 KΩ	10 KΩ
INPUT CONNECTORS	Screw terminal	Screw terminal	Screw terminal
OUTPUT CONNECTORS	Screw terminal	Screw terminal	Screw terminal

ES 3323-II

p/n 121.35.105

320 W, 3-ZONE MIXER AMPLIFIER,
CD/USB/BLUETOOTH MP3 PLAYER



- CD-USB/MP3 Player / FM tuner / Mixer Amplifier
- Bluetooth connection with external devices
- IR Remote control for CD - USB/MP3 player & tuner functions
- Full digital technology amplifier 320 W RMS, 100V-70V
- Low impedance (min. 4 Ω) 2 W output for a monitor loudspeaker is available
- 4 universal inputs with phantom facility, Presence Control and per-channel High-Pass filters
- RJ45 connectors on input 2 and 3 for connection to BM3001 and BM 3003 microphone
- Screw terminal connections, additional XLR and RJ45 input connections available
- Configurable Priority settings, VOX facility on input 1
- Selectable aux input for music source with volume and tone controls
- USB port on front panel allows reproduction of MP3 files from a memory stick
- Music On Hold and PRE outputs
- The 3 PAGING buttons to select zones to be paged by either the channel 1 or 4
- GENERAL call button is available
- The 3 MUSIC buttons turn the music on in the respective zones
- Digital Chime and Siren built-in generator, activation through dry contact
- Status / Priority / Audio Level LED indications
- Link to a external amplifier (i.e. RCF UP 2321) to keep the music in the zones that are not paged

REAR VIEW

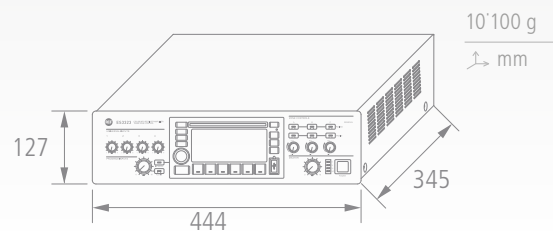

SPECIFICATIONS

SPECIFICATIONS	ES 3323
OUTPUT POWER	320 W
FREQUENCY RESPONSE	50 - 18.000 Hz (± 3 dB)
DISTORTION (THD+N)	< 0,3% @ 1 kHz
SPEAKER OUTPUTS	100 V, 70 V, 4 Ω (MONITOR MAX 2 W)
AUXILIARY OUTPUTS	600 Ω , -1 dBu (690 mV)
SIGNAL TO NOISE RATIO	> 65 dB (INPUTS 1-4); > 75 dB (AUX IN); > 85 dB (MAIN IN)
INPUT SENSITIVITY	(MIC) -58 dBu (1 mV); (MIC PHANTOM) -28 dBu (30 mV); (AUX) -11 \div +10 dBu (0.2 \div 2.5 V)
INPUT IMPEDANCE	(MIC) 10 k Ω ; (AUX) 20 k Ω (MIC) 10 k Ω ; (MIC PHANTOM) 6.5 k Ω ; (LINE): 10 k Ω ; (AUX): 20 k Ω
SUPPLY VOLTAGE	220 \div 240 V / 110 \div 120 V (50 / 60 Hz) INTERNAL SETTING
POWER CONSUMPTION	600 W
INPUT CONNECTORS	1 x XLR, 2 x RJ 45, 4 x TERMINAL, 2 x RCA stereo
OUTPUT CONNECTORS	4 x RCA (MUSIC ON HOLD, PRE-OUT, INTERNAL PROGRAM), SCREW TERMINALS FOR CONSTANT VOLTAGE LINES

BM 3003

p/n 143.22.012

3 ZONE PAGING MICROPHONE



The paging microphone allows to make selective calls to 3 zones and is the ideal complement of the ES 3323 mixer amplifier (through CAT 5 cable and RJ 45 connector)

AR 3000

p/n 133.60.101

RACK SUPPORT

Rack mounting support, 3U.

ES 3160-II

160W AMPLIFIER,
CD-USB-BLUETOOTH/MP3

p/n. 121.35.104



- Mixer amplifier, CD-USB/MP3 player – FM tuner
- Bluetooth connection with external devices
- IR remote control for CD - USB/MP3 player and tuner functions
- Full digital technology 160 W RMS amplifier, 70 – 100 V / 4 Ω outputs
- 4 universal inputs for removable screw-terminals and with phantom power supply, high-pass filters facility and a common presence control
- RJ45 ports on inputs 2 and 3 for connections of BM 3001 paging microphones
- Configurable priority settings, VOX facility on input 1
- Aux input with volume and tone controls for an external music source
- USB port on front panel allows reproduction of MP3 files from a flash-drive
- Music On Hold and PRE outputs
- Chime and siren internal generator, activation through dry contacts
- Status / Priority / Audio Level LED indications

REAR VIEW

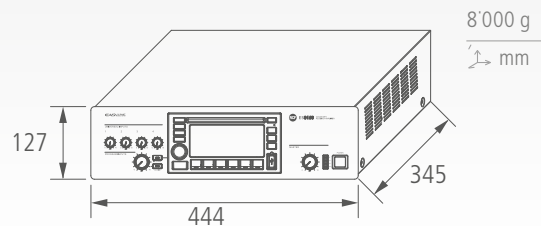

SPECIFICATIONS

SPECIFICATIONS	ES 3160
OUTPUT POWER	160 W
FREQUENCY RESPONSE	50 ÷ 18.000 Hz (± 3 dB)
DISTORTION (THD+N)	< 0.3% @ 1 kHz
SPEAKER OUTPUTS	100 V, 70 V, 4 Ω
AUXILIARY OUTPUTS	600 Ω, -1 dBu (690 mV)
SIGNAL TO NOISE RATIO	> 65 dB (INGRESSO 1-4); > 75 dB (AUX IN); > 85 dB (MAIN IN)
INPUT SENSITIVITY	(MIC) -58 dBu (1 mV); (MIC PHANTOM) -28 dBu (30 mV); (AUX) -11 ÷ +10 dBu (0.2 ÷ 2.5 V)
INPUT IMPEDANCE	(MIC) 10 KΩ; (AUX) 20 KΩ (MIC) 10 kΩ; (MIC PHANTOM) 6.5 kΩ; (LINE): 10 kΩ; (AUX): 20 kΩ
SUPPLY VOLTAGE	220 ÷ 240 V / 110 ÷ 120 V (50 / 60 Hz) INTERNAL SETTING
POWER CONSUMPTION	350 W
INPUT CONNECTORS	1 x XLR, 2 x RJ 45, 4 x TERMINAL, 2 x RCA stereo
OUTPUT CONNECTORS	4 x RCA (MUSIC ON HOLD, PRE-OUT, INTERNAL PROGRAM), SCREW TERMINALS FOR CONSTANT VOLTAGE LINES

BM 3001

MICROPHONE CONSOLE

p/n 143.22.008



Dedicated microphone console with Cat5 connection cable and RJ45 connector.

AR 3000

RACK SUPPORT

p/n 133.60.101

Rack mounting support, 3U.

ES 3080

AUDIO SOURCE

p/n 121.35.107



SPECIFICATIONS

OUTPUT POWER	80 W
FREQUENCY RESPONSE	50 - 18.000 Hz (\pm 3 dB)
DISTORTION (THD+N)	< 0,3% @ 1 kHz
SPEAKER OUTPUTS	100 V, 70 V, 4 Ω
SIGNAL TO NOISE RATIO	> 60 dB (INPUTS 1-2); > 80 dB (AUX IN)
INPUT SENSITIVITY	(MIC) -62 dBu (1 mV); (MIC PHANTOM) -28 dBu (30 mV); (AUX) -18 \div +20 dBu (0.1 \div 7 V)
INPUT IMPEDANCE	(MIC) 10 k Ω ; (MIC PHANTOM) 10 k Ω ; (AUX) 20 k Ω
SUPPLY VOLTAGE	220 \div 240 V / 110 \div 120 V (50 / 60 Hz) INTERNAL SETTING / 80 W
INPUT CONNECTORS	1 x XLR, 1 x RJ 45 FOR BM 3001, 2 x TERMINAL, 1 x RCA

- Audio source with 80W power amplifier.
- MP3 player controlled from the front panel.
- MP3 inputs: USB flash, SD card, AUX jack 3.5mm.
- Bluetooth connection with external devices
- 2 universal inputs on removable screw-terminals and 1 AUX input.
- Configurable priority settings, VOX facility on input 1
- Auxiliary output MUSIC ON HOLD to send the audio signal to external amplifiers or telephone switchboards.
- PRE OUT connector for additional power amplifiers.
- HI-PASS control (inputs 1 and 2)
- Auxiliary input on RCA connector and front panel are equipped with independent tone controls (bass and treble) and gain.
- Status LEDs on the front panel (ON, PROT) giving a complete feedback on amplifier and power supply status.
- LEDs on the front panel (PRIOR) indicating the priority circuit activity and the audio signal level (SIG/PK).
- Integrated alert sound generator configurable as single or double tone.
- Rack mount kit for 2 units amplifiers included

ES 3080

AM 2080

INTEGRATED AMPLIFIER

p/n 121.35.062



SPECIFICATIONS

OUTPUT POWER	80 W
FREQUENCY RESPONSE	50 - 18.000 Hz (\pm 3 dB)
DISTORTION (THD+N)	< 0,3% @ 1 kHz
SPEAKER OUTPUTS	100 V, 70 V, 4 Ω
SIGNAL TO NOISE RATIO	> 60 dB (INPUTS 1-2); > 80 dB (AUX IN)
INPUT SENSITIVITY	(MIC) -62 dBu (1 mV); (MIC PHANTOM) -28 dBu (30 mV); (AUX) -18 \div +20 dBu (0.1 \div 7 V)
INPUT IMPEDANCE	(MIC) 10 k Ω ; (MIC PHANTOM) 10 k Ω ; (AUX) 20 k Ω
SUPPLY VOLTAGE	220 \div 240 V / 110 \div 120 V (50 / 60 Hz) INTERNAL SETTING
INPUT CONNECTORS	1 x XLR, 1 x RJ 45, 2 x TERMINAL, 2 x DOUBLE RCA (AUX)

- 80 W mixer-amplifier, with 2 mic-line audio inputs on removable connectors and 2 aux inputs for music sources
- Input 1 also has an XLR XLR socket
- The input 1 has a signal detection circuit ('VOX') providing automatic priority operation
- Inputs 1 and 2 can access the priority through an external command
- The inputs 2 also has an RJ 45 port for quick connection of an RCF BM 3001 paging microphone (through CAT5 cable)
- The 2 mic-line inputs have a high-pass filter that are useful to improve speech intelligibility
- 2 Aux inputs with tone controls, selectable on the front panel
- A 'MUSIC ON HOLD' aux output allows to send the music to additional amplifiers, mixers, phone systems
- A 'PRE OUT' aux output to send the signal to additional amplifiers
- Digital Chime built-in generator
- The amplifier output is available either for low impedance loudspeakers (min. 4 Ω) or 100 - 70 V constant voltage line (for loudspeakers having 100 - 70 V transformers)
- Front panel LEDs indicate the device state (ON, PROT), priority circuit enabled (PRIOR) and the signal level / peak (SIG/PK)

AM 2080

AM 2160 AM 2320

p/n 121.35.058

p/n 121.35.059

INTEGRATED AMPLIFIERS



- 160/320W 4-input Mixer-Amplifier
- Input 1 on XLR
- VOX facility on input 1
- Priority activation through dry contact on all 4 inputs
- RJ45 connectors on input 2 and 3 for connection to BM3001 microphone
- Presence Control and per-channel High-Pass filters
- 2 Aux inputs with tone controls, selectable with two keys on the front panel
- Music On Hold and PRE outputs
- Digital Chime and Siren built-in generator
- 24V/0.5A priority relay output
- Status / Priority / Audio Level LED indications

REAR VIEW

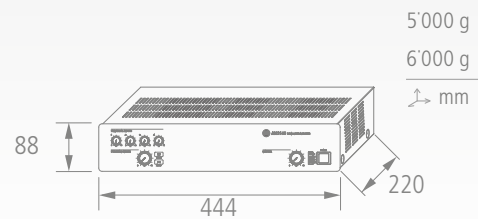

SPECIFICATIONS

AM 2160 - AM 2320

OUTPUT POWER	160 W (AM 2160) - 320 W (AM 2320)
FREQUENCY RESPONSE	50 Hz ÷ 18.000 kHz
DISTORTION (THD+N)	< 0.3% @ 1 kHz
SPEAKER OUTPUTS	100 V, 70 V, 4 Ω
AUXILIARY OUTPUTS	600 Ω, - 1 dBu (690 mV)
SIGNAL TO NOISE RATIO	> 60 dB (INPUTS 1-4); > 80 dB (AUX IN)
INPUT SENSITIVITY	(MIC) -58 dBu (1 mV); (MIC PHANTOM) -21 dBu (70 mV); (LINE) 0 dBu (775 mV); (AUX) -6 ÷ +13 dBu (0.39 ÷ 3.5 V)
INPUT IMPEDANCE	(MIC) 10 kΩ; (MIC PHANTOM) 5 kΩ; (LINE): 10 kΩ; (AUX): 20 kΩ
SUPPLY VOLTAGE	230 V / 115 (50 / 60 Hz) - INTERNAL SETTING
POWER CONSUMPTION	240 W (AM 2160) - 440 W (AM 2320)
INPUT CONNECTORS	1 x XLR, 2 x RJ 45, 4 x SCREW TERMINALS, 2 x DOUBLE RCA (AUX)
OUTPUT CONNECTORS	2 x RCA (MUSIC ON HOLD, PRE-OUT), SCREW TERMINALS FOR SPEAKERS

BM 3001

MICROPHONE CONSOLE

p/n 143.22.008



Dedicated microphone console with Cat5 connection cable and RJ45 connector.



UP 2161 UP 2321

POWER AMPLIFIERS

EASYLINE SOLUTIONS | p/n 121.35.060

| p/n 121.35.061



- Versatile amplifier for music and announcements
- Three different models with same features but different power: UP 2161 - 160 W; UP 2321 - 320 W
- Main input with selectable phantom power on removable connector XLR or RJ45 (for a quick connection with BM3001 through CAT5FTP cable)
- AUX input for audio sources (CD players, radios, etc.) through RCA connector
- Tone controllers and gain on AUX input
- Main input with priority option on the auxiliary one
- Main input with presence control and high-pass filter to enhance voice intelligibility
- Available output for low impedance speakers (4 Ohm min) or for constant voltage 100 - 70 V
- LED indicators on the front panel to monitor the amp status (ON, PROT, OVERLOAD) the selected priority (PRIOR) and signal level (SIG / PK)
- Rack mount kit for 2U amps included

REAR VIEW

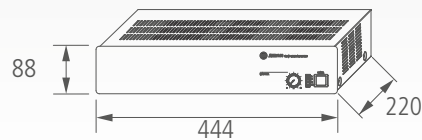

4'500 g
5'500 g
↕ mm

SPECIFICATIONS

UP 2161 - UP 2321

OUTPUT POWER	160 W (UP 2161) - 320 W (UP 2321)
FREQUENCY RESPONSE	50 Hz ÷ 18.000 kHz
DISTORTION (THD+N)	< 0.3% @ 1 kHz
SPEAKER OUTPUT	100 V, 70 V, 4 Ω
SIGNAL/NOISE RATIO	> 60 dB (INPUTS 1-4); > 80 dB (AUX IN)
INPUT SENSITIVITY	(MIC) -58 dBu (1 mV); (MIC PHANTOM) -21 dBu (70 mV); (LINE) 0 dBu (775 mV); (AUX) -6 ÷ +13 dBu (0.39 ÷ 3.5 V)
INPUT IMPEDANCE	(MIC) 10 kΩ; (MIC PHANTOM) 5 kΩ; (LINE): 10 kΩ; (AUX): 20 kΩ
POWER SUPPLY	230 V / 115 (50 / 60 Hz) - INTERNAL SETTING
ABSORBED POWER	240 W (UP 2161) - 440 W (UP 2321)
INPUT CONNECTORS	1 x XLR, 1 x RJ 45, 1 x SCREW TERMINALS, 1 x DOUBLE RCA (AUX)
OUTPUT CONNECTORS	SCREW TERMINALS

BM 3001

MICROPHONE CONSOLE

EASYLINE SOLUTIONS
| p/n 143.22.008

BM 3001 microphone console with CAT5 cable and RJ 45 connectors.



UP 2082
UP 2162
POWER AMPLIFIERS

p/n 121.35.066

p/n 121.35.065



- UP 2082 and UP 2162 are devices with 2 separated and independent amplifiers, each one with an 80 W (UP 2082) or 160 W (UP 2162) power.
- Each amplifier features 2 audio inputs to "line" level, one of these with priority function
- Each amplifier has its own volume and tone controls
- Light indicators for the system status (ON), protection (PROT), priority circuit activation (PRIOR) and peak/audio signal level (SIG/PK) of the corresponding amplifier
- Two outputs for each amplifier, available to low impedance (4 Ω) or constant voltage 100 – 70 V
- 19" rack mount kit

REAR VIEW

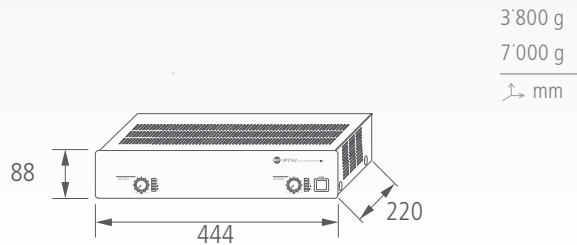

SPECIFICATIONS

UP 2082

UP 2162

OUTPUT POWERS	2 x 80 W	2 x 160 W
FREQUENCY RESPONSE	50 - 16.000 Hz (± 3 dB)	50 - 16.000 Hz (± 3 dB)
DISTORTION (THD+N)	< 0,3% @ 1 kHz	< 0,3% @ 1 kHz
SPEAKER OUTPUTS	100 V, 70 V, 4 Ω	100 V, 70 V, 4 Ω
AUXILIARY OUTPUTS	600 Ω, -1 dBu (690 mV)	600 Ω, -1 dBu (690 mV)
SIGNAL/NOISE RATIO	> 80 dB	> 80 dB
INPUT SENSITIVITY	IN 1: -12 dBu, IN 2: -32 ÷ -12 dBu	IN 1: -12 dBu, IN 2: -32 ÷ -12 dBu
INPUT IMPEDANCE	IN 1: 20 kΩ, IN 2: 20 kΩ (stereo: 10 kΩ)	IN 1: 20 kΩ, IN 2: 20 kΩ (stereo: 10 kΩ)
POWER SUPPLY	115-230V (internal setting) / 50-60 Hz	115-230V (internal setting) / 50-60 Hz
ABSORBED POWER	350 W	700 W
INPUT CONNECTORS	2 x SCREW TERMINALS	2 x SCREW TERMINALS
OUTPUT CONNECTORS	REMOVABLE SCREW TERMINALS	REMOVABLE SCREW TERMINALS

UP 8501 UP 8502

| p/n 121.35.070

| p/n 121.35.077

DIGITAL POWER AMPLIFIER



- Class D amplifier and double switching AC-DC power supply, transformer-less galvanic insulated speaker output
- Pro audio performance
- Selectable 70 – 100 V output per channel
- Double input per channel
- Active full protections on amplifier and power supply
Stand-by, priority and fault remote commands
Activity and status indicators
Volume knobs on front panel with disablement facility
Light-weight 1 U 19" rack enclosure

REAR VIEW

UP 8501

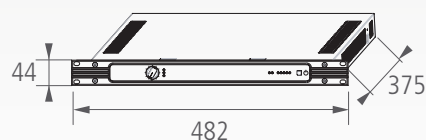

1'124 g
↕ mm

UP 8502

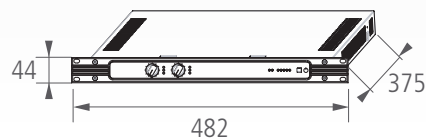

1'168 g
↕ mm

SPECIFICATIONS

	UP 8501	UP 8502
NO. CHANNELS X OUTPUT POWER (RMS)	1 X 500 W	2 X 250 W
FREQUENCY RESPONSE	40 Hz ÷ 16 kHz	
BAND-PASS FILTER (12 DB / OCT)	200 Hz ÷ 8 kHz	
THD AND NOISE (AT MAX. POWER)	MAX. 0.3%	
SIGNAL / NOISE RATIO (IEC-A)	86 DB	
INPUT 1 SENSITIVITY	0 dBu (775 mV, max. 7 V)	
INPUT 2 SENSITIVITY	0 ÷ -20 dBu (775 ÷ 78 mV, max. 7 V)	
IN TEST SENSITIVITY	0 dBu (775 mV)	
INPUT IMPEDANCE	10 kΩ	
MINIMUM LOAD IMPEDANCE OF EACH 70 V LINE	10 Ω	20 Ω
MINIMUM LOAD IMPEDANCE OF EACH 100 V LINE	20 Ω	40 Ω
OVER SIGNAL LIMITER	20 dB	
OPERATING VOLTAGE	Da rete: 115 – 230V c.a. ±10%, 50 – 60 Hz (internal voltage selector) Batteries: 48 V c.c. ±10%	
POWER CONSUMPTION, AC STAND-BY	3 W	
POWER CONSUMPTION, DISABLED AMP.	13 W	15 W
POWER CONSUMPTION, NO INPUT SIGNAL	25 W	36 W
POWER CONSUMPTION, MUSICAL SIGNAL	160 W	
POWER CONSUMPTION, MAX. OUTPUT POWER	650 W	
POWER CONSUMPTION, MAX. OVERLOAD	800 W	
OPERATING TEMPERATURE	0 ÷ 55 °C; Humidity: max 90%	
DIMENSIONS (W, H, D)	482 mm, 44 mm, 375 mm (1 rack unit 19")	
NET WEIGHT	5.1 KG	5.3 KG

UP 8504

DIGITAL POWER AMPLIFIER

| p/n 121.35.079



- Class D amplifier and double switching AC-DC power supply, transformer-less galvanic insulated speaker output
- Pro audio performance
- Selectable 70 – 100 V output per channel
- Double input per channel
- Active full protections on amplifier and power supply
- Stand-by, priority and fault remote commands
- Activity and status indicators
- Volume knobs on front panel with disablement facility
- Light-weight 1 U 19" rack enclosure

REAR VIEW

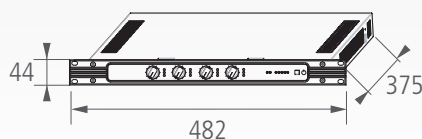

1'212 g
mm

SPECIFICATIONS

UP 8504

NO. CHANNELS X OUTPUT POWER (RMS)	4 X 125 W
FREQUENCY RESPONSE	40 HZ ÷ 16 kHz
BAND-PASS FILTER (12 DB / OCT)	200 HZ ÷ 8 kHz
THD AND NOISE (AT MAX. POWER)	MAX. 0.3%
SIGNAL / NOISE RATIO (IEC-A)	86 DB
INPUT 1 SENSITIVITY	0 dBu (775 mV, max. 7 V)
INPUT 2 SENSITIVITY	0 ÷ -20 dBu (775 ÷ 78 mV, max. 7 V)
IN TEST SENSITIVITY	0 dBu (775 mV)
INPUT IMPEDANCE	10 kΩ
MINIMUM LOAD IMPEDANCE OF EACH 70 V LINE	40 Ω
MINIMUM LOAD IMPEDANCE OF EACH 100 V LINE	80 Ω
OVER SIGNAL LIMITER	overload, short circuit, overheating
OPERATING VOLTAGE	Da rete: 115 – 230V c.a. ±10%, 50 – 60 Hz (internal voltage selector) Batteries: 48 V c.c. ±10%
POWER CONSUMPTION, AC STAND-BY	3 W
POWER CONSUMPTION, DISABLED AMP.	20 W
POWER CONSUMPTION, NO INPUT SIGNAL	50 W
POWER CONSUMPTION, MUSICAL SIGNAL	160 W
POWER CONSUMPTION, MAX. OUTPUT POWER	650 W
POWER CONSUMPTION, MAX. OVERLOAD	800 W
OPERATING TEMPERATURE	0 ÷ 55 °C; Humidity: max 90%
DIMENSIONS (W, H, D)	482 mm, 44 mm, 375 mm (1 rack unit 19")
NET WEIGHT	5.5 KG

UP 1121

INTEGRATED AMPLIFIER

p/n 121.35.083

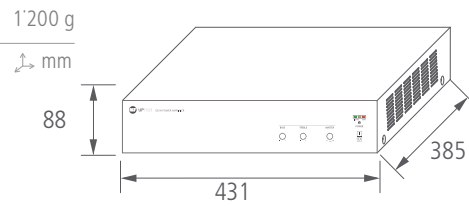

- 120 W power amplifier
- Single balanced 'line' level audio input (terminal strip)
- Amplifier output to loudspeakers, available as 100 / 70 V constant voltage line and Low impedance (min. 4 Ω)
- Input for the secondary 24 V dc power supply (batteries)
- MASTER volume control with screw
- BASS and TREBLE tone screw control (centre position is flat response)
- Main POWER switch
- LEDs indicating the audio signal level
- Main connector with fuse

SPECIFICATIONS

TYPE	STEREO AMPLIFIER
FREQUENCY RESPONSE	60 ÷ 15.000 Hz
POWER CONSUMPTION	120 W
ABSORBED POWER	120 W RMS
INPUT SENSITIVITY	LINE: 1 V (+ 2 dBu)
INPUT IMPEDANCE	10 KΩ (balanced)

UP 1121

TYPE	STEREO AMPLIFIER
FREQUENCY RESPONSE	60 ÷ 15.000 Hz
POWER CONSUMPTION	120 W
ABSORBED POWER	120 W RMS
INPUT SENSITIVITY	LINE: 1 V (+ 2 dBu)
INPUT IMPEDANCE	10 KΩ (balanced)

AM 1125

MIXER AMPLIFIER

p/n 121.35.082

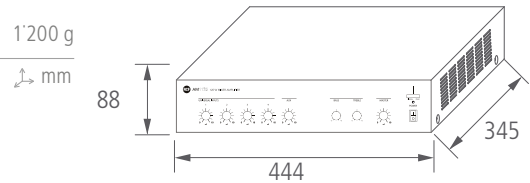

- 120W 4-inputs Mixer-Amplifier
- 4 XLR input
- VOX facility and Phantom power supply on input 1
- Audio input 3 also with dual RCA connector
- Aux input on dual RCA connector
- DUCKING Control to adjust the Aux in level
- Audio output (with RCA connector) that sends the same signal routed to the internal amplifier
- Audio input (with RCA connector) to connect an external device directly to the internal power amplifier
- AM 1125 Input for the secondary 24 V dc power supply (batteries)
- Amplifier output to loudspeakers, available as 100 / 70 V constant voltage line and Low impedance (min. 4 Ω)

SPECIFICATIONS

TYPE	STEREO AMPLIFIER
FREQUENCY RESPONSE	50 ÷ 15.000 Hz
POWER CONSUMPTION	240 W
ABSORBED POWER	120 W RMS
INPUT SENSITIVITY	MIC: 1.5 mV (- 54 dBu) dBu LINE & AUX: 200 mV (- 12 dBu) dBu
INPUT CONNECTORS	XLR or Dual RCA
OUTPUT CONNECTORS	Dual RCA

AM 1125

TYPE	STEREO AMPLIFIER
FREQUENCY RESPONSE	50 ÷ 15.000 Hz
POWER CONSUMPTION	240 W
ABSORBED POWER	120 W RMS
INPUT SENSITIVITY	MIC: 1.5 mV (- 54 dBu) dBu LINE & AUX: 200 mV (- 12 dBu) dBu
INPUT CONNECTORS	XLR or Dual RCA
OUTPUT CONNECTORS	Dual RCA

AM 6020

MOBILE AMPLIFIER

p/n 121.10.012

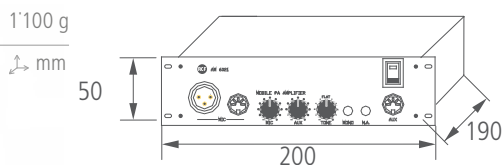

- 2 unbalanced AUX stereo inputs on DIN connector
- 1 balanced microphone input on DIN connector, 1 balanced microphone input on XLR connector
- Circuit for automatic attenuation of music in the presence of announcements
- One-tone signal generator 600 Hz (siren)
- Protection against overload and short circuits
- Power supply 12 Vdc or 24 Vdc selectable

SPECIFICATIONS

TYPE	STEREO AMPLIFIER
FREQUENCY RESPONSE	150÷6.000 Hz (mic) 20÷15.000 Hz (aux)
CONSUMPTION	80 W (24 V cc) - 40 W (12 V cc)
NOMINAL POWER	20+20 W (24 V cc) - 10+10 W (12 V cc)
INPUT SENSITIVITY	50 mV ÷ 5 V RMS
CONNECTORS	DIN o XLR / 0,7 mV – 2 KOhm (mic), e DIN (aux) / 150 mV – 22 KOhm

AM 6020

TYPE	STEREO AMPLIFIER
FREQUENCY RESPONSE	150÷6.000 Hz (mic) 20÷15.000 Hz (aux)
CONSUMPTION	80 W (24 V cc) - 40 W (12 V cc)
NOMINAL POWER	20+20 W (24 V cc) - 10+10 W (12 V cc)
INPUT SENSITIVITY	50 mV ÷ 5 V RMS
CONNECTORS	DIN o XLR / 0,7 mV – 2 KOhm (mic), e DIN (aux) / 150 mV – 22 KOhm

PR 4092

9 INPUTS, 2 OUTPUTS
PREAMPLIFIER

p/n 121.35.032

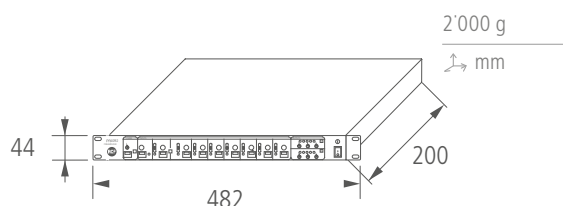

- Preamplifier/mixer 9 inputs - 2 outputs
- 9 balanced XLR inputs
- 8 inputs have MIC/LINE sensitivity
- Switchable PHANTOM 12 V power supply and HIGH-PASS filters on the microphone inputs
- Each input has an OUTPUT SELECTOR
- SIGNAL presence indicator on each input
- 2 levels of PRIORITY:
 - input 1 by VOX or by contact on removable connector
 - inputs 2 and 3 by VOX

- 4 of the LINE inputs are available on RCA stereo connectors
- Built-in three-tone chime generator with contact on removable Euro-block connector
- 2 balanced XLR outputs
- Tone controls (Treble and Bass) on each output
- LED level measurement on the two outputs
- RECORD OUTPUT on RCA connector (pre-master)
- 19" rack mount 1U

SPECIFICATIONS

AUDIO OUTPUT LEVEL	MASTER A,B: +4 dBu (1,23 V); REC: 0 dBu (775 mV)
FREQUENCY RESPONSE	20 ÷ 20.000 Hz
DISTORTION (THD+N)	< 0,5% (MIC); < 0,3% (LINE)
TONE CONTROLS	BASSI: 100 Hz ± 10 dB; ALTI: 10 kHz ± 10 dB
SIGNAL TO NOISE RATIO	> 60 dB (MIC)
INPUT SENSITIVITY	MIC: - 50 dBu (2,45 mV); LINE: - 10 dBu (245 mV)
INPUT IMPEDANCE	MIC (XLR) e LINE (XLR): 5 kΩ BILANCIATO; LINE (RCA): 10 kΩ BILANCIATO
OUTPUT IMPEDANCE	MASTER 200 kΩ BILANCIATO; REC: 2,2 kΩ SBILANCIATO
SUPPLY VOLTAGE	220÷240 V / 110÷120 V (50 / 60 Hz) - 24 VCC
POWER CONSUMPTION	450 W
INPUT CONNECTORS	9 x XLR, 4 x RCA (L&R)
OUTPUT CONNECTORS	2 x XLR, 2 x RCA

PR 4092

AUDIO OUTPUT LEVEL	MASTER A,B: +4 dBu (1,23 V); REC: 0 dBu (775 mV)
FREQUENCY RESPONSE	20 ÷ 20.000 Hz
DISTORTION (THD+N)	< 0,5% (MIC); < 0,3% (LINE)
TONE CONTROLS	BASSI: 100 Hz ± 10 dB; ALTI: 10 kHz ± 10 dB
SIGNAL TO NOISE RATIO	> 60 dB (MIC)
INPUT SENSITIVITY	MIC: - 50 dBu (2,45 mV); LINE: - 10 dBu (245 mV)
INPUT IMPEDANCE	MIC (XLR) e LINE (XLR): 5 kΩ BILANCIATO; LINE (RCA): 10 kΩ BILANCIATO
OUTPUT IMPEDANCE	MASTER 200 kΩ BILANCIATO; REC: 2,2 kΩ SBILANCIATO
SUPPLY VOLTAGE	220÷240 V / 110÷120 V (50 / 60 Hz) - 24 VCC
POWER CONSUMPTION	450 W
INPUT CONNECTORS	9 x XLR, 4 x RCA (L&R)
OUTPUT CONNECTORS	2 x XLR, 2 x RCA

FLUSH MOUNTED AND WALL SPEAKERS

The best solutions for wall or flush installations in false ceiling or panels.



MODEL	PL 40	PL 50	PL 60	PL 6X	PL 8X	PL 60 FD
TYPE	Ceiling speaker	Ceiling speaker	Ceiling speaker	Ceiling speaker	Ceiling speaker	Ceiling speaker
INSTALLATION	Flush mounted	Flush mounted	Flush mounted	Flush mounted	Flush mounted	Flush mounted
COLOUR	White	White	White	White	White	White
SPEAKER	3.5"	6"	6" dual-cone	6" + 1"	8" + 1"	6" dual-cone
POWER NOM. / PROGRAM	8 W RMS / 16 W	3 W RMS– 6 W	6 W RMS / 12 W	12 W RMS / 24 W	20 W RMS / 40 W	6 W RMS / 10 W
INPUT	100 V, 70 V	100 V	100 V, 70 V	100 V, 70 V	100 V, 70 V	100 V, 70 V
FREQUENCY RESPONSE	90 ÷ 20.000 Hz	100 Hz ÷ 20 kHz	110 ÷ 20.000 Hz	70 ÷ 20.000 Hz	60 ÷ 20.000 Hz	150 ÷ 15.000 Hz
MAX. SOUND PRESSURE	100 dB	98 dB	102 dB	106 dB	109 dB	105 dB
ANGLE OF COVERAGE	120°	150°	150°	100°	80°	150°
PROTECTION	IP 44	IP 40	IP 40	IP 44	IP 44	IP 40



MODEL	PL 70 EN	PL 68 EN	HS 1026	PLF 30	BS 8	BS 2620	BS 5EN
TYPE	Ceiling speaker	Ceiling speaker	Ceiling speaker	Ceiling speaker	Spherical	Spherical	Suspension
INSTALLATION	Flush mounted	Flush mounted	Flush mounted	Flush mounted	Suspended	Suspended	Suspended
COLOUR	White	White	White/Gold/Chrome	White (paintable)	White	White	Bianco
SPEAKER	6" dual-cone	6" dual-cone	2,5"	3"	8"	6" dual-cone	5" coaxial
POWER NOM. / PROGRAM	6 W RMS / 12 W	6 W RMS / 12 W	6 W RMS / 12 W	12 – 6 W	20 W RMS / 40 W	20 W RMS / 40 W	20-10-5-2,5 / 40 W
INPUT	100 V, 70 V	100 V, 70 V	100 V, 70 V	100 V	100 V	100 V	100 V
FREQUENCY RESPONSE	120 ÷ 14.000 Hz	130 ÷ 14.000 Hz	220 ÷ 17.000 Hz	150 Hz ÷ 7 kHz	160 ÷ 12.500 Hz	20 ÷ 20.000 Hz	150 ÷ 18.000 Hz
MAX. SOUND PRESSURE	109 dB	102 dB	102 dB	99 dB	106 dB	106 dB	99 dB (20 W, 1 m), 87 dB (20 W, 4 m) dB
ANGLE OF COVERAGE	150°	140°	170°	170°	140°	150°	160°
PROTECTION	IP 40	IP 40	IP 40	IP 40	IP 40	IP 55	IP 65



MODEL	DM 41	DM 61	DU50 EN	DU 100X	WS 620-XT
TYPE	Compact two-way	Compact two-way	Universal	Universal	Universal two-way
INSTALLATION	Wall	Wall	Wall or flush mounted	Wall or flush mounted	Flush-mounted
COLOUR	White Ivory	White Ivory	White	White	White
SPEAKER	3.5" + 1"	6" + 1"	4,5"	4" + 1"	6" + 1"
POWER NOM. / PROGRAM	15 W RMS / 30 W	25 W RMS / 50 W	6 W RMS / 12 W	10 W RMS / 20 W	12 W RMS / 24 W
INPUT	100 V, 70 V	100 V, 70 V	100 V, 70 V	100 V, 70 V, 25 V	100 V, 70 V, 4 Ω
FREQUENCY RESPONSE	100 ÷ 20.000 Hz	70 ÷ 20.000 Hz	200 ÷ 12.000 Hz	100 ÷ 18.000 Hz	70 ÷ 20.000 Hz
MAX. SOUND PRESSURE	102 dB	106 dB	102 dB	103 dB	105 dB
ANGLE OF COVERAGE	180° (Horiz) 170° (Ver)	120° (Horiz) 140° (Ver)	150°	100° (Horiz) 140° (Ver)	120°
PROTECTION	IP 55	IP 55	IP 40	IP 40	IP 55



MODEL	DU 31	DU 31 AT	ELISA 50	DMW 20A
TYPE	Universal two-way	Universal two-way	Universal	2 way active
INSTALLATION	Wall or Flush-mounted	Wall or Flush-mounted	Flush-mounted	Wall or Flush-mounted
COLOUR	White Ivory	White Ivory	White	White
SPEAKER	3.5" + 0.85"	3.5" + 0.85"	3.5"	3" full-range
POWER NOM. / PROGRAM	8 - 4 - 2 W (100 V) - 8 W (25 V)	8 - 4 - 2 - 1 - 0,5W(100V) - 8W(25V)	6 W RMS / 12 W	20 W RMS
INPUT	100 V, 70 V, 25 V	100 V, 70 V, 25 V	100 V, 70 V, 25 V, 4 Ω	RCA AND 6.3 MM JACK BALANCED
FREQUENCY RESPONSE	100 ÷ 17.000 Hz	100 ÷ 17.000 Hz	120 ÷ 16.000 Hz	130 Hz ÷ 20 kHz
MAX. SOUND PRESSURE	91 dB	91 dB	99 dB	98 dB
ANGLE OF COVERAGE	160°	160°	160°	-
PROTECTION	IP 40	IP 40	IP 40	IP 40

HS 1026W

SPOTLIGHT CEILING SPEAKER

p/n 131.10.062

- For paging and background music
- High-pass filter for use with optional subwoofer
- Low impedance (8Ω) or 100V
- Built-in multi-tapped transformer for 100/70V constant voltage connection
- Ease of installation in standard holes used for lightspots

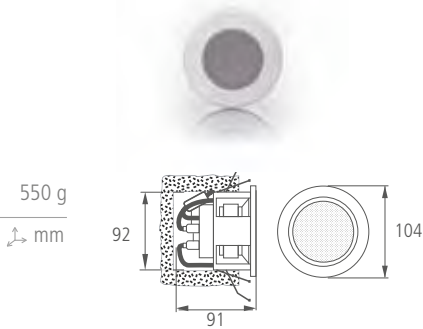

SPECIFICATIONS

HS 1026 W

POWER	6 - 3 W (100 V)
CONSTANT VOLTAGE	100 V, 70 V
FREQUENCY RESPONSE	220 ÷ 17.000 Hz (± 3 dB)
SENSITIVITY (1 m / 1 W)	89 dB
MAXIMUM SOUND PRESSURE	102 dB (1 m / POWER MAX)
ANGLE OF COVERAGE	170°

PLF 30

PAINTABLE FLUSH MOUNTING CEILING SPEAKER

p/n 131.33.061

- Particularly suitable for business music applications
- Extra-wide dispersion over 160°
- 3" wide-range transducer with flat diaphragm
- Sound Pressure Level: 83 dB @ 1W/1m | For 100/70V constant voltage connection
- Built-in multi-tapped transformer | Body in self-extinguishing plastic
- Front paintable flat cone in white, Clips or Spring-type mounting systems provided

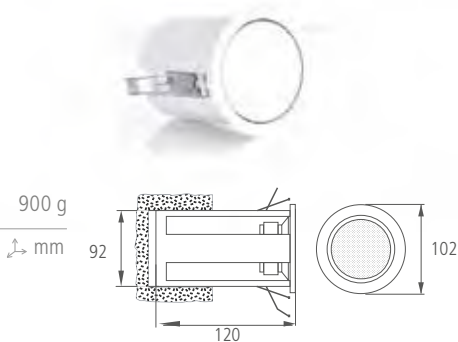

SPECIFICATIONS

PLF 30

POWER	12 - 6 W
CONSTANT VOLTAGE	100 V
FREQUENCY RESPONSE	150 ÷ 7.000 Hz (± 3 dB)
SENSITIVITY (1 m / 1 W)	88 dB
MAXIMUM SOUND PRESSURE	99 dB (1 m / POWER MAX)
ANGLE OF COVERAGE	170°

WS 620XT

TWO-WAY WEATHER RESISTANT
FLUSH MOUNTING SPEAKER

p/n 131.33.044

- Weather resistant splashproof speaker
- 6" woofer with coaxial tweeter
- Two way speaker system with coaxial tweeter, recommended for hi level speech and background-music reproduction
- Body and grille in plastic RAL 9016 White | IP 55 protection

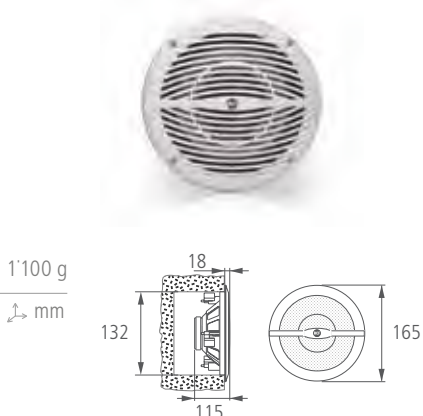

SPECIFICATIONS

WS 620XT

POWER	12 - 6 - 3 W (100 V)
CONSTANT VOLTAGE	100 V, 70 V
FREQUENCY RESPONSE	70 ÷ 20.000 Hz (± 3 dB)
SENSITIVITY (1 m / 1 W)	91 dB
MAXIMUM SOUND PRESSURE	105 dB (1 m / POWER MAX)
ANGLE OF COVERAGE	120°

PL 40
CEILING SPEAKER

p/n 131.33.045

- For speech and background-music reproduction
- Low impedance (8Ω) or 100V
- 3.5" full range speaker
- Three hooks mounting system (no screws or other attachment elements)
- Body in self-extinguishing (UL 94V-0) plastic and front metal grille RAL 9003 White
- IP 44 protection

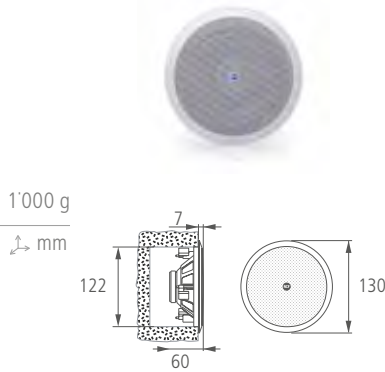

SPECIFICATIONS

PL 40

POWER	8 - 6 - 4 - 2 W (100 V)
CONSTANT VOLTAGE	100 V, 70 V
FREQUENCY RESPONSE	90 ÷ 20.000 Hz (± 3 dB)
SENSITIVITY (1 m / 1 W)	88 dB
MAXIMUM SOUND PRESSURE	100 dB (1 m / POWER MAX)
ANGLE OF COVERAGE	120°

PL 50
FULL RANGE FLUSH
MOUNTING CEILING SPEAKER

p/n 131.33.060 (only available in 12 pieces per package)

- Suitable for paging and background music applications
- 6" wide band loudspeaker
- Sound pressure level at music power: 91 dB @ 1W/1m
- Built-in multi-tap line transformer, 100V and 70V constant voltage connection
- Body in self-extinguishing plastic, white colour
- Spring-type mounting system

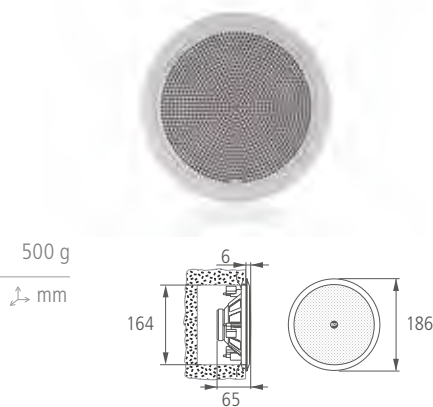

SPECIFICATIONS

PL 50

POWER	6 - 3 W
CONSTANT VOLTAGE	100 V
FREQUENCY RESPONSE	100 Hz ÷ 20 kHz (± 3 dB)
SENSITIVITY (1 m / 1 W)	90 dB
MAXIMUM SOUND PRESSURE	98 dB (1 m / POWER MAX)
ANGLE OF COVERAGE	150°

PL 60
HIGH EFFICIENCY CEILING SPEAKER

p/n 131.10.214

- For paging and background music
- 6" dual cone wide band loudspeaker
- Sound pressure level at music power: 102 dB/1 m
- Low impedance (4Ω) or 100V
- Built-in multi-tapped transformer for 100/70V constant voltage connection
- Body in self-extinguishing plastic UL-94-V0 and front metal grille RAL 9010 White
- Optional accessory: A 1360 base for surface mount installation (p/n13320107)

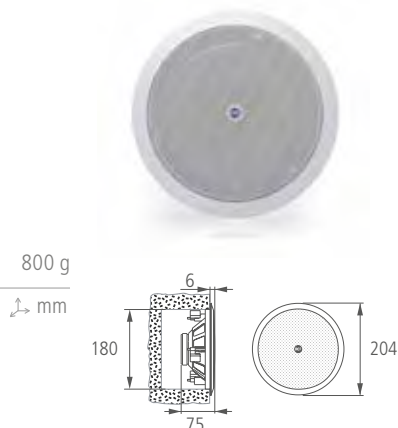

SPECIFICATIONS

PL 60

POWER	6 - 3 W (100 V)
CONSTANT VOLTAGE	100 V, 70 V
FREQUENCY RESPONSE	110 ÷ 20.000 Hz (± 3 dB)
SENSITIVITY (1 m / 1 W)	91 dB
MAXIMUM SOUND PRESSURE	102 dB (1 m / POWER MAX)
ANGLE OF COVERAGE	150°

EN
60849

PL 60FD

CEILING SPEAKER WITH FIRE DOME



2'800 g

mm

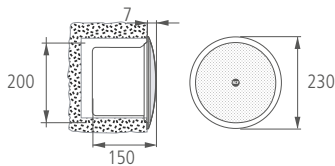

p/n 131.33.059

- Especially suitable for alarm/evac applications
- 6" dual cone wide band loudspeaker
- Sound pressure level at music power: 105 dB/1 m
- Low impedance (8Ω) or 100V
- Built-in multi-tapped transformer for 100/70V constant voltage connection
- Metal back cover, RAL 3020 red
- Ceramic termination blocks, thermal fuse, fire resistant cable
- Front metal grille RAL 9010 White

SPECIFICATIONS

PL 60FD

POWER	6 - 3 - 1,5 W (100 V)
CONSTANT VOLTAGE	100 V, 70 V
FREQUENCY RESPONSE	150 ÷ 15.000 Hz (± 3 dB)
SENSITIVITY (1 m / 1 W)	94 dB
MAXIMUM SOUND PRESSURE	105 dB (1 m / POTENZA MAX)
ANGLE OF COVERAGE	150°

EN
54
CERTIFIED

PL 70EN

CEILING SPEAKER WITH FIRE DOME



2'000 g

mm

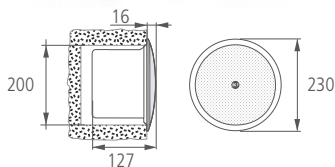

p/n 131.33.065

- Speaker for transmitting voice alarm messages with high intelligibility and background music
- 6" diameter dual cone wide band loudspeaker
- Low impedance (8Ω) or 100V
- Steel protection Fire Dome, terminal strip in ceramic material for connecting flameproof input and output cables, thermal fuse, suitable internal wiring
- Conforms to EN 54-24 regulations
- Structure, front grille, and protection cap in steel, RAL 9003 White

SPECIFICATIONS

PL 70EN

POWER	6 - 3 - 1.5 W (100 V)
CONSTANT VOLTAGE	100 V, 70 V
FREQUENCY RESPONSE	120 ÷ 14.000 Hz (± 3 dB)
SENSITIVITY (1 m / 1 W)	95 dB
MAXIMUM SOUND PRESSURE	109 dB (1 m / POWER MAX)
ANGLE OF COVERAGE	150°

EN
54
CERTIFIED

PL 68 EN

CEILING SPEAKER FIRE DOME



1'300 g

mm

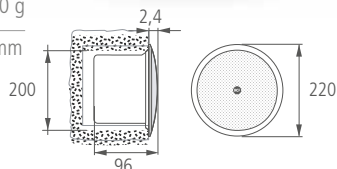

p/n 131.33.082

- Flameproof steel bottom designed and steel protection grille
- Speaker for transmitting alarm voice messages with high intelligibility and background music
- 6" diameter dual cone wide band loudspeaker
- Steel protection Fire Dome, terminal strip in ceramic material for connecting flameproof input and output cables, thermal fuse, suitable internal wiring
- Conforms to EN 54-24 regulations
- Structure, front grille, and protection cap in steel, RAL 9003 White

SPECIFICATIONS

PL 68 EN

SELECTABLE POWER	6 - 3 - 1,5 W (100 V)
CONSTANT VOLTAGE	100 V, 70 V
FREQUENCY RESPONSE	130 ÷ 20.000 Hz (± 3 dB)
SENSITIVITY (1 m / 1 W)	94 dB
MAX SPL	105 dB (1 m / POTENZA MAX)
COVERAGE ANGLE	140°

PL 6X

COAXIAL CEILING SPEAKER

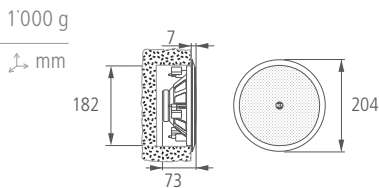

p/n 131.33.042

- Two way speaker system with dome tweeter recommended for speech and background-music reproduction
- 6" woofer with coaxial tweeter
- Low impedance (8Ω) or 100V
- Built-in multi-tapped transformer for 100/70V constant voltage connection
- Three hooks mounting system (no screws or other attachment elements)
- Body in self-extinguishing (UL 94V-0) plastic and front metal grille RAL 9003 White

SPECIFICATIONS

PL 6X

POWER	12 - 6 - 3 W (100 V)
CONSTANT VOLTAGE	100 V, 70 V
FREQUENCY RESPONSE	70 ÷ 20.000 Hz (± 3 dB)
SENSITIVITY (1 m / 1 W)	92 dB
MAXIMUM SOUND PRESSURE	106 dB (1 m / POWER MAX)
ANGLE OF COVERAGE	100°

PL 8X

COAXIAL CEILING SPEAKER

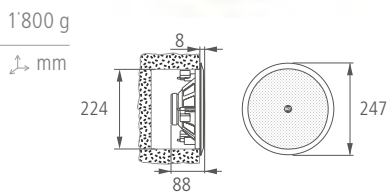

p/n 131.33.043

- Two way speaker system with dome tweeter for hi level speech and background-music
- 8" woofer with coaxial tweeter | Low impedance (8Ω) or 100V
- Built-in multi-tapped transformer for 100/70V constant voltage connection
- Body in self-extinguishing plastic (UL 94V-0) and front metal grille RAL 9003 White

SPECIFICATIONS

PL 8X

POWER	20 - 10 - 5 - 2.5 W (100 V)
CONSTANT VOLTAGE	100 V, 70 V
FREQUENCY RESPONSE	60 ÷ 20.000 Hz (± 3 dB)
SENSITIVITY (1 m / 1 W)	93 dB
MAXIMUM SOUND PRESSURE	109 dB (1 m / POWER MAX)
ANGLE OF COVERAGE	80°

AC 50B

FLUSH MOUNT BOX



p/n 133.60.038

- Flush mount box for E.I.S.A. 50 speaker
- Dimensions. 152x97x70 mm

AC 1503

CERAMIC TERMINAL WITH THERMAL FUSE ACCESSORY



p/n 133.60.112

- Accessory with ceramic terminal and a thermal fuse to connect a loudspeaker in sound systems for emergency purposes

DU 31

FLUSH MOUNT WALL SPEAKER



600 g

↕ mm

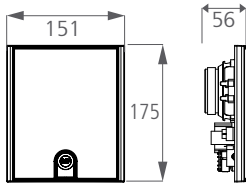

p/n 130.00.204

- For paging and background music for several type of installation
- 2 way wall speaker with flexible design with wide band 3,5" woofer and 1" tweeter
- Includes a transformer for the connection to (100 - 70 - 25 V) constant voltage lines
- Power selector 8 W, 4 W, 2W at 100 V and a 25 V (8W) socket
- Universal wall mounting on standard European flush mounting boxes.
- Body in plastic, RAL 9002 White Ivory

SPECIFICATIONS

DU 31

POWER	8 - 4 - 2 W (100 V) - 8 W (25 V)
CONSTANT VOLTAGE	100 V, 70 V, 25 V
FREQUENCY RESPONSE	100 - 17.000 Hz (± 3 dB)
SENSITIVITY (1 m / 1 W)	82 dB
MAXIMUM SOUND PRESSURE	91 dB (1 m / POWER MAX)
ANGLE OF COVERAGE	160°

DU 31AT

FLUSH MOUNT WALL SPEAKER
WITH POWER SELECTOR



600 g

↕ mm

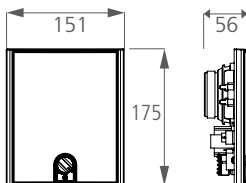

p/n 130.00.220

- For paging and background music for several type of installation
- 2 way wall speaker with flexible design with wide band 3,5" woofer and 1" tweeter
- Wattage taps (8 W, 4 W, 2W, 1W, 0,5W at 100 V) is selectable by means of a Rotary switch, accessible from the front panel
- Includes a transformer for the connection to (100 - 70 - 25 V) constant voltage lines and a 25 V socket makes it possible to connect multiple speakers in parallel to a constant impedance line
- Universal mounting in wall on the standard European flush mounting box (like Gewiss GW 48005 dimension 160(L) x 130(H) x 70(P) or B-Ticino 16205 - 170(L) x 145(H) x 70(P))
- Body in plastic, RAL 9002 White Ivory

SPECIFICATIONS

DU 31AT

POWER	8 - 4 - 2 - 1 - 0,5 W (100 V) - 8 W (25 V)
CONSTANT VOLTAGE	100 V, 70 V, 25 V
FREQUENCY RESPONSE	100 - 17.000 Hz (± 3 dB)
SENSITIVITY (1 m / 1 W)	82 dB
MAXIMUM SOUND PRESSURE	91 dB (1 m / POWER MAX)
ANGLE OF COVERAGE	160°

A1331

SURFACE MOUNT FOR
DU 31 / DU 31AT



pn 133.60.123

- Quickly and easily installed on any flat surface
- Body in plastic, RAL 9002 White Ivory



DU 31AT Table mounting support with tilt 15°



DU31 and A1331 wall mounting support with tilt 0°



DU31 and A1331 wall mounting support with tilt 15°



DU31 and A1331 flag mount support unidirectional



2 x DU31 and 2 x A1331 flag mount support bi-directional

DU 100X

COAXIAL SPEAKER

EASYLINE SOLUTIONS

p/n 130.00.105

- Ideal for paging and background music, wall or ceiling installation
- Dual-cone extended range loudspeaker, 4" diameter
- Plastic body with shock-proof metal grid
- Built-in multi-tapped transformer for 100/70V constant voltage connection
- Body in ABS and metal grille RAL 9003 White

1'100 g

↕ mm

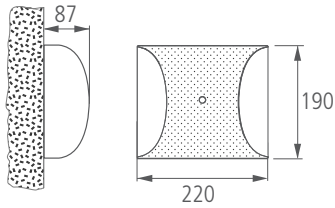

SPECIFICATIONS	DU 100X
POWER	10 - 5 - 2.5 - 1.25 - 0.75 W (100 V)
CONSTANT VOLTAGE	100 V, 70 V, 25 V
FREQUENCY RESPONSE	100 ÷ 18.000 Hz (± 3 dB)
SENSITIVITY (1 m / 1 W)	93 dB
MAXIMUM SOUND PRESSURE	103 dB (1 m / POWER MAX)
ANGLE OF COVERAGE	100° (HORIZ.); 140° (VERT.)

DU 50EN

UNIVERSAL STEEL SPEAKER



p/n 131.33.064

- Speaker designed for transmitting alarm messages with high intelligibility, and background music
- Wide-band dual cone loudspeaker, diameter 5"
- Extra-thick steel housing, terminal strip for connections made of ceramic material for flameproof input and output cables, thermal fuse, suitable internal wiring
- In compliance with norm EN 54-24
- Colour: RAL 9010 White

1'100 g

↕ mm

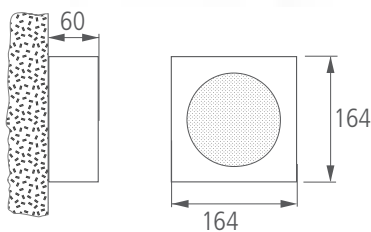

SPECIFICATIONS	DU 50EN
POWER	6-3-1,5-0,75 W (100 V)
CONSTANT VOLTAGE	100 V, 70 V
FREQUENCY RESPONSE	200 ÷ 12.000 Hz (± 3 dB)
SENSITIVITY (1 m / 1 W)	91 dB
MAXIMUM SOUND PRESSURE	102 dB (1 m / POTENZA MAX)
ANGLE OF COVERAGE	150°

E.LI.S.A. 50

COMPACT HI-DEFINITION FLUSH MOUNT WALL SPEAKER

p/n 131.10.071

- For high quality paging and background music
- Music power/RMS: 12/6W (20/10W in use without transformer, 4Ω)
- 3.5" extended range speaker with central equaliser, carbon fibre cone
- Equipped with multi-tapped transformer for 100/70/25V constant voltage connection
- Flush mount box with soundproof material included
- Front frame in ABS and metal grille RAL 9010 White

900 g

↕ mm

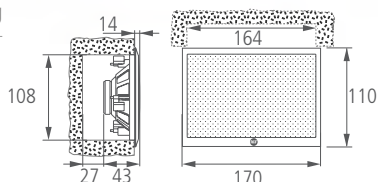

SPECIFICATIONS	E.LI.S.A. 50
POWER	6-3-1 W (100 V)
CONSTANT VOLTAGE	100 V, 70 V, 25 V, 4 Ω
FREQUENCY RESPONSE	120 ÷ 16.000 Hz (± 3 dB)
SENSITIVITY (1 m / 1 W)	88 dB
MAXIMUM SOUND PRESSURE	99 dB (1 m / POWER MAX)
ANGLE OF COVERAGE	160°

DM 41 DM 41-B Black

COMPACT TWO-WAY SPEAKER



p/n 130.00.049

p/n 130.00.387

- 3.5" woofer with mylar dome 1" tweeter
- Built-in multitap transformer for constant voltage system
- Body in self-extinguishing composite material
- IP55 protection, suitable for outdoor use
- Adjustable mounting accessory included

SPECIFICATIONS

SPECIFICATIONS	DM 41
POWER	15 - 10 - 5 - 2.5 W (100 V) SELEZ.
CONSTANT VOLTAGE	100 V, 70 V
FREQUENCY RESPONSE	100 ÷ 20.000 Hz (± 3 dB)
SENSITIVITY (1 m / 1 W)	87 dB
MAXIMUM SOUND PRESSURE	102 dB (1 m / POWER MAX)
ANGLE OF COVERAGE	180° (HORIZ.); 170° (VERT.)

DM 61

COMPACT TWO-WAY SPEAKER



p/n 130.00.050

- Woofer 6" with mylar dome tweeter
- Built-in multitap transformer for constant voltage system
- Body in self-extinguishing composite material
- IP55 protection, suitable for outdoor use
- Adjustable mounting accessory included

SPECIFICATIONS

SPECIFICATIONS	DM 61
POWER	25 - 15 - 10 - 5 W (100 V)
CONSTANT VOLTAGE	100 V, 70 V
FREQUENCY RESPONSE	100 ÷ 20.000 Hz (± 3 dB)
SENSITIVITY (1 m / 1 W)	89 dB
MAXIMUM SOUND PRESSURE	106 dB (1 m / POWER MAX)
ANGLE OF COVERAGE	120° (HORIZ.); 140° (VERT.)

DMW 20A

ACTIVE SPEAKER CABINET



p/n 130.00.265

- Compact, lightweight perfect for multimedia application
- High quality reference sound
- 20 watts built-in stereo power amplifier
- AC power input with switch ON/OFF
- Two-way speaker design
- Volume control knob on the rear panel
- Wall or ceiling mount with mounting brackets included
- Colour RAL 9010

SPECIFICATIONS

SPECIFICATIONS	DMW 20A
POWER RATING	20 W
SPEAKER	3" PAPER CONE, 0.8" VOICE COIL DIAMETER
MAX SPL	98 DB (@ 20 W)
POWER SUPPLY	220÷240 V / 50 HZ
INPUT CONNECTORS	RCA AND 6.3 MM JACK BALANCED
OUTPUT-LINK CONNECTORS	6.3 MM JACK BALANCED



BS 5EN

EN54-24 COMPLIANT SUSPENDED SOUND PROJECTOR

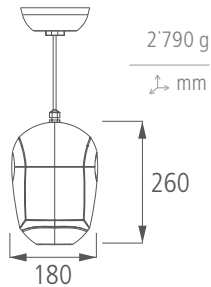

p/n 131.33.078

- 5" coaxial speaker for alarm voice messages broadcasting and high quality background music.
- ABS cabinet with steel mesh grille
- It can be installed both indoors and outdoors (IP 65 protection grade)
- Equipped with transformer for 100 V (/ 70 V) constant voltage lines
- Internal power setting
- Ceramic screw terminal for connection
- Internal thermal fuse
- 5 meters cable

SPECIFICATIONS

BS 5-EN

SELECTABLE POWER	20 - 10 - 5 - 2,5 W (100 V)
CONSTANT VOLTAGE	100 V, 70 V
FREQUENCY RESPONSE	150 ÷ 18.000 Hz
SENSITIVITY	86 dB (1 W, 1 m), 74 dB (1 W, 4m) dB
MASX SPL	99 dB (20 W, 1 m), 87 dB (20 W, 4 m) dB
COVERAGE ANGLE	160° Orizz. - 160° Vert.

BS 8

PENDENT BALL SPEAKER

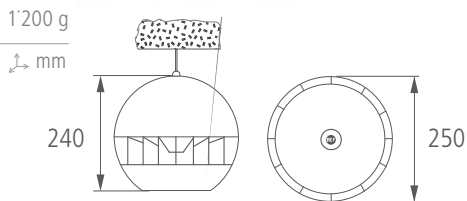

p/n 131.33.054

- Pendent speaker
- For paging and background music
- 8" diameter dual cone wide band speaker
- Plastic body - White RAL 9010
- Built-in transformer for 100V constant voltage connection
- 5-metre suspension and connection cable included

SPECIFICATIONS

BS 8

POWER	20-10-5 W (100 V)
CONSTANT VOLTAGE	100 V
FREQUENCY RESPONSE	160 ÷ 12.500 Hz (± 3 dB)
SENSITIVITY (1 m / 1 W)	93 dB
MAXIMUM SOUND PRESSURE	106 dB (1 m / POWER MAX)
ANGLE OF COVERAGE	360° (HORIZ.); 140° (VERT.)

BS 2620

HIGH PERFORMANCE PENDENT BALL SPEAKER

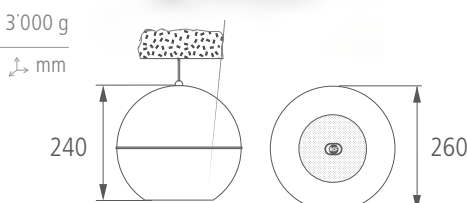

p/n131.10.006

- Pendent speaker
- For paging and background music
- 6" diameter dual cone wide band speaker
- 5-metre suspension and connection cable included
- Weather-resistant construction (IP55) for use both indoors and outdoors
- Body in self-extinguishing plastic UL94VO, UV ray protected, RAL 9010 White

SPECIFICATIONS

BS 2620

POWER	20-15-10-5-2.5 W (100 V)
CONSTANT VOLTAGE	100 V
FREQUENCY RESPONSE	50 ÷ 20.000 Hz (± 3 dB)
SENSITIVITY (1 m / 1 W)	93 dB
MAXIMUM SOUND PRESSURE	106 dB (1 m / POWER MAX)
ANGLE OF COVERAGE	360° (HORIZ.); 150° (VERT.)

SOUND PROJECTORS, MONITORS AND COLUMN SPEAKERS

Maximum speech intelligibility
for every public ambience and for any
kind of application.



MODEL	DP 4	BD 42	DP 2X/1	DP1420EN	BD 2412EN	DP 5EN	BD 5EN
TYPE	Projector	Projector Bidirectional	Projector two-way	Proiettore Allum.	Proiettore Bidirez.	Proiettore	Proiettore Bidirez.
INSTALLATION	Wall o Flush Mounted	Wall o Flush Mounted	Wall o Flush Mounted	Wall o Flush Mounted	Wall o Flush Mounted	Wall o Flush Mounted	Wall o Flush Mounted
COLOUR	Grey	Grey	White	Grey	Grey	Grey	White
SPEAKER	5"	2 x 5"	5" + 1"	5"	2 x 5"	5"	2 x 5"
POWER NOM./PROGRAM	10 W RMS / 20 W	12 W RMS / 24 W	4 W RMS / 8 W	20 W RMS / 40 W	20 W RMS / 40 W	20 W RMS / 40 W	20 W RMS / 40 W
INPUT	100 V	100 V	100 V, 4 Ω	100 V, 70 V,	100 V, 70 V,	100 V, 70 V,	100 V, 70 V,
FREQUENCY RESPONSE	180 ÷ 16.000 Hz	180 ÷ 16.000 Hz	150 ÷ 18.000 Hz	150 ÷ 20.000 Hz	130 ÷ 20.000 Hz	80 ÷ 20.000 Hz	150 ÷ 18.000 Hz
MAX. SOUND PRESSURE	101 dB	102 dB	102 dB	104 dB	102 dB	101 dB	99 dB
ANGLE OF COVERAGE	130°	130°*	110°	160°	130°*	160°*	160°*
PROTECTION	IP 55	IP 55	IP40	IP 66	IP 66	IP 65	IP 65

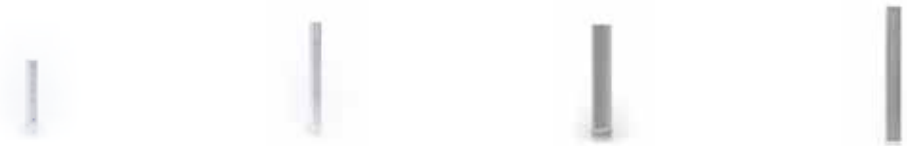

MODEL	CS 3041	CS 3082	CS 6520 EN	CS6940
TYPE	Column speaker two-way	Column speaker two-way	Column speaker two-way	Column speaker two-way
INSTALLATION	Wall	Wall	Wall	Wall
COLOUR	White	White	White	White
SPEAKER	4 x 2" + 1"	8 x 2" + 2 x 1"	4 x 3.15" + 0.8"	8 x 3.15" + 0.8"
POWER NOM./PROGRAM	15 W RMS / 30 W	30 W RMS / 60 W	20 W RMS / 40 W	40 W RMS / 80 W
INPUT	100 V, 70 V	100 V, 70 V	100 V, 70 V	100 V, 70 V
FREQUENCY RESPONSE	160 - 20.000 Hz (? 3 dB)	180 - 20.000 Hz (? 3 dB)	140 ÷ 20.000 Hz	160 ÷ 20.000 Hz
MAX. SOUND PRESSURE	105 dB (1 m / POWER MAX)	111 dB (1 m / POWER MAX)	105 dB	110 dB
ANGLE OF COVERAGE	180° (Horiz) 70° (Ver)	180° (Horiz) 50° (Ver)	180° (Horiz) 60° (Ver)	180° (Horiz) 40° (Ver)
PROTECTION	IP 40	IP 40	IP 66	IP 66



MODEL	MR 33T	MR 44T	MR 55	MQ 100L	MQ 90S
TYPE	Compact two-way	Compact two-way	Compact two-way	Column speaker Three-way	Subwoofer
INSTALLATION	Wall	Wall	Wall	Wall	Universal
COLOUR	White/Black	White/Black	White/Black	White/black	White/Black
SPEAKER	4.75" + 0.5"	5" + 0.5"	5" + 0.75"	2 x 3.5" + 2 x 3.5" + 0.75"	8"
POWER NOM./PROGRAM	40 W IEC	60 W IEC	175 W IEC	80 W RMS / 160 W	60 W RMS / 120 W
INPUT	100 V, 70 V, 50 V, 25 V	100 V, 70 V, 50 V, 25 V	4 Ω	100 V, 70 V	100 V, 70 V
FREQUENCY RESPONSE	160 ÷ 20.000 Hz	150 ÷ 20.000 Hz	150 ÷ 20.000 Hz	130 ÷ 20.000 Hz	70 ÷ 220 Hz
MAX. SOUND PRESSURE	105 dB	108 dB	112 dB	120 dB	107 dB
ANGLE OF COVERAGE	110° (Horiz) 100° (Ver)	110° (Horiz) 100° (Ver)	110° (Horiz) 100° (Ver)	180° (Horiz) 60° (Ver)	-
PROTECTION	IP40	IP40	IP40	IP40	IP40



MODEL	MQ 50	MQ 60H	MQ 50C	MQ 50I	MQ 30P	MQ 80P
TYPE	Compact two-way	Compact two-way	Ceiling two-way	Compact two-way	Compact two-way	Compact two-way
INSTALLATION	Wall	Wall	Ceiling	Flush mounted	Projector	Projector
COLOUR	White/Silver/Black	White/Silver/Black	White/Silver	White/Silver	White/Silver/Black	White/Silver/Black
SPEAKER	5" + 0.75"	5" + 2 x 1"	5" + 1"	5" + 0.75"	3" + 0.75"	5" + 1"
POWER NOM./PROGRAM	60 W RMS / 120 W	60 W RMS / 120 W	60 W RMS / 120 W	60 W RMS / 120 W	12 W RMS / 24 W	60 W RMS / 120 W
INPUT	100 V, 70 V	100 V, 70 V	100 V, 70 V	100 V, 70 V	100 V, 70 V	100 V, 70 V
FREQUENCY RESPONSE	70 ÷ 20.000 Hz	100 ÷ 19.000 Hz	70 ÷ 20.000 Hz	180 ÷ 20.000 Hz	150 ÷ 20.000 Hz	100 ÷ 20.000 Hz
MAX. SOUND PRESSURE	110dB	109 dB	112 dB	108 dB	102 dB	115 dB
ANGLE OF COVERAGE	120° (Horiz) 90° (Ver)	180° (Horiz) 120° (Ver)	120°	120° (Horiz) 100° (Ver)	120°	90° (Horiz) 60° (Ver)
PROTECTION	IP40	IP40	IP40	IP40	IP40	IP 55

DP 4

p/n 130.00.106

INDOOR / OUTDOOR SOUND PROJECTOR



1'300 g

↕ mm

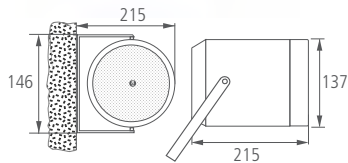

- Ideal for paging and background music
- 5" (130 mm) diameter extended range twin-cone loudspeaker
- Built-in multi-tapped transformer for 100 V constant voltage connection
- Equipped with aluminium "U" bracket.
- Body in ABS grey RAL 7035 with metal grill. IP55 protection, suitable for outdoor use

SPECIFICATIONS

DP 4

POWER	10 - 5 - 2.5 W (100 V)
CONSTANT VOLTAGE	100 V
FREQUENCY RESPONSE	180 ÷ 16.000 Hz (± 3 dB)
SENSITIVITY (1 m / 1 W)	91 dB
MAXIMUM SOUND PRESSURE	101 dB (1 m / POWER MAX)
ANGLE OF COVERAGE	130°

BD 42

p/n 130.00.247

INDOOR / OUTDOOR BIDIRECTIONAL SOUND PROJECTOR



1'500 g

↕ mm

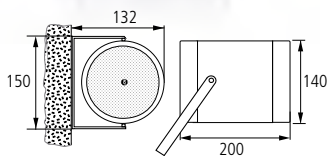

- Ideal for train and underground stations, car parks, factories, warehouses, and PA systems
- Bidirectional sound projector with double loudspeaker, characterized by high acoustic performance, excellent design and compact dimensions
- 2 x 5" (130 mm) diameter extended range twin-cone loudspeaker
- Built-in multi-tapped transformer for 100 V constant voltage connection
- Equipped with aluminium "U" bracket.
- Body in ABS grey RAL 7035 with metal grill. IP55 protection, suitable for outdoor use

SPECIFICATIONS

BD 42

POWER	12 - 6 - 3 W (100 V)
CONSTANT VOLTAGE	100 V
FREQUENCY RESPONSE	180 ÷ 16.000 Hz (± 3 dB)
SENSITIVITY (1 m / 1 W)	91 dB
MAXIMUM SOUND PRESSURE	102 dB (1 m / POWER MAX)
ANGLE OF COVERAGE	130° (per single loudspeaker)

DP 2X/1

TWO-WAY SOUND PROJECTOR



1'100 g

↕ mm

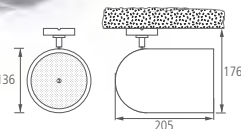

P/n 130.00.107

- Ideal for paging and background music
- 4 Ω input. Music power/RMS: 8/4W. 5" diameter extended range loudspeaker
- Equipped with hinged support to orient the speaker in any direction
- Body in ABS RAL 9003 white, metal grille white

SPECIFICATIONS

DP 2X/1

POWER	4-2-1 (100 V)
CONSTANT VOLTAGE	100 V
FREQUENCY RESPONSE	150 ÷ 18.000 Hz (± 3 dB)
SENSITIVITY (1 m / 1 W)	94 dB
MAXIMUM SOUND PRESSURE	102 dB (1 m / POWER MAX)
ANGLE OF COVERAGE	110°

DP 1420EN

ALUMINIUM SOUND PROJECTOR



2'500 g

↕ mm

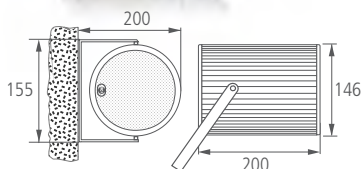

p/n 131.33.071

- Unidirectional sound projector characterized by high acoustic performance.
- Complying with EN 54-24 standard thanks to ceramic termination block, thermal fuse and internal fire-resistant cable
- IP 66 protection, suitable for outdoor use
- Ideal for train and underground stations, car parks, factories, warehouses, and PA systems

SPECIFICATIONS

DP 1420EN

POWER	20-10-5 W (100 V)
CONSTANT VOLTAGE	100 V, 70 V
FREQUENCY RESPONSE	150 ÷ 20.000 Hz (± 3 dB)
SENSITIVITY (1 m / 1 W)	91 dB
MAXIMUM SOUND PRESSURE	104 dB (1 m / POWER MAX) 2
ANGLE OF COVERAGE	160°



BD 2412 EN

p/n 131.33.074

ALUMINIUM BIDIRECTIONAL SOUND PROJECTOR



- Bidirectional sound projector with double loudspeaker, characterized by high acoustic performance, excellent design and compact dimensions
- Complying with EN 54-24 standard thanks to ceramic termination block, thermal fuse and internal fire-resistant cable
- IP 55 protection, suitable for outdoor use
- It's ideal for train stations, underground stations, car parks, factories, warehouses, and PA systems in general

3'200 g

↕ mm

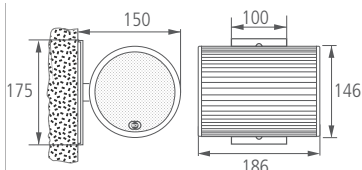

SPECIFICATIONS

BD 2412 EN

POWER	20-5-10 W (100 V)
CONSTANT VOLTAGE	100 V, 70 V
FREQUENCY RESPONSE	130 ÷ 20.000 Hz (± 3 dB)
SENSITIVITY (1 m / 1 W)	89 dB
MAXIMUM SOUND PRESSURE	102 dB (1 m / POWER MAX)
ANGLE OF COVERAGE	130° (per SINGLE LOUDSPEAKER)

DP 5EN

p/n 131.33.076



MONODIRECTIONAL PROJECTOR EN54-24 COMPLIANT

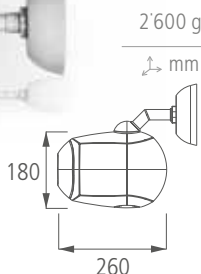

2'600 g

↕ mm

- 20W rated power with a 5" Full range transducer
- ABS UL 94Vo auto-extinguish plastic body and front grille made of steel
- IP66 protection grade, so suitable for both indoors and outdoors applications
- 4 power taps
- Orientable support bracket
- Colour white RAL 9016

SPECIFICATIONS

DP 5-EN

SELECTABLE POWER	20 W – 10 W – 5 W – 2.5 W (100 V) W RMS
CONSTANT VOLTAGE	100 V, 70 V
FREQUENCY RESPONSE	80 ÷ 20.000 Hz (± 3 dB)
SENSITIVITY (1 m / 1 W)	88 dB (1 W, 1 m), 76 dB (1 W, 4m) dB
MAXIMUM SOUND PRESSURE	101 dB (20 W, 1 m), 89 dB (20 W, 4 m) dB
ANGLE OF COVERAGE	160°

BD 5EN

p/n 131.33.077



BIDIRECTIONAL PROJECTOR EN54-24 COMPLIANT

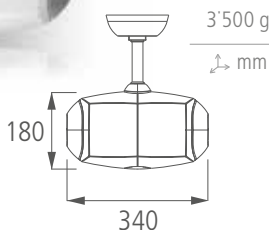

3'500 g

↕ mm

- 20W rated power with 2x5" Full range transducer
- ABS UL 94Vo auto-extinguish plastic body and front grille made of steel
- IP66 protection grade, so suitable for both indoors and outdoors applications
- 4 power taps
- Orientable support bracket
- Colour white RAL 9016

SPECIFICATIONS

BD 5-EN

SELECTABLE POWER	20 W – 10 W – 5 W – 2.5 W (100 V) W RMS
CONSTANT VOLTAGE	100 V, 70 V
FREQUENCY RESPONSE	150 ÷ 18.000 Hz (± 3 dB)
SENSITIVITY (1 m / 1 W)	86 dB (1 W, 1 m), 74 dB (1 W, 4m) dB
MAXIMUM SOUND PRESSURE	99 dB (20 W, 1 m), 87 dB (20 W, 4 m) dB
ANGLE OF COVERAGE	130° in both directions

CS 3041

SLIM-LINE COLUMN SPEAKER

p/n 130.00.231



1'700 g

mm

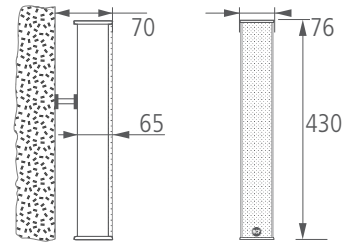

- Ideal for speech reproduction, shape designed to enable corner installation
- Four 50 mm (2") diameter extended range speakers and one tweeter 25 mm (1")
- Body in extruded aluminium bake-painted RAL 9016 White and front metal grille RAL 9016 White, includes accessory for wall mounting
- Built-in multi-tapped transformer (15 - 10 - 5 W) for 100 V constant voltage connection
- 16-ohm input that can be selected on the terminal block
- Audio connection on screw terminal block

SPECIFICATIONS

POWER	20 W - 15 W - 10 W
CONSTANT VOLTAGE	100 V
FREQUENCY RESPONSE	160 - 20.000 Hz (? 3 dB)
SENSITIVITY (1 m / 1 W)	87 dB
MAXIMUM SOUND PRESSURE	105 dB (1 m / POWER MAX)
ANGLE OF COVERAGE	180° (HORIZ.); 70° (VERT.)

CS 3041

CS 3082

SLIM-LINE COLUMN SPEAKER

p/n 130.00.232



2'700 g

mm

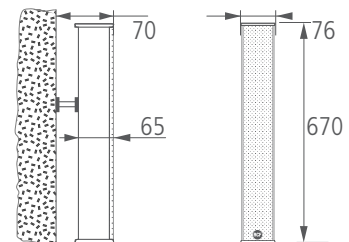

- Ideal for speech reproduction, shape designed to enable corner installation
- Eight 50 mm (2") diameter extended range speakers and two tweeter 25 mm (1")
- Body in extruded aluminium bake-painted RAL 9016 White and front metal grille RAL 9016 White, includes accessory for wall mounting
- Built-in multi-tapped transformer (30 - 20 - 10 W) for 100 V constant voltage connection
- 16-ohm input that can be selected on the terminal block
- Audio connection on screw terminal block

SPECIFICATIONS

POWER	30 W - 20 W - 10 W
CONSTANT VOLTAGE	100 V
FREQUENCY RESPONSE	180 - 20.000 Hz (? 3 dB)
SENSITIVITY (1 m / 1 W)	90 dB
MAXIMUM SOUND PRESSURE	111 dB (1 m / POWER MAX)
ANGLE OF COVERAGE	180° (HORIZ.); 30° (VERT.)

CS 3082

CS 6520 EN

TWO-WAY COLUMN SPEAKER

p/n 131.33.079

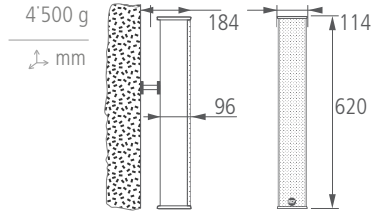

- Ideal for speech reproduction with high intelligibility in acoustically difficult environments, both indoors and outdoors, also suitable for music
- Four 3" mid-woofer speakers and one central 20mm tweeter
- Weather-resistant construction IP 66 for use also outdoors, sturdy hinged support in resin, stainless steel fasteners
- Body in aluminium and front grille in steel bake-painted RAL 9003 White
- Articulated support for wall mounting included
- CS 6520 EN column speaker, EN 54-24 norm compliant

SPECIFICATIONS

POWER	20 - 10 - 5 - 2,5 W (100 V)
CONSTANT VOLTAGE	100 V, 70 V
FREQUENCY RESPONSE	140 ÷ 20.000 Hz (± 3 dB)
SENSITIVITY (1 m / 1 W)	92 dB (1 W, 1m) - 80 dB (1 W, 4m)
MAXIMUM SOUND PRESSURE	105 dB (20 W, 1 m), 93 dB (20 W, 4 m)
ANGLE OF COVERAGE	185° (horiz.); 47° (vert.)

CS 6520 EN

POWER	20 - 10 - 5 - 2,5 W (100 V)
CONSTANT VOLTAGE	100 V, 70 V
FREQUENCY RESPONSE	140 ÷ 20.000 Hz (± 3 dB)
SENSITIVITY (1 m / 1 W)	92 dB (1 W, 1m) - 80 dB (1 W, 4m)
MAXIMUM SOUND PRESSURE	105 dB (20 W, 1 m), 93 dB (20 W, 4 m)
ANGLE OF COVERAGE	185° (horiz.); 47° (vert.)

CS 6940

HIGH DIRECTIVITY
TWO-WAY COLUMN SPEAKER

p/n 131.50.006



7'000 g
↕ mm

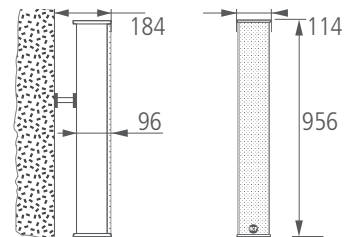

- Ideal for speech reproduction with high intelligibility in acoustically difficult environments, both indoors and outdoors, also suitable for music
- Eight 3" diameter speakers, one 20mm tweeter, filtered and connected for improved control of vertical dispersion
- Weather-resistant construction IP 66 for use also outdoors, sturdy hinged support in resin, stainless steel fasteners
- Body in aluminium and front grille in steel bake-painted RAL 9003 White
- Articulated support for wall mounting included

SPECIFICATIONS

POWER	40 - 20 - 10 - 5 W (100 V)
CONSTANT VOLTAGE	100 V, 70 V
FREQUENCY RESPONSE	160 ÷ 20.000 Hz (± 3 dB)
SENSITIVITY (1 m / 1 W)	94 dB
MAXIMUM SOUND PRESSURE	110 dB (1 m / POWER MAX)
ANGLE OF COVERAGE	180° (HORIZ.); 40° (VERT.)

CS 6940

POWER	40 - 20 - 10 - 5 W (100 V)
CONSTANT VOLTAGE	100 V, 70 V
FREQUENCY RESPONSE	160 ÷ 20.000 Hz (± 3 dB)
SENSITIVITY (1 m / 1 W)	94 dB
MAXIMUM SOUND PRESSURE	110 dB (1 m / POWER MAX)
ANGLE OF COVERAGE	180° (HORIZ.); 40° (VERT.)

AC WM-CS

COUPLE OF SWIVEL BRACKETS

p/n 133.60.206

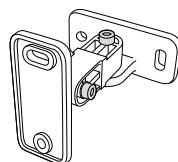

- Swivel brackets for the installation of CS 3041 and CS 3082 speakers

MR 33T MR 33WT

TWO-WAY COMPACT MONITOR SPEAKERS
WITH TRANSFORMER

MR 33T Black p/n 00.07.140

MR 33WT White p/n 00.07.141



2'200 g

↕ mm

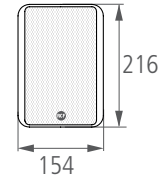
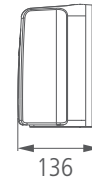

- Ideal for high quality paging and music reproduction
- Low impedance (4Ω - 40W) or 100V operating mode
- Two-way system, woofer with carbon fiber cone, 0.5" tweeter in Mylar on constant directivity horn
- Built-in low inductance passive crossover, bass reflex @150Hz
- Orientable mounting accessory included
- Body in self-extinguishing composite material, UV resistant

SPECIFICATIONS

POWER	20 - 10 - 5 - 2.5 - 1 W (100 V)
CONSTANT VOLTAGE	100 V, 70 V, 50 V, 25 V
FREQUENCY RESPONSE	160 ÷ 20.000 Hz (± 3 dB)
SENSITIVITY (1 m / 1 W)	88 dB
MAXIMUM SOUND PRESSURE	105 dB (1 m / POWER MAX)
ANGLE OF COVERAGE	110° (HORIZ.); 100° (VERT.)

MR 33T

MR 44T MR 44WT

TWO-WAY MONITOR SPEAKERS
WITH TRANSFORMER

MR 44T Black p/n 00.07.142

MR 44WT White p/n 00.07.354



3'600 g

↕ mm

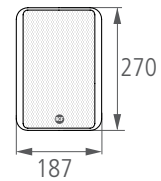
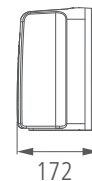

- Ideal for high quality paging and music reproduction
- Low impedance (4Ω - 60W) or 100V operating mode
- Transducers LF 5" - HF 0.5" constant directivity tweeter
- Built-in low inductance passive crossover with high frequency dynamic protection, bass reflex @65Hz
- Body in self-extinguishing plastic
- Includes hinged support for installation

SPECIFICATIONS

POWER	40 - 30 - 20 - 10 - 5 W (100 V)
CONSTANT VOLTAGE	100 V, 70 V, 50 V, 25 V
FREQUENCY RESPONSE	150 ÷ 20.000 Hz (± 3 dB)
SENSITIVITY (1 m / 1 W)	89 dB
MAXIMUM SOUND PRESSURE	108 dB (1 m / POWER MAX)
ANGLE OF COVERAGE	110° (HORIZ.); 100° (VERT.)

MONITOR 44T

MR 55 MR 55W

TWO-WAY HIGH DEFINITION
MONITOR SPEAKERS



MR 55 Black p/n 00.07.143

MR 55 White p/n 00.07.355

3'900 g
mm

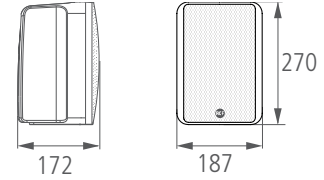

- Ideal for high quality paging and music reproduction
- Transducers LF 5" - HF 0.75" constant directivity tweeter
- Built-in low inductance passive crossover with high frequency dynamic protection, bass reflex @65Hz
- Body in self-extinguishing plastic
- Includes hinged support for installation

SPECIFICATIONS

NOMINAL POWER	175 W (IEC268-1)
SPEAKER IMPEDANCE	4 Ω
FREQUENCY RESPONSE	100 ÷ 19.000 Hz (± 3 dB)
SENSITIVITY (1 m / 1 W)	87 dB
MAXIMUM SOUND PRESSURE	112dB (1 m / POWER MAX)
ANGLE OF COVERAGE	110° (HORIZ.); 100° (VERT.)

MONITOR 55

NOMINAL POWER	175 W (IEC268-1)
SPEAKER IMPEDANCE	4 Ω
FREQUENCY RESPONSE	100 ÷ 19.000 Hz (± 3 dB)
SENSITIVITY (1 m / 1 W)	87 dB
MAXIMUM SOUND PRESSURE	112dB (1 m / POWER MAX)
ANGLE OF COVERAGE	110° (HORIZ.); 100° (VERT.)

MA 4X

ACCESSORIES

p/n 133.60.009

Wall mounting bracket for up to 4 Monitor Series cabinets models MR33T - MR44T - MR55 in cluster installations.

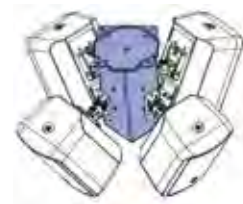

MA 3B - MA 3W

WALL MOUNT BRACKET

MA 3B Black p/n 00.08.056
MA 3W White p/n 00.08.057

Bracket for mounting one MR 33T speaker on the wall

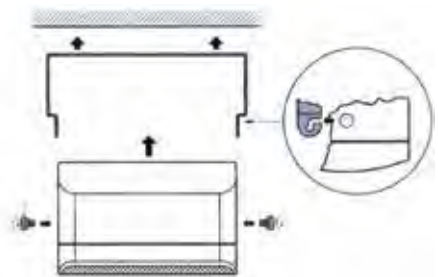

MA 5B - MA 5W

WALL MOUNT BRACKET

MA 5B Black p/n 00.08.058
MA 5W White p/n 00.08.059

Bracket for mounting one Monitor 44T or 55 series speaker on the wall

MQ 30P

MINIATURE TWO-WAY COAXIAL SPEAKER

MQ 30P-W White
p/n 130.00.058
MQ 30P-B Black
p/n 130.00.068



SPECIFICATIONS

POWER	12 - 6 W (100 V)
CONSTANT VOLTAGE	100 V, 70 V
FREQUENCY RESPONSE	150 ÷ 20.000 Hz (± 3 dB)
SENSITIVITY (1 m / 1 W)	88 dB
MAXIMUM SOUND PRESSURE	102 dB (1 m / POWER MAX)
ANGLE OF COVERAGE	120°

1'100 g

↕ mm

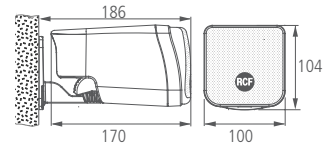

- Orientable mini-speaker for high quality reproduction
- Two way coaxial speaker: LF 3.5" - tweeter 0.75" dome
- Constant voltage: 70.7 - 100 V
- Impedance: [Bypass] 16 Ω
- Crossover frequencies: 5400 Hz, 6/6 dB/oct
- Built-in High-Pass filter at 150 Hz for integration with a subwoofer
- Cabinet: Hi-density polystyrene HB grade
- Connectors: Euroblock, removable for easy installation

MQ 30P

POWER	12 - 6 W (100 V)
CONSTANT VOLTAGE	100 V, 70 V
FREQUENCY RESPONSE	150 ÷ 20.000 Hz (± 3 dB)
SENSITIVITY (1 m / 1 W)	88 dB
MAXIMUM SOUND PRESSURE	102 dB (1 m / POWER MAX)
ANGLE OF COVERAGE	120°

MQ 80P

TWO-WAY INDOOR / OUTDOOR MONITOR

MQ 80P-W White
p/n 130.00.096
MQ 80P-B Black
p/n 130.00.094



SPECIFICATIONS

POWER	30 - 20 - 10 - 5 W (100 V)
CONSTANT VOLTAGE	100 V, 70 V
FREQUENCY RESPONSE	100 ÷ 20.000 Hz (± 3 dB)
SENSITIVITY (1 m / 1 W)	94 dB
MAXIMUM SOUND PRESSURE	115 dB (1 m / POWER MAX)
ANGLE OF COVERAGE	90° (HORIZ.); 60° (VERT.)

3'000 g

↕ mm

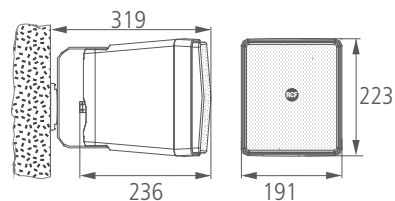

- Speaker: woofer 5" horn-loaded, 1" horn-loaded compression driver with phase-plug loaded on CD horn
- Impedance: [Bypass] 8 Ω
- [70.7V]: 15W - 10W - 5W - 2.5W
- Tuning frequency: 100 Hz
- Crossover frequency: 3000 Hz Crossover: Notch/6 dB/oct
- Cabinet: self-extinguishing high-density polystyrene, UV stabilized
- IP 55, suitable for outdoor use
- Suitable for cluster installation (2x, 3x) for a wide and uniform coverage

MQ 80P

POWER	30 - 20 - 10 - 5 W (100 V)
CONSTANT VOLTAGE	100 V, 70 V
FREQUENCY RESPONSE	100 ÷ 20.000 Hz (± 3 dB)
SENSITIVITY (1 m / 1 W)	94 dB
MAXIMUM SOUND PRESSURE	115 dB (1 m / POWER MAX)
ANGLE OF COVERAGE	90° (HORIZ.); 60° (VERT.)

MQ 50

TWO-WAY MONITOR

- MQ 50-W white p/n 130.00.056
- MQ 50-B black p/n 130.00.070

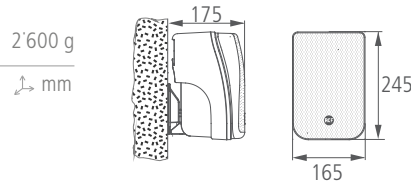

- Two way Bass reflex speaker for music reproduction
- Speaker: woofer 5" - tweeter 0.75" dome
- Impedance: [Bypass] 16 Ω
- Crossover frequencies: 4500 Hz, 12/12 dB/oct
- Protection: Dynamic on woofer and tweeter
- Cabinet: Hi-density polystyrene HB grade
- Connectors: Euroblock, removable for easy installation

SPECIFICATIONS

POWER	30 - 20 - 10 - 5 W (100 V)
CONSTANT VOLTAGE	100 V, 70 V
FREQUENCY RESPONSE	70 ÷ 20.000 Hz (± 3 dB)
SENSITIVITY (1 m / 1 W)	89 dB
MAXIMUM SOUND PRESSURE	110 dB (1 m / POWER MAX)
ANGLE OF COVERAGE	120° (HORIZ.); 90° (VERT.)

MQ 50

POWER	30 - 20 - 10 - 5 W (100 V)
CONSTANT VOLTAGE	100 V, 70 V
FREQUENCY RESPONSE	70 ÷ 20.000 Hz (± 3 dB)
SENSITIVITY (1 m / 1 W)	89 dB
MAXIMUM SOUND PRESSURE	110 dB (1 m / POWER MAX)
ANGLE OF COVERAGE	120° (HORIZ.); 90° (VERT.)

MQ 60H

WIDE DISPERSION CONSTANT DIRECTIVITY MONITOR

- MQ 60H-W white p/n 130.00.060
- MQ 60H-B black p/n 130.00.072



- Two way Bass reflex speaker for music reproduction
- Speaker: woofer 5" - tweeter 2 x 1" dome
- Impedance: [Bypass] 16 Ω
- Line transformer [100V]: 30W - 20W - 10W - 5W - [70.7V]: 15W - 10W - 5W - 2.5W
- Crossover frequencies: 2600 Hz. Crossover: 12/12 dB/oct
- Protection: Dynamic on woofer and tweeter
- Cabinet: Hi-density polystyrene HB grade
- Connectors: Euroblock, removable for easy installation

SPECIFICATIONS

POWER	30 - 20 - 10 - 5 W (100 V)
CONSTANT VOLTAGE	100 V, 70 V
FREQUENCY RESPONSE	100 ÷ 19.000 Hz (± 3 dB)
SENSITIVITY (1 m / 1 W)	88 dB
MAXIMUM SOUND PRESSURE	109 dB (1 m / POWER MAX)
ANGLE OF COVERAGE	180° (HORIZ.); 120° (VERT.)

MQ 60H

POWER	30 - 20 - 10 - 5 W (100 V)
CONSTANT VOLTAGE	100 V, 70 V
FREQUENCY RESPONSE	100 ÷ 19.000 Hz (± 3 dB)
SENSITIVITY (1 m / 1 W)	88 dB
MAXIMUM SOUND PRESSURE	109 dB (1 m / POWER MAX)
ANGLE OF COVERAGE	180° (HORIZ.); 120° (VERT.)

MQ 60H Link W

□ white p/n 133.60.080

MQ 60H Link B

■ black p/n 133.60.081

ACCESSORIES



- AC MQ60HLINK accessories, available in black or White can be used to support 2 MQ 60H speakers to form an Omni directional high quality speaker array (360°) dispersion over a horizontal surface which is controlled over a vertical surface.
- MQ 60H Link is made in fibre-glass loaded nylon and it is provided with the slide-insupports for the direct mounting of the two MQ 60H speaker systems.
- Central fixing ring for the safe suspension of the speaker assembly through a chain or a steel-wire.

MQ 50C

TWO-WAY CEILING MONITOR
SPEAKER

□ MQ 50C-W White
p/n 130.00.081



2'200 g

↕ mm

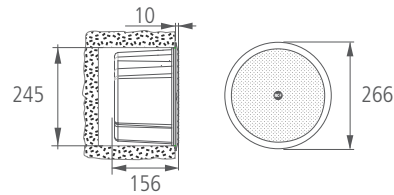

- Two way bass reflex ceiling speaker for music reproduction
- Speaker: woofer 5" neodymium magnet, tweeter 1" dome neodymium magnet
- Impedance: [Bypass] 16 Ω
- [70.7V]: 15W - 10W - 5W - 2.5 W
- Crossover frequencies: 3000 Hz, 12/12 dB/oct - High pass filter at 150 Hz
- Angle of coverage: 120° horizontal x 120° vertical
- Cabinet: Plastic material self-extinguishing, Tuned Alu-dome
- Connectors: Euroblock, removable for easy installation

SPECIFICATIONS

POWER	30 - 20 - 10 - 5 W (100 V)
CONSTANT VOLTAGE	100 V, 70 V
FREQUENCY RESPONSE	70 ÷ 20.000 Hz (± 3 dB)
SENSITIVITY (1 m / 1 W)	92 dB
MAXIMUM SOUND PRESSURE	112 dB (1 m / POWER MAX)
ANGLE OF COVERAGE	120°

MQ 50C

POWER	30 - 20 - 10 - 5 W (100 V)
CONSTANT VOLTAGE	100 V, 70 V
FREQUENCY RESPONSE	70 ÷ 20.000 Hz (± 3 dB)
SENSITIVITY (1 m / 1 W)	92 dB
MAXIMUM SOUND PRESSURE	112 dB (1 m / POWER MAX)
ANGLE OF COVERAGE	120°

MQ 50i

TWO-WAY IN WALL SPEAKER

□ MQ 50i-W White
p/n 130.00.139



3'000 g

↕ mm

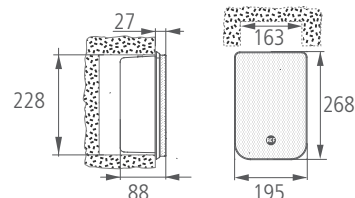

- In-wall speaker system for music reproduction
- Two way bass reflex construction for flush mount
- Speaker: woofer 5" neodymium magnet, 0.75" dome tweeter
- Impedance: [Bypass] 16 Ω
- [70.7V]: 15W - 10W - 5W - 2.5 W
- Crossover frequency: 3000 Hz, 12/12 dB/oct
- Cabinet: Plastic material self-extinguishing, Tuned Alu-dome
- Connectors: Euroblock
- Suitable for standard Multibox enclosure, 2 modules

SPECIFICATIONS

POWER	30 - 20 - 10 - 5 W (100 V)
CONSTANT VOLTAGE	100 V, 70 V
FREQUENCY RESPONSE	180 ÷ 20.000 Hz (± 3 dB)
SENSITIVITY (1 m / 1 W)	90 dB
MAXIMUM SOUND PRESSURE	108 dB (1 m / POWER MAX)
ANGLE OF COVERAGE	120° (HORIZ.); 100° (VERT.)

MQ 50i

POWER	30 - 20 - 10 - 5 W (100 V)
CONSTANT VOLTAGE	100 V, 70 V
FREQUENCY RESPONSE	180 ÷ 20.000 Hz (± 3 dB)
SENSITIVITY (1 m / 1 W)	90 dB
MAXIMUM SOUND PRESSURE	108 dB (1 m / POWER MAX)
ANGLE OF COVERAGE	120° (HORIZ.); 100° (VERT.)

MQ 90S-B
8" BAND PASS SUBWOOFER

p/n 130.00.097



8'000 g

↕ mm

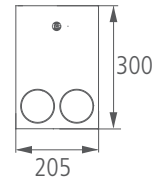
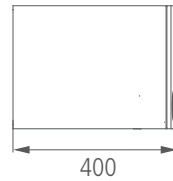

- Compact band-pass 8" subwoofer, especially designed to be used with MonitorQ series speakers
- Well suitable also for other RCF speakers such as PL40, PL6X, DU 100X, DP 2X
- The cabinet material is PVC covered with a scratch resistant surface and Painted Front Medium density
- Built-in multi-tapped transformer (60 – 30 – 7.5 W) for 100 V constant voltage connection
- 16-ohm input that can be selected by switch with MAX power 160 W / 80 W Bypass
- Internal Crossover filter at 200 Hz frequency 12 dB/oct
- As the subwoofer is non-directional, the unit can be installed in a semi-hidden position
- Connection through a removable Euroblock plug that allows the parallel connection of other loudspeakers.

SPECIFICATIONS

POWER	60 - 30 - 15 - 7.5 W (100 V)
CONSTANT VOLTAGE	100 V, 70 V
FREQUENCY RESPONSE	70 - 220 Hz (± 10 dB)
SENSITIVITY (1 m / 1 W)	89 dB
MAXIMUM SOUND PRESSURE	107 dB (1 m / POWER MAX)
CONNECTORS	EUROBLOCK

MQ 90S

POWER	60 - 30 - 15 - 7.5 W (100 V)
CONSTANT VOLTAGE	100 V, 70 V
FREQUENCY RESPONSE	70 - 220 Hz (± 10 dB)
SENSITIVITY (1 m / 1 W)	89 dB
MAXIMUM SOUND PRESSURE	107 dB (1 m / POWER MAX)
CONNECTORS	EUROBLOCK

MQ 100L-W
MQ 100L-B
3 WAYS COLUMN LOUDSPEAKER

MQ 100L-W White
p/n 130.00.187

MQ 100L Black
p/n 130.00.186



3'000 g

↕ mm

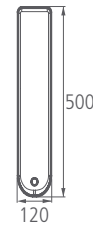
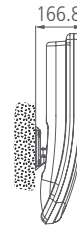

- 3 way column array speaker system providing natural high intelligibility hi-fidelity sound of both speech and music
- Body is made of self-extinguishing (HB level) high density polystyrene
- The wide horizontal coverage angle (180°) and the 60° asymmetrical vertical dispersion allow the correct sound reproduction and feedback reduction
- MQ 100L is equipped with: 2 rubber surround 3.5" woofers, 2 fabric surround 3.5" mid-woofers, 2 cloth coated 0.75" dome tweeters
- Mounting accessories are included. These have been studied to keep the column as close as possible to the wall and simplify its installation
- The pre-oriented vertical acoustic axis allows to cover already the majority of the installations.
- Provided with accessories to orient the speaker down of extra 5° and 10°
- Built-in multi-tapped transformer (40 – 20– 10 -5 W) for 100 V constant voltage connection
- 16-ohm input that can be selected by switch with MAX power 60 W

SPECIFICATIONS

POWER	120 - 60 W (100 V)
CONSTANT VOLTAGE	100 V, 70 V
FREQUENCY RESPONSE	130 - 20.000 Hz (± 3 dB)
SENSITIVITY (1 m / 1 W)	93 dB
MAXIMUM SOUND PRESSURE	120 dB (1 m / POWER MAX)
ANGLE OF COVERAGE	180° (HORIZ.); 60° (VERT.)

MQ 100L-W - MQ 100L-B

POWER	120 - 60 W (100 V)
CONSTANT VOLTAGE	100 V, 70 V
FREQUENCY RESPONSE	130 - 20.000 Hz (± 3 dB)
SENSITIVITY (1 m / 1 W)	93 dB
MAXIMUM SOUND PRESSURE	120 dB (1 m / POWER MAX)
ANGLE OF COVERAGE	180° (HORIZ.); 60° (VERT.)

HORN SPEAKERS

Designed to be weather resistant and to withstand high sound pressure levels outdoor or in large environments.



MODEL	HD 21 EN	HD 216/ST	HD 1110	H6045 (4 DRIVER D5076)	HD 6045 EN
TYPE	Round	Round	Round	Rectangular	Rectangular
MATERIAL	ABS	Die-Cast Aluminium	ABS	Fiberglass	Fiberglass
POWER NOM./PROGRAM	30 W RMS	20 W RMS / 30 W	20 W RMS / 30 W	200 W RMS / 300 W	200 W RMS
INPUT	100 V - 70 V	100 V - 70 V - 25 V	8 Ω	100 V - 70 V - 25 V	100 V - 70 V - 25 V
FREQUENCY RESPONSE	340 Hz ÷ 9 kHz	350 ÷ 15.000 Hz	900 ÷ 13.000 Hz	150 ÷ 12.000 Hz	200 ÷ 10.000 Hz
MAX. SOUND PRESSURE	119dB	123dB	116 dB	132 dB	139 dB
ANGLE OF COVERAGE	210° - 135° - 70° - 40°	80°	180°	60° (Horiz) 50° (Ver)	60° (Horiz) 50° (Ver)
PROTECTION / NORM	IP 66	IP 55	IP 65	IP 54	IP 65



MODEL	HD 210/TY	HD 310/T	HD 410/T	HD 3216/T
TYPE	Round	Round	Round	Rectangular
MATERIAL	Aluminium	Aluminium	Aluminium	ABS
POWER NOM./PROGRAM	20 W RMS / 30 W	30 W RMS / 45 W	50 W RMS / 75W	25 W RMS / 38 W
INPUT	100 V - 70 V	100 V - 70 V	100 V - 70 V	100 V - 70 V
FREQUENCY RESPONSE	300 ÷ 9.000 Hz	240 ÷ 10.000 Hz	180 ÷ 7.000 Hz	250 ÷ 10.000 Hz
MAX. SOUND PRESSURE	121 dB	123 dB	130 dB	122 dB
ANGLE OF COVERAGE	70°	80°	80°	60° (Horiz) 130° (Ver)
PROTECTION	IP 66	IP 66	IP 66	IP 66

HD 21 EN

PLASTIC HORN SPEAKER WITH DRIVER

2'050 g

↕ Ø 211 x 280 mm



p/n 131.33.075

- Compact speaker with 30 W driver in compliance with EN 54-24
- Rear cover in UV stabilised self-extinguishing ABS
- Suitable for indoor and outdoor use (thanks to IP 66 protection)
- Transformer for 100 V (/ 70 V) constant voltage connection
- Thermal fuse to protect the audio line from heat
- Ceramic terminals for linking input and output cable
- Swiveling bracket included
- Color: light gray

SPECIFICATIONS	HD 21 EN
NOMINAL POWER (MAX)	30 W RMS
SELECTABLE POWER	30 - 15 - 7,5 - 3,75 W (100 V) / 15 - 7,5 - 3,75 - 1,875 W (70 V)
INPUT IMPEDANCE	333 Ω (30 W-100 V / 15 W-70 V) 667 Ω (15 W-100 V / 7,5 W-70 V) 1,33 kΩ (7,5 W-100 V / 3,75 W-70 V) 2,67 kΩ (3,75 W-100 V / 1,875 W-70 V)
FREQUENCY RESPONSE	340 Hz ÷ 9 kHz
SENSITIVITY	104 dB (1 W / 1 m), 92 dB (1 W / 4 m)
COVERAGE ANGLE (-6 dB)	210° (500 Hz), 135° (1kHz), 70° (2kHz), 40° (4 kHz)
SOUND PRESSURE (MAX)	119 dB (30 W, 1 m), 107 dB (30 W, 4 m)

HD 3216

PLASTIC HORN SPEAKER WITH DRIVER

2'100 g

↕ 310x 165 x 290 mm



p/n 131.33.039

- IP 66 double isolation; for temperatures between -25°C and + 70°C
- UV-stabilized autoextinguishing UL-HB ABS plastic.
- Hi-pass filter for protecting driver against out-of-range low-freq.
- Color:RAL 7035 (platinum gray)
- Stainless-Steel mounting hardware

SPECIFICATIONS	HD 3216
NOMINAL POWER (MAX)	25 W RMS / 38 W
SELECTABLE POWER	-
INPUT IMPEDANCE	8 Ω
FREQUENCY RESPONSE	250 ÷ 10.000 Hz (± 3 dB)
SENSITIVITY	106 dB
COVERAGE ANGLE (-6 dB)	60° (HORIZ.); 50° (VERT.)
SOUND PRESSURE (MAX)	122 dB (1 m / POT. MAX)

HD 3216/T

COMPACT HORN SPEAKER

2'500 g

↕ 310 x 165 x 320 mm



p/n 131.33.037



- Compact speaker with high directivity and efficiency for intelligible speech reproduction
- Driver impedance 8 Ω
- Selector accessible on rear cover
- IP 66 double insulation construction for temperatures between -25°C and +70°C
- High-pass filter for protection of the driver against low frequencies out of range
- Body in UV stabilised self-extinguishing ABS, RAL 7035 grey
- Stainless steel attachment bracket included

SPECIFICATIONS	HD 3216/T
POWER	25 W RMS – 38 W MAX
CONSTANT VOLTAGE	25-20-15-10-5 W
FREQUENCY RESPONSE	100 V; 70V
SENSITIVITY (1 m / 1 W)	250 ÷ 10.000 Hz (± 3 dB)
MAXIMUM SOUND PRESSURE	106 dB
ANGLE OF COVERAGE	60° (HORIZ.); 50° (VERT.)

ST 7300

UNIVERSAL VEHICLE SUPPORT FOR HORN SPEAKERS



p/n 133.20.036

- Chrome steel universal support for the installation of a horn speaker on a car top. Designed for the installation on the luggage rack, it offers the possibility to rotate the horn speaker up to 160°, to steer the sound to the desired direction.
- Dimensions: 230 x 90 x 18 mm. Weight: 0,5 Kg

HD 210/TY

ALUMINIUM HORN SPEAKER WITH DRIVER

p/n 0007057

2'200 g

↕ ↗ Ø 212 x 290 mm



- Compact speaker with high directivity and efficiency for intelligible speech reproduction
- IP 66 double insulation construction, suitable for outdoor use for temperature between -25°C and +70°C
- High-pass filter for protection of the driver against low frequencies out of range
- Driver impedance 8 Ω
- Rear cover in UV stabilised self-extinguishing ABS, RAL 7035 grey
- Stainless steel attachment bracket included

SPECIFICATIONS

HD 210/TY

POWER	20 - 10 - 5 - 2.5 W (100 V)
CONSTANT VOLTAGE	100 V; 70 V
FREQUENCY RESPONSE	300 ÷ 9.000 Hz (± 3 dB)
SENSITIVITY (1 m / 1 W)	108 dB
MAXIMUM SOUND PRESSURE	121 dB (1 m / POWER MAX)
ANGLE OF COVERAGE	70° (HORIZ. AND VERT.)

HD 310/T

ALUMINIUM HORN SPEAKER WITH DRIVER

p/n 131.30.001

3'100 g

↕ ↗ Ø 310 x 315 mm



- High efficiency speaker ideal for speech reproduction
- Weather-resistant construction IP 66 Rating, suitable for outdoor use for temperatures between -25°C and +70°C
- High-pass filter for protection of the driver against low frequencies out of range
- Driver impedance 8 Ω
- Stainless steel attachment bracket included
- Rear cover in UV stabilised self-extinguishing ABS, RAL 7035 grey

SPECIFICATIONS

HD 310/T

POWER	30 - 20 - 15 - 10 - 5 W (100 V)
CONSTANT VOLTAGE	100 V; 70 V
FREQUENCY RESPONSE	240 ÷ 10.000 Hz (± 3 dB)
SENSITIVITY (1 m / 1 W)	108 dB
MAXIMUM SOUND PRESSURE	123 dB (1 m / POWER MAX)
ANGLE OF COVERAGE	80° (HORIZ. AND VERT.)

HD 410/T

ALUMINIUM HORN SPEAKER WITH DRIVER AND TRANSFORMER

p/n 131.33.041

4'100 g

↕ ↗ Ø 410 x 385 mm



- High efficiency speaker ideal for speech reproduction
- Weather-resistant construction IP 66 Rating, suitable for outdoor use for temperatures between -25°C and +70°C
- High-pass filter for protection of the driver against low frequencies out of range
- Driver impedance 16 Ω
- Stainless steel attachment bracket included
- Rear cover in UV stabilised self-extinguishing ABS, RAL 7035 grey

SPECIFICATIONS

HD 410/T

POWER	50 - 30 - 25 - 15 W (100 V)
CONSTANT VOLTAGE	100 V; 70 V
FREQUENCY RESPONSE	180 ÷ 7.000 Hz (± 3 dB)
SENSITIVITY (1 m / 1 W)	112 dB
MAXIMUM SOUND PRESSURE	130 dB (1 m / POWER MAX)
ANGLE OF COVERAGE	80° (HORIZ. AND VERT.)

HD 216/ST

DIE CAST ALUMINIUM HORN SPEAKER

p/n 131.30.035

3'200 g
↕ ∅ 215 x 300 mm



- High efficiency speaker ideal for speech reproduction
- Music power/RMS: 30/20W
- Driver impedance 16 Ω
- Construction in pressure die-cast aluminium, weather-resistant IP 55 for outdoor use
- Attachment bracket included
- Colour: RAL 7035 grey

SPECIFICATIONS	HD 216/ST
SELECTABLE POWER	20 - 10 - 5 - 2,5 W (100 V)
POWER HANDLING	100 V; 70 V; 25 V
FREQUENCY RESPONSE	350 ÷ 15.000 Hz (± 3 dB)
SENSITIVITY (1 m / 1 W)	108 dB
MAX SPL	123 dB (1 m / MAX)
COVERAGE ANGLE	80° (HORIZONTAL AND VERTICAL)

HD 1110

HORN SPEAKERS WITH DYNAMIC DRIVER UNIT

p/n 131.33.030



- For alarm and paging systems in places with a high level of background noise
- High-pass filter for protection of the driver against low frequencies out of range
- Body in plastic, RAL 7035 grey
- Suitable for outdoor use
- Attachment steel bracket included

SPECIFICATIONS	HD 1110
POWER	20 W RMS - 30 W MAX
SPEAKER IMPEDANCE	8 Ω
FREQUENCY RESPONSE	900 ÷ 13.000 Hz (± 3 dB)
SENSITIVITY (1 m / 1 W)	101 dB
MAXIMUM SOUND PRESSURE	116 dB (1 m / POWER MAX)
ANGLE OF COVERAGE	180° (HORIZ. AND VERT.)

HD 6045 EN

H 6045

LONG-THROW MULTI CELL HORN SPEAKER

p/n 131.33.085



p/n 131.20.011



- High power, efficiency and directivity for intelligible speech reproduction
- To be used in combination with four D5076 drivers (H 6045 only)
- Sturdy construction, suitable for outdoor use in harsh weather conditions
- Body in fibreglass, RAL 9003 grey
- Attachment bracket included

SPECIFICATIONS	HD 6045 EN	H 6045
POWER	200 W RMS	200 W RMS
CONSTANT VOLTAGE	100 V	100 V; 70 V; 25 V
FREQUENCY RESPONSE	200 ÷ 12.000 Hz (± 3 dB)	150 ÷ 12.000 Hz (± 3 dB)
SENSITIVITY (1 m / 1 W)	110 dB	101 dB
MAXIMUM SOUND PRESSURE	139 dB	132 dB
ANGLE OF COVERAGE	60° (HORIZ.); 50° (VERT.)	60° (HORIZ.); 50° (VERT.)

D 5076

DRIVER UNIT

p/n. 151.10.017

- Musical power/RMS: 75/50W
- 1 3/8" W - 18 N threaded horn attachment
- Pressure die-cast compression chamber
- Driver impedance 16 Ω
- Dimensions ∅ 98 x 75 mm, weight 1.7 Kg
- Optional TD 507 line transformer



TD 507

50 V MULTI-TAPPED TRANSFORMER

p/n 133.30.006

- 50V Multi-tapped line transformer
- Suitable for connecting the D 5076 driver to 100/70V constant voltage lines
- Output power can be selected from four different values: 50-25-12-6W



ATTENUATORS, AUDIO TRANSFORMERS AND ACCESSORIES

To adjust the settings of the audio system according to any needs.



ATTENUATORS (SWITCHERS)

- The volume control is made of a control circuit having a 6 position (5 + off) selector and a separated transformer
- Installed on whichever supporting frame for home / office electrical systems by drilling a hole in a blank key and fixing its control circuit
- 3 knobs are included in 3 different colours: white, silver, anthracite
- The maximum depth of the volume control circuits are measured between the inner side of the front panel

IM 2220

p/n 133.60.089

PORTABLE IMPEDANCE TESTER



- The IM 2220 is a portable instrument, easy to use for measuring the impedance of the constant voltage speaker lines or of a single loudspeaker.
- The test range is quite wide thanks to the three measure fields (20 Ohm, 200 Ohm, 2000 Ohm). It is suitable for both commercial audio and domestic use.
- The IM 2220 is easy to use, comfortable and safe, thanks to the large control knob, to the large display and the high insulation.
- Meets IEC-1010 (EN 61010); CAT III 100V
- Display 3 ½ digit LCD
- Data HOLD indication
- Automatic switch-off of the pilot tone after 20s unless the LOCK key is pressed
- Automatic switch-off of the device after 15 minutes without being used

SPECIFICATIONS

SIGNAL TEST FREQUENCY

ACCURACY

ALTITUDE

OPERATING TEMPERATURE

POWER SUPPLY

DIMENSIONS

WEIGHT

IM 2220

1 kHz

± 2%

2000 m (~ 6500 ft)

0 ÷ 40°C (32 ÷ 104 °F)

9 V c.c (6 x 1.5 V AA, ALCALINE)

168 x 110 x 62 mm

0.5 Kg

AT 10Z CONSTANT IMPEDANCE ATTENUATOR | p/n 131.60.032



- Constant impedance attenuator for speakers with minimum impedance 4 Ω
- Universal mounting on any standard European electrical wall plate.
- 5 selectable positions + OFF volume control

SPECIFICATIONS	AT 10Z
IN/OUT IMPEDANCE	4 Ω
MAX. POWER	10 W
ATTENUATION	0 dB - 6 dB - 12 dB - 18 dB - 24 dB - OFF
MAX. DEPTH	50 mm

AT 20T 20 W / 100 V TRANSFORMER ATTENUATOR | p/n 131.60.033



- Attenuator for constant voltage systems, max 20W
- Universal mounting on any standard European electrical wall plate.
- 5 selectable positions + OFF volume control
- Bypass relay or 3-wire control system for alarm/evac applications

SPECIFICATIONS	AT 20T
INPUT VOLTAGE	100 V
MAX. POWER	20 W
ATTENUATION	0 dB - 3 dB - 6 dB - 9 dB - 12 dB - OFF
MAX. DEPTH	50 mm

AT 40T 40 W / 100 V TRANSFORMER ATTENUATOR | p/n 131.60.035



- Attenuator for constant voltage systems, max 20W
- Universal mounting on any standard European electrical wall plate.
- 5 selectable positions + OFF volume control
- Bypass relay or 3-wire control system for alarm/evac applications

SPECIFICATIONS	AT 40T
INPUT VOLTAGE	100 V
MAX. POWER	40 W
ATTENUATION	0 dB - 3 dB - 6 dB - 9 dB - 12 dB - OFF
MAX. DEPTH	58 mm

CT 61 6 POSITION 1 WAY ROTARY SWITCHER | p/n 131.60.036



- 5 selectable position + OFF volume control
- To be used with TL 128 autotransformer
- Bypass relay or 3-wire control system for alarm/evac applications

SPECIFICATIONS	CT 61
INPUT VOLTAGE	100 V
MAX. POWER	120 W
MAX. DEPTH	58 mm

TL 128 120 W LINE TRANSFORMER | P/n 133.60.050

1'140 g
↕ 68 x 72 x 85 mm



- The TL 128 transformer can be used in audio systems with constant voltage lines (usually 100 or 70V) to regulate the power of one or more acoustic speakers that have line transformers with a combined power of a maximum of 120 W
- It can be combined with a switch (up to 8 positions), in order to form a volume control that fades at 3 dB intervals

SPECIFICATIONS	TL 128
INPUT VOLTAGE	100 - 70 - 50 - 35 - 25 - 18 - 12 V
MAX. POWER	120 W
MINIMUM LOAD IMPEDANCE	83.3 - 41.7 - 20.8 - 10.4 - 5.2 - 2.6 - 1.3 Ω
FREQUENCY RESPONSE	60 ; 18.000 Hz (± 3 dB)

CP 52 5 POSITION 2 WAY ROTARY SWITCHER | p/n 131.60.034



- 5 Line selector for 100V system, load max 120W
- Bypass relay for emergency calls on line 1

SPECIFICATIONS	CP 52
MAX INPUT VOLTAGE	100 V
MAX. POWER	120 W
MAX. DEPTH	58 mm

UNIVERSAL LINE TRANSFORMERS

- High quality transformers suitable to connect loudspeakers with 4-8 Ω impedance (TD 105 excluded) to constant voltage lines (70-100V). It's possible to select different power values choosing different outputs.
- Thanks to material over-sizing and alternate layer windings, they offer high performance: dynamics and frequency response are particularly extended. They are suitable to drive professional speakers through constant voltage power amplifiers (TD 105 excluded)

TD 10 10 W UNIVERSAL LINE TRANSFORMER

p/n 133.60.045



SPECIFICATIONS

TD 10

OUTPUT POWER 4 Ω	1.2 - 2.5 - 5 - 10 W
OUTPUT POWER 8 Ω	0.6 - 1.2 - 2.5 - 5 - 10 W
FREQUENCY RESPONSE	50÷18'000 Hz
DIMENSIONS	86 x 53 x 59 mm
WEIGHT	500 g

TD 30 30 W UNIVERSAL LINE TRANSFORMER

p/n 133.60.046



SPECIFICATIONS

TD 30

OUTPUT POWER 4 Ω	15 - 30 W
OUTPUT POWER 8 Ω	7.5 - 15 - 30 W
FREQUENCY RESPONSE	50÷18'000 Hz
DIMENSIONS	87 x 53 x 68 mm
WEIGHT	700 g

TD 60 60 W UNIVERSAL LINE TRANSFORMER

p/n 133.60.047



SPECIFICATIONS

TD 60

OUTPUT POWER 4 Ω	15 - 30 - 60 W
OUTPUT POWER 8 Ω	7.5 - 15 - 30 - 60 W
FREQUENCY RESPONSE	50÷18'000 Hz
DIMENSIONS	77 x 77 x 79 mm
WEIGHT	1200 g

TD 120 120 W UNIVERSAL LINE TRANSFORMER

p/n 133.60.048



SPECIFICATIONS

TD 120

OUTPUT POWER 4 Ω	30 - 60 - 120 W
OUTPUT POWER 8 Ω	15 - 30 - 60 - 120 W
FREQUENCY RESPONSE	50÷18'000 Hz
DIMENSIONS	85 x 85 x 90 mm
WEIGHT	1900 g

TD 240 240 W UNIVERSAL LINE TRANSFORMER

p/n 133.60.049



SPECIFICATIONS

TD 240

OUTPUT POWER 4 Ω	60 - 120 - 240 W
OUTPUT POWER 8 Ω	30 - 60 - 120 - 240 W
FREQUENCY RESPONSE	50÷18'000 Hz
DIMENSIONS	98 x 89 x 100 mm
WEIGHT	3100 g

MOBILE AMPLIFICATION

Portable systems for all the situations in which mobility is important.



MG 90 10W MEGAPHONE

| p/n 131 33 081



- Extra strong plastic material, highly resistant to dust and humidity
- High intelligibility and speech clarity thanks to the microphone optimization.
- Built-in amplifier and dynamic unit
- Designed to be used even in critical situations
- 500 meters indicative range
- Activating button and volume located on the megaphone grip
- Power supply: 6 "AA" batteries (not included)
- Black body and grip, transparent pavilion

SPECIFICATIONS

NOMINAL POWER

POWER SUPPLY

TIME OF USE

BEAM OF USE

DIMENSIONS

WEIGHT

MG 90

10 W

6 AA Batteries (UM-3) (9V DC)

10 ore (talking)

0.45 Km (quiet ambient), 0.25 Km (city)

185 mm / 310 mm (diameter)

0,9 Kg (without batteries)

RACK COMPONENTS

For the optimum management of the system configurations.



MODEL	CR 2609	CR 2615	CR 2615 FV	CR 2628	CR 2642
PART NUMBER	171.70.179	171.70.080	171.70.129	171.70.081	171.70.082
TYPE	9 U	15 U	15 U	28 U	42 U
BASE DIMENSIONS	600 x 500 mm	600 x 600 mm	600 x 600 mm	600 x 600 mm	600 x 600 mm
HEIGHT	470 mm	800 mm	800 mm	1600 mm	2000 mm
WEIGHT	24 Kg	26 Kg	30 Kg	54 Kg	68 Kg
MAX LOAD	25 Kg	105 Kg	100 Kg	320 Kg	350 Kg
VENTILATION	Side natural ventilation	-	Thermostat controlled	Thermostat controlled	Thermostat controlled
Thermal Dissipation 25 °C	100 W	230 W	3130 W	3280 W	3320 W
Thermal Dissipation 35 °C	150 W	140 W	2070 W	2160 W	2180 W
INCLUDED ACCESSORIES	-	4 wheels with braking system	4 wheels with braking system	-	-
MODEL DOOR	(included)	AK 2615	AK 2615	AK 2628	AK 2642
PART NUMBER DOOR	-	(173.60.028)	(173.60.028)	(173.60.029)	(173.60.030)

CR 2600

RACK ENCLOSURES



- The CR 2600 series rack enclosures are designed to hold all RCF 19" rack standard components.
- They are constructed in compliance with the IEC 297-2 dimensional standard, and the depth is 600 mm for all models.
- The structure is made of steel painted RAL 7035 light grey. The rack enclosures are bake-painted at high temperature using epoxy powders to make the structure unalterable over time and resistant to scratching, abrasion, and atmospheric agents.
- The protection level is IP 30. The CR 2600 SERIES rack enclosures are composed of a basic structure that is assembled simply and quickly by fitting and securing four steel uprights to the upper and lower panels.
- The lower door and side panels are fitted following the wiring operations to facilitate the insertion and connection of the components. The lower panel, which forms the base of the rack, has openings for the passage of external connection cables (speaker lines, power supply, data, etc.) that are sized and shaped to guarantee the electrical safety of the structure. The earthing of the rack complies with current safety regulations.
- For the optimisation of the internal wiring, supports are supplied to gather the cable and attach them in an orderly fashion. The packing materials can be reused for transport the enclosure once it has been wired.
- Front doors are also available, which are useful for to protect the components installed in the rack.

CR 2609

p/n 171.70.179

9 UNITS RACK ENCLOSURE STANDARD
19" WITH TRANSPARENT DOOR



- Steel constructed structure
- Glass front door
- Removable rear panel
- Equipped assembled
- Dimensions: (B x P x H) 600 x 500 x 470 mm - Color RAL 7035

CLOSURE PANELS

PU 1

p/n 171.70.145



- 1U Closure Panel
- RAL 9005 Nero

PU 2

p/n 171.70.146

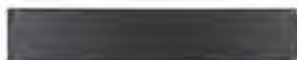

- 2U Closure Panel
- RAL 9005 Nero

PU 3

p/n 171.70.147



- 3U Closure Panel
- RAL 9005 Nero

PU 4

p/n 171.70.148



- 4U Closure Panel
- RAL 9005 Nero

PV 2603

VENTILATION UNIT

p/n171.70.137



5'000 g

↕ mm

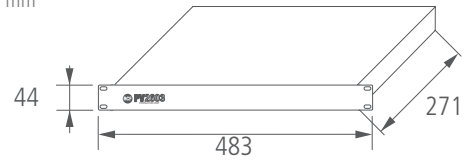

- PV 2603 is a ventilation unit composed by 3 blowers (230 V ac) and a main switch. The blowers turn on due to the activation command of a thermostat included in all RCF CR 2600 rack cabinets series.
- The ventilation unit has an air flow capacity of 500 m³/h
- 9" Rack mounting, 1 unit
- Main switch placed on the rear panel
- Low noise

RR 2601

RACK WHEELS KIT

p/n 173.60.038



- Wheels for RCF rack cabinets CR 2628 and CR 2642.
- The kit includes 2 wheels with brake and 2 swivel wheels. Wheel diameter: 80 mm .
- The maximum applicable load does not change when wheels are mounted.

AR 2605

FRAME WITH POWER SOCKETS

p/n 173.60.027



- 5-socket frame, Schuko and Italian standard, on back-rack support 2U.
- Portion of Omega bar for installing 5 Omega standard modules
- 16A total capacity; cable included

AR 1050

RACK SUPPORTS

p/n 173.60.039



- 1 U accessory for installation in RCF CR2600 series racks

BH 1042

BATTERY HOLDER

p/n 173.60.040



- Universal battery holder for RCF series "CR2600"

PAER1

FRONT VENTILATION PANELS

p/n 171.30.149



- Front ventilation panel, 1U for CR 2600 series racks, RAL 7021 gray

RT 2006

| p/n 171.70.125

RACK CONNECTIONS FOR POWER TRANSFORMERS
TD 300-TD 500-TD 1000



2'700 g

↕ mm

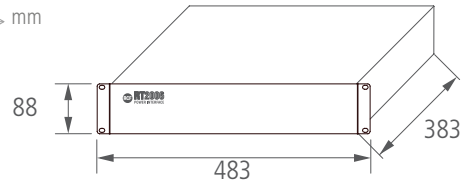

- The RT 2006 is a 2 standard unit 19" high rack container to house and connect up to 6 TD 300 transformers, 4 model TD 500 transformers or 2 TD 1000 transformers.
- Different transformers can also be combined within the transformer panel.
- The RT 2006 has an interface circuit with connection terminals between amplifiers, transformers and speaker lines.
- The connections are all removable and sized for maximum applicable power.
- Easy transformer installation and connection to terminals
- Thanks to material over-sizing and alternate layer windings, frequency response of the transformers is particularly extended. These transformers can be used also with professional high performance loudspeakers.

SPECIFICATIONS

INPUT IMPEDANCE (PRIMARY)	4 Ω (35 V - TD 300); 45 V - TD 500; 63 V - TD 1000)
OUTPUT VOLTAGE (SECONDARY)	100 V (33 Ω - TD 300); 20 Ω - TD 500; 10 Ω - TD 1000)
FREQUENCY RESPONSE	50 - 20.000 Hz
THERMAL DETECTION THRESHOLD	90° C
NOMINAL POWER	300 VA (TD 300); 500 VA (TD 500); 1000 VA (TD 1000)
DIMENSIONS (DIAMETER, HEIGHT)	ø 115 mm, 65 mm (TD 300); ø 125 mm, 70 mm (TD 500); ø 170 mm, 75 mm (TD 300)
NET WEIGHT	2.7 kg (TD 300); 3.3 kg (TD 500); 7.2 kg (TD 1000)
INPUT CONNECTORS	SPEAKON (RT 2006)
OUTPUT CONNECTORS	SCREW TYPE EUROBLOCK (RT 2006)

TD 300 - TD 500 - TD 1000

TD 300

| p/n 171.70.126

300W PROFESSIONAL AUDIO TOROIDAL TRANSFORMER

TD 500

| p/n 171.70.127

500W PROFESSIONAL AUDIO TOROIDAL TRANSFORMER

TD 1000

| p/n 171.70.128

1000W PROFESSIONAL AUDIO TOROIDAL TRANSFORMER



Nominal 300W TD 300 Toroidal transformer, main 4Ω, secondary 100V
Terminals for quick connection to panel RT 2006
Quick transformer mounting inside the rack chassis with the supplied kit

Nominal 500W TD 500 Toroidal transformer, main 4Ω, secondary 100V
Terminals for quick connection to panel RT 2006
Quick transformer mounting inside the rack chassis with the supplied kit.

Nominal 1000W TD 1000 Toroidal transformer, main 4Ω, secondary 100V
Terminals for quick connection to panel RT 2006
Quick transformer mounting inside the rack chassis with the supplied kit

HEADQUARTERS:

RCF S.p.A. Italy
tel. +39 0522 274 411
e-mail: info@rcf.it

RCF UK
tel. 0844 745 1234
Int. +44 870 626 3142
e-mail: info@rcfaudio.co.uk

RCF France
tel. +33 1 49 01 02 31
e-mail: france@rcf.it

RCF Germany
tel. +49 2203 925370
e-mail: germany@rcf.it

RCF Spain
tel. +34 91 817 42 66
e-mail: info@rcfaudio.es

RCF Benelux
tel. +49 (0) 2203 9253724
e-mail: benelux@rcf.it

RCF USA Inc.
tel. +1 732-9026100
e-mail: info@rcf-usa.com

www.rcf.it